

READY REFERENCE GUIDE

Generation • Distribution • Transmission

Who is TE?

We are a reliable provider of energy solutions for any environment. With a focus on employee expertise and durable products, we deliver the solutions and support our customers can count on under any circumstance. We support the generation, transmission and distribution of electricity in a wide array of industries, applications and environments around the world. Through our well-known product families Raychem, Simel, AMP and Bowthorpe EMP, we work collaboratively with you, our customers to tackle your toughest challenges by providing engineering support, qualified products and extraordinary customer experiences.

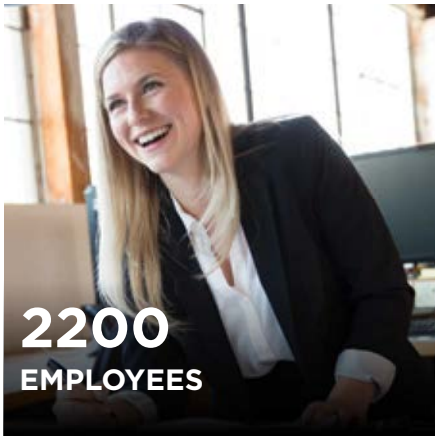

1K+
Patents
granted or pending

50
Countries

40K Products

Product Portfolio

CABLE ACCESSORIES

Our comprehensive range of cable accessories maintains service reliability in environmental extremes and can be used in both overhead and underground installations. TE and TE's Raychem power cable accessories have been trusted for over 60 years in industries and utilities such as underground, substations, offshore, nuclear and renewable.

CONNECTORS & FITTINGS

Our well-known product families include AMP, Simel, and Utilux supply connectors and fittings for low, medium, and high voltage overhead and underground networks. These products have been trusted for decades in complex markets such as substations, overhead lines, underground networks, grounding, original equipment manufacturers, and industrial applications.

INSULATION & PROTECTION

We provide vital insulation and protection services for power utility, power OEM, railway, and wind applications from 280 V up to 1200 kV that ensure a safe and reliable power supply. TE's Raychem Cable Accessories, Bowthorpe EMP Surge Arresters, and Axicom High Voltage Insulators - and TE's material expertise have earned worldwide recognition for long-term performance in harsh environments.

Low Voltage



Medium Voltage



High Voltage



Underground



Insulators/Surge Arresters



Wildlife & Asset Protection



High Voltage



Nuclear

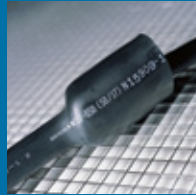

Low / Medium Voltage



Grounding



High Voltage Components



Hollow Core Insulators



Our Mission

Provide an integrated offering to deliver the best end-to-end cost advantage with the highest material science competence and drive flawless execution across all functions to gain strong customer intimacy.

A Legacy of Trusted Product Lines

ALR | AMP | Axicom | Bowthorpe EMP | Crompton Instruments | Raychem | Simel | Utilux



Our Culture of Innovation

We know your industry never stands still; and neither does TE. Our world-class materials science expertise helps us focus on what you need right now - and continue to create the next generation of technology to better serve you.

Material Innovations

Better, longer lasting products start with better materials. Our core materials science focus keeps us ahead of the changing needs of the electrical power industry.

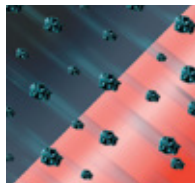

Non-tracking and UV stable materials



UHV composite materials



Moisture blocking

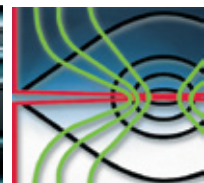

Reduced contact resistance



Surge suppression systems



Resin technology



PowerGel insulating material



Shear bolt technologies



High performance heat-shrinkable multi-layer materials

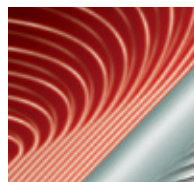

Electrical stress control

Table of Contents

1 Connectors and Terminals

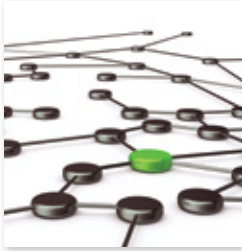

Shear Bolt Connectors.....	3
Compression Connectors	8
Insulation Piercing Connectors	11
Wedge Pressure Connectors	14
AMPACT Accessories.....	25
Miniwedge Connectors	33
Copper Grounding	38
Symmetrical Connector Selection Chart	48
AMPACT Selection Guide	51

2 Identification Solutions

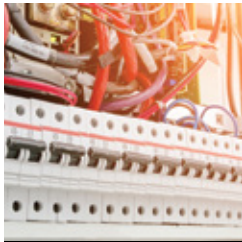

Heat Shrink Markers.....	100
Cable Markers	101
Labels	103
Portable Marker Kit	106
Accessories	107

3 Low Voltage Splices & Taps



Low Voltage In-line Splices.....	112
Low Voltage Taps.....	120
Network Protection	131

4 Medium Voltage Cable Accessories



In-Line Splice.....	134
Terminations	168
Motor Connection Kits & Stub Splices	187
Elbows & Accessories	189

5 High Voltage Cable Accessories & Insulators



Splices, Terminations & Accessories	214
Tools	224
High Voltage Insulators	226

6 Cable Repair & Rejacketing



GMRS Rejacketing Sleeve	230
MBSM Wraparound Jacket Repair	231
HVS-LR Repair Kits	232
CRSM Wraparound Sleeves (1000 V)	233
MRS Wraparound Flame Retardant Sleeve	234

7 Tubing & Molded Parts

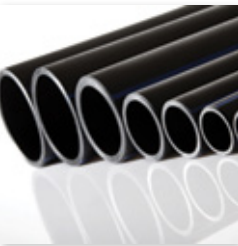

Heat Shrink Tubing	238
Molded Parts	243

8 Tapes & Sealants



Tapes	248
Sealants	252

9 Photo Controls



Thermal Photocontrol	256
Electronic Photocontrol	260
Time Controls	262
Lighting Accessories	265

10 Wildlife Asset Protection

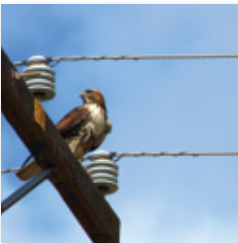

BUS Insulation & Wildlife Protection	270
Substations	276
Overhead	288
Contamination / Flashover Prevention	295

11 Accessories & Tools



Splicing Accessories	304
Termination Accessories	307
Conduit / Cable Sealing	309
Torches & Heat Guns	312
Tools	314

12 Applications



Applications by Cable Type	322
Low Voltage Tubing & Wraparound Sleeves	331
Splices	335
Terminations	340
Busbar / Wildlife Protection	345

Index	349
-------------	-----

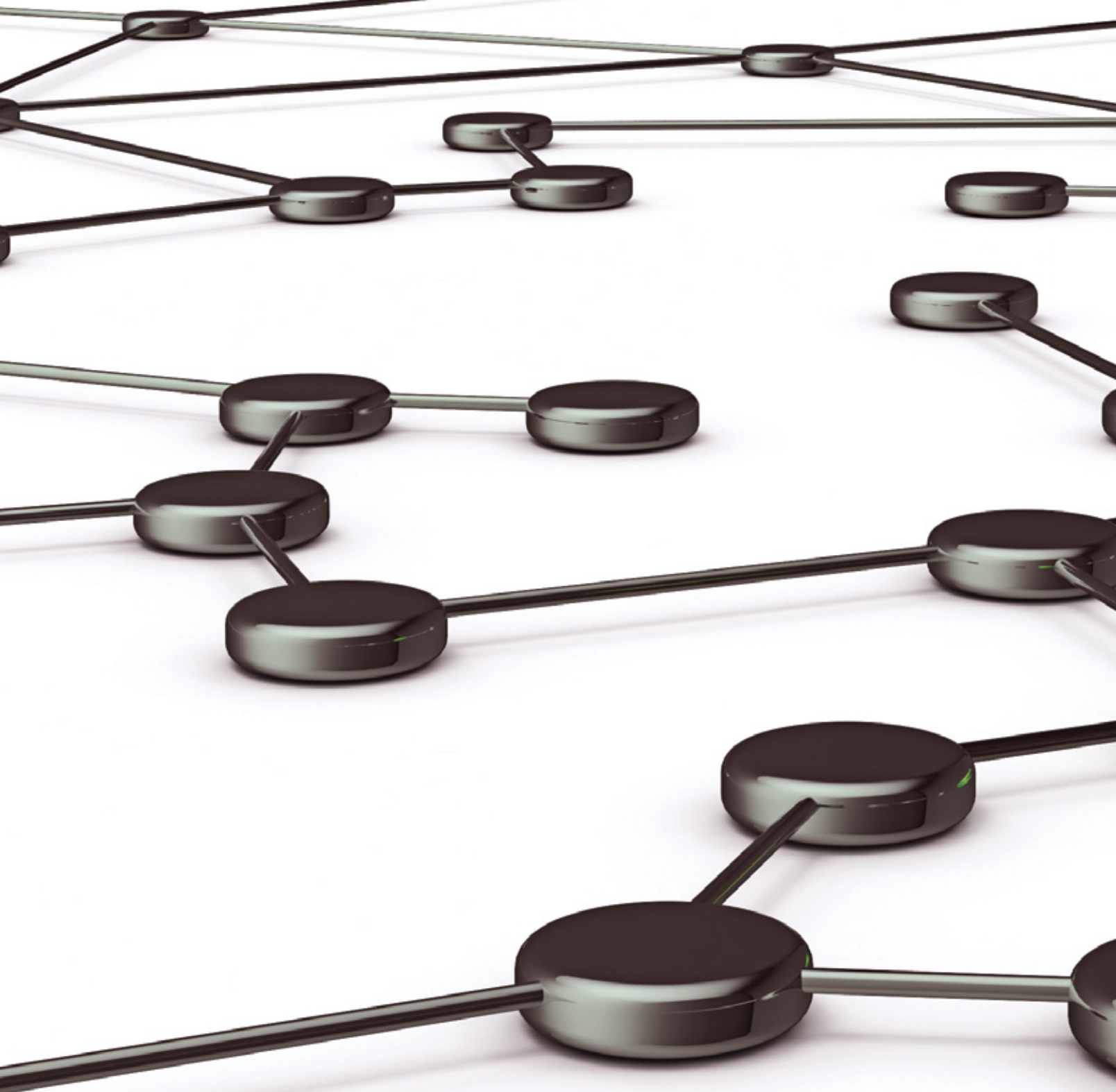



Chapter I

Connectors & Terminals

Shear Bolt Connectors	3
Compression Connectors	8
Insulation Piercing Connectors	11
Wedge Pressure Connectors	14
AMPACT Accessories	25
Miniwedge Connectors	33
Copper Grounding	38
Symmetrical Connector Selection Chart	48
AMPACT Selection Guide	51

Aluminum Shear Bolt Splice Connectors

1

FEATURES

- Shear Bolt connectors meet the electrical requirements (Class A) of ANSI C119.4 and exceed the mechanical requirements of a class 3 connector by a large margin of safety.
- The solid center stop (available on most sizes) inside the connector ensures proper conductor positioning and eliminates oil leakage when connecting oil impregnated conductors.
- Design made from seamless, high conductivity, high strength, tin-plated aluminum alloy for heavy-duty utility applications
- Compact and smooth body design
- Dual rated for aluminum and copper conductors

APPLICATIONS

- Accommodate a conductor range from #2 compact to 1000 kcmil concentric, stranded Class B.
- The primary application of aluminum Shear Bolt connectors is for underground splices up to 35 kV.
- Shear Bolt connectors are ideally suited for aluminum to aluminum, aluminum to copper and copper to copper applications making them the universal connector solution. Please refer to tests listed below.
- Shear Bolt connectors are designed to be compatible with TE's Raychem brand cable accessories and insulation products.

BENEFITS

- ♦ TE Connectivity's aluminum Shear Bolt connectors are range-taking mechanical connectors. Just six connectors will accommodate a wide range of aluminum and copper conductors from #2 AWG compact stranded to 1000 kcmil standard stranded class B.
- ♦ Provides long service life under normal operating conditions with reserve capacity for emergency loading conditions.
- ♦ The connector design incorporates shear head bolts, which ensures that the correct torque is applied to each bolt and the optimal contact force is generated to minimize connection resistance.

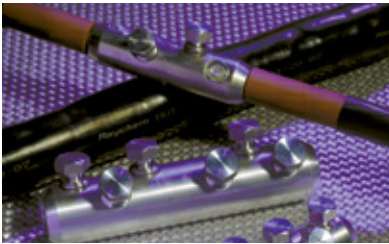

Ordering Information
Catalog Number T25446-000

Battery
Catalog Number J68898-000

PRODUCT SPECIFICATIONS

Wide application range	Six connectors needed to accommodate all cable sizes from #2 AWG compact strand to 1,000 kcmil concentric stranded in both aluminum and copper	Reduces inventory and prevents accidental use of the wrong connector
Hexagonal shear head bolts	Installs with simple ratchet-type socket wrench	Installs easily and quickly in confined areas
No crimp tooling or dies required	Installs easily using readily available tools	Ease of installation. Installation tool is no longer a source of failure. Reduces tool and die inventory, maintenance and cost
Torque-controlled shear head bolts	Sheared head gives positive indication of correct installation	Low contact resistance gives superior electrical performance
Centering inserts for small diameter conductors	Properly positions small conductors for proper connection	Minimizes voltage stresses at transition from connector body to cable installation
Knurled inner bore	Unique profile breaks through conductor oxides and grips conductor strands	Generates low contact resistance and increases pullout rating
Solid center stop	Eliminates oil leakage and insures proper conductor position	Accommodates transition applications from polymeric to oil impregnated conductors

PRODUCT SELECTION INFORMATION: DIMENSIONS IN INCHES (MM)

Catalog Number	Part Number	Conductor Range	O.D. Range	Length	Connector O.D.	Strip Length	Number of Bolts	Socket Size
Aluminum Shear Bolt Splice Connectors								
ASBS-2-3/0	CL8618-000	2 AWG compact stranded to 3/0 AWG standard stranded	.268-.470 (6.8-11.9)	2.5 (65)	.95 (24)	1 1/8 (28.5)	2	1/2 (13)
ASBS-2-350	694472-000	2 AWG compact stranded to 350 kcmil standard stranded	.268-.681 (6.8-17.3)	3.9 (100)	1.22 (31)	1 3/4 (44.4)	4	11/16 (17)
ASBS-3/0-500	CL8619-000	3/0 AWG compact stranded to 500 kcmil standard stranded	.423-.813 (10.7-20.6)	4.9 (125)	1.3 (34)	2 3/8 (60)	4	3/4 (19)
ASBS-3/0-500-S	CU2713-000	3/0 AWG compact stranded to 500 kcmil standard stranded	.423-.813 (10.7-20.6)	4.9 (125)	1.3 (34)	2 3/8 (60)	4	3/4 (19)
ASBS-350-750	CL7947-000	350 kcmil compact stranded to 750 kcmil standard stranded	.616-.998 (15.6-25.3)	6.7 (170)	1.67 (42.5)	3 1/8 (80)	6	7/8 (22)
ASBS-500-750	E89931-000	500 kcmil compact stranded to 750 kcmil standard stranded	.736-.998 (18.7-25.3)	6.0 (152)	1.52 (39)	2 7/8 (73)	6	3/4 (19)
ASBS-600-1000	C68131-000	600 kcmil compact stranded to 1000 kcmil standard stranded	.813-1.152 (20.6-29.2)	8.0 (203)	1.75 (44.4)	3 7/8 (98)	6	7/8 (22)

Catalog Number	Part Number	Conductor Range	O.D. Range	Length	Connector O.D.	Strip Length	Number of Bolts	Socket Size	Insert Used
Aluminum Shear Bolt Splice Connectors UL/CSA Listed									
ASBS-2-U	1974155-1	2 AWG compact to 2 AWG concentric	0.268-0.292 (6.81-7.42)	2.6 (65)	0.94 (24)	1 1/8 (28.5)	2	1/2 (13)	Yes**
ASBS-2-4/0-U	1974138-1	2 AWG compact to 4/0 AWG concentric	0.268-0.528 (6.81-13.41)	3.9 (100)	1.22 (31)	1 3/4 (44.4)	4	11/16 (17)	No
ASBS-2-4/0/250-350-U	2182352-1	Side #1: 2 AWG compact to 4/0 AWG concentric Side #2: 250 compact to 350 kcmil concentric	Side #1: 0.268-0.528 (6.81-13.41) Side #2: 0.520-0.681 (13.21-17.30)	3.9 (100)	1.22 (31)	1 3/4 (44.4)	4	11/16 (17)	No
ASBS-250-350-U	1974139-1	250 compact to 350 kcmil concentric	0.520-0.681 (13.21-17.30)	3.9 (100)	1.22 (31)	1 3/4 (44.4)	4	11/16 (17)	No
ASBR-250-350/350-500	2182769-1	Side #1: 250 compact to 350 kcmil concentric Side #2: 350 compact to 500 kcmil concentric	Side #1: 0.520-0.681 (13.21-17.30) Side #2: 0.616-0.813 (15.65-20.65)	5.4 (138)	1.3 (33) / 1.67 (42.5)	1.87 (47.5) / 3.2 (82.5)	5	11/16 (17) / 7/8 (22)	No
ASBR-250-350/600-750	2182770-1	Side #1: 250 compact to 350 kcmil concentric Side #2: 600 kcmil compact to 750 kcmil concentric	Side #1: 0.520-0.681 (13.21-17.30) Side #2: 0.813-0.998 (20.65-25.35)	5.4 (138)	1.3 (33) / 1.67 (42.5)	1.87 (47.5) / 3 1/8 (80)	5	11/16 (17) / 7/8 (22)	No
ASBS-350-500-U	1974144-1	350 compact to 500 kcmil concentric	0.616-0.813 (15.65-20.65)	6.7 (170)	1.67 (42.5)	3 1/8 (80)	6	7/8 (22)	Yes**
ASBR-350-500/ 600-750-U	1974146-1	Side #1: 350 kcmil compact to 500 kcmil concentric Side #2: 600 kcmil compact to 750 kcmil concentric	Side #1: 0.616-0.813 (15.65-20.65) Side #2: 0.813-0.998 (20.65-25.35)	6.7 (170)	1.67 (42.5)	3 1/8 (80)	6	7/8 (22)	Yes**
ASBR-350-500/1000	2182732-1	Side #1: 350 kcmil compact to 500 kcmil concentric Side #2: 1000 kcmil compact to 1000 kcmil concentric	Side #1: 0.616-0.813 (15.65-20.65) Side #2: 1.060-1.152 (26.92-29.26)	7.4 (189)	1.67 (42.5) / 1.75 (44.5)	3.25 (82.5) / 3.9 (99)	6	7/8 (22)	Yes**
ASBS-600-750-U	1974145-1	600 kcmil compact to 750 kcmil concentric	0.813-0.998 (20.65-25.35)	6.7 (170)	1.67 (42.5)	3 1/8 (80)	6	7/8 (22)	No
ASBR-600-750/1000	2182734-1	Side #1: 600 kcmil compact to 750 kcmil concentric Side #2: 1000 kcmil compact to 1000 kcmil concentric	Side #1: 0.813-0.998 (20.65-25.35) Side #2: 1.060-1.152 (26.92-29.26)	7.4 (189)	1.67 (42.5) / 1.75 (44.5)	3.25 (82.5) / 3.9 (99)	6	7/8 (22)	No
ASBS-1000-U	1974151-1	1000 kcmil compact to 1000 kcmil concentric	1.060-1.152 (26.92-29.26)	8.0 (203)	1.75 (44.5)	3 7/8 (98)	6	7/8 (22)	No

** DO NOT remove insert. Please contact your TE representative for conductor sizes or types not listed.

ADDITIONAL PRODUCT INFORMATION

P11: 408-8990, 408
Test Report: 502-47292 (1)



Listed by Underwriters Laboratories Inc., File No. E13288
Certified by Canadian Standards Association, File No. LR7189

Copper Shear Bolt Splice Connectors

1

FEATURES

- The connector is supplied with two copper inserts assembled into the connector body to center small conductor sizes. For larger sizes, inserts are not required and are easily removed with a standard screwdriver. Please see the installation table for details.
- An oxide-inhibiting joint compound is factory-applied in the barrel of the connector to provide low initial contact resistance, seal out air and moisture, prevent oxidation/corrosion, and maintain a reliable connection for the life of the installation.
- Copper Shear Bolt connectors have an impermeable oil block for connecting paper-insulated cables.

APPLICATIONS

- The connectors have been electrically tested to the class A requirements of ANSI C119.4 and mechanically rated at a pull out force of 1670 lbs for the #2 AWG to 250 kcmil version; 2300 lbs for the 2/0 AWG to 500 kcmil version; 3000 lbs for the 300 kcmil to 750 kcmil version; 3800 lbs for the 500 kcmil to 1000 kcmil version; 4500 lbs for the 1000 kcmil to 1250 kcmil version, and 6000 lbs for 2000 kcmil version. Engineering Test Reports are available upon request.

BENEFITS

- ♦ TE Connectivity's copper Shear Bolt connectors are range-taking, mechanical connectors that will accommodate a wide range of copper cables from #2 AWG compact stranded to 2000 kcmil compact stranded. The primary application is for underground splices up to 35 kV.

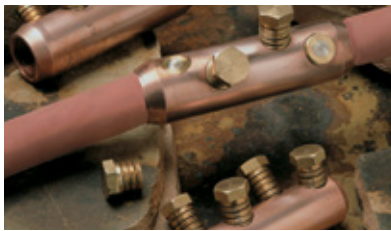

Ordering Information
Catalog Number T25446-000

Battery
Catalog Number J68898-000

INSTALLATION

Copper Shear Bolt connectors use four (six for the CSBS 500-1000) bronze alloy shear head bolts, two (or three) on each side of the center stop. A torque wrench is not required. The only tool required is a standard ratchet wrench with a hexagonal socket. * Refer to the following installation table.

Catalog Number	PII Number*	Socket Size	Test Reports	Application Guide
CSBS-2-250	408-10327	1/2 (13)	502-47407	Remove inserts for cable sizes equal to or greater than 4/0 AWG compressed
CSBS-2/0C-500C	408-8894	11/16 (17)	502-47265	Remove inserts for cable sizes equal to or greater than 300 kcmil compact.
CSBS-2/0-500-CPR	408-10327	11/16 (17)	502-47265	Remove inserts for cable sizes equal to or greater than 350 kcmil compressed.
CSBS-300C-750C	408-8863	3/4 (19)	502-47257 502-47260	Remove inserts for cable sizes equal to or greater than 500 kcmil compact.
CSBS-300-750	408-10327	3/4 (19)	502-47260	Remove inserts for cable sizes equal to or greater than 600 kcmil compressed.
CSBS-500-1000	408-10327	3/4 (19)	502-47386	Remove inserts for cable sizes equal to or greater than 750 kcmil stranded
CSBS-1000-1250	408-10317	3/4 (19)	502-47371 (I)	No insert
CSBS-2000	408-10327	3/4 (19)	502-47474 (I)	No insert

*Installation Instructions Reference Number

Please contact your TE representative for conductor sizes or types not listed in this catalog.

PRODUCT SELECTION INFORMATION: DIMENSIONS IN INCHES (MM)

Catalog Number	Part Number	Conductor Cable Range	O.D. Range	Length	Connector O.D.	Stop
CSBS-2-250	CU6629-000	#2 AWG compact to 250 kcmil conc stranded	.268-.575 (6.81-14.61)	3.2 (81)	1.05 (26.7)	Solid
CSBS-2/0C-500C	E20628-000	2/0 compact to 500 kcmil compact	.376-.736 (9.5-18.7)	4 (101)	1.2 (30.5)	Solid
CSBS-2/0-500-CPR	CU1218-000	2/0 compact to 500 kcmil compressed	.376-.79 (9.5-20)	4 (101)	1.3 (33)	Solid
CSBS-300C-750C	310084-000	300 kcmil compact to 750 kcmil compact	.570-.945 (14.5-24.0)	5 (127)	1.45 (36.8)	Solid
CSBS-300-750	ED2175-000	300 kcmil compact to 750 kcmil conc strand	.570-.99 (14.5-25.4)	5 (127)	1.5 (38.1)	Solid
CSBS-500-1000	ED2183-000	500 kcmil compact to 1000 kcmil conc stranded	.736 - 1.152 (1.87-2.93)	7 (178)	1.75 (44.5)	Solid
CSBS-1000-1250	ED2184-000	1000 kcmil compact to 1250 kcmil conc stranded	1.060 -1.289 (26.92-32.74)	7 (178)	1.9 (48)	Solid
CSBS-2000	2182603-1	2000 kcmil compact to 2000 kcmil conc stranded	1.535 - 1.632 (38.99-41.45)	8 (208)	2.3 (58.7)	Solid

Aluminum Shear Bolt Terminal Connectors

FEATURES

- To extend the range of a connector, an aluminum insert maybe assembled into the connector body, which centers the smaller conductor sizes in the barrel of the connector.
- Narrow pad terminals available for 1000 and 1250 kcmil conductor (ASBT-xxx-N)
- Heavy-duty design made of high strength, tin-plated aluminum alloy
- Compact and smooth body design
- Dual rated for aluminum and copper conductors
- The bore of the connector body has a unique grooved surface to enhance electrical contact and minimize resistance at the interface between the terminal and the conductor.
- The cable entry area is chamfered inside to provide easy cable insertion.
- The terminal is manufactured from high conductivity aluminum designed for heavy-duty utility applications.

APPLICATIONS

- The primary application of the ASBT is for power cable terminations, both underground and above ground at voltages up to 35 kV.
- ASBT is ideally suited for making aluminum or copper cable connections to flat bar or equipment pads equipped with 2-hole NEMA spacing

BENEFITS

- ♦ TE's Aluminum Shear Bolt Terminals are range-taking mechanical connectors that will accommodate a conductor range from #2 compact stranded to 1250 kcmil stranded, Class B.
- ♦ The connectors have been electrically tested to the class A requirements of ANSI C119.4 and exceed the mechanical requirements of a class 3 connector by a large margin of safety. The existing Aluminum Shear Bolt Splice (ASBS) connector Engineering Test Reports are applicable since the barrel end of the ASBT exactly replicates the design criteria of the ASBS.
- ♦ The connector design incorporates shear head bolts, which ensures that the correct torque is applied to each bolt and consequently the optimal contact force is generated to minimize connection resistance.
- ♦ The terminal design incorporates shear head bolts, which ensures that the correct torque is applied and consequently the optimal contact force is generated to minimize connection resistance.
- ♦ Provides long service life under normal operating conditions with reserve capacity for emergency loading conditions



Ordering Information

Catalog Number T25446-000

Battery

Catalog Number J68898-000

Wide Application Range	Five connectors needed to accommodate all cable sizes from #2 AWG compact strand to 1,250 kcmil concentric stranded in both aluminum and copper	Reduces inventory and prevents accidental use of the wrong connector
Hexagonal shear head bolts	Installs with simple ratchet-type socket wrench or TE's cordless impact wrench	Installs easily and quickly in confined areas
Impact wrench*	Installs easily and quickly in confined areas	Ease of installation. Installation tool is no longer a source of failure. Reduces tool and die inventory, maintenance and cost
No crimp tooling or dies required	Installs easily using readily available tools	Ease of installation. Installation tool is no longer a source of failure. Reduces tool and die inventory, maintenance and cost
2-hole NEMA pad	Connects conductor ranges to a flat surface (or between any conductor from the range to a flat pad)	Ideal for aluminum or copper cable connections to flat bar or equipment pads equipped with 2-hole NEMA spacing
Torque-controlled shear head bolts	Sheared head gives positive indication of correct installation	Low contact resistance gives superior electrical performance
Knurled inner bore on connector and insert	Unique profile breaks through conductor oxides and grips conductor strands	Generates low contact resistance and increases pullout rating

PRODUCT SELECTION INFORMATION: DIMENSIONS IN INCHES (MM)

Catalog Number	Part Number	Terminal Length	O.D.	Number of Bolts	Socket Size	Strip Length	Conductor Range	Conductor O.D. Range
Aluminum Shear Bolt Terminal Connectors								
ASBT-2-350	CM9694-000	5.9 (149)	1.22 (31)	2	11/16 (17)	1 3/4 (44)	2 AWG Compact to 350 kcmil Stranded	.268-.681 (6.8-17.3)
ASBT-350-750	CM9695-000	7.4 (188)	1.67 (42.5)	3	7/8 (22)	3 1/8 (79)	350 kcmil Compact to 750 kcmil Stranded	.616-.998 (15.7-25.3)
ASBT-600-1000	CM9696-000	7.7 (196)	1.75 (44.4)	3	7/8 (22)	3 3/4 (95)	600 kcmil Compact to 1000 kcmil Stranded	.813-1.152 (20.6-29.2)
ASBT-1000-N	2182430-1	7.7 (196)	1.75 (44.4)	3	7/8 (22)	3 3/4 (95)	1000 kcmil compact to 1000 kcmil Conc Stranded	1.060-1.152 (26.9-29.3)
ASBT-1250-2	CS9412-000	6.96 (176.7)	2.00 (50.8)	3	(13)	2 7/8 (75)	1250 kcmil compressed to 1250 kcmil Conc Stranded	1.190 - 1.250 (30.23 - 31.75)
ASBT-1250-2-N	CS9410-000	6.96 (176.7)	2.00 (50.8)	3	(13)	2 7/8 (75)	1250 kcmil compressed to 1250 kcmil Conc Stranded	1.190 - 1.250 (30.23 - 31.75)
ASBT-1250-4	CS9414-000	6.96 (176.7)	2.00 (50.8)	3	(13)	2 7/8 (75)	1250 kcmil compressed to 1250 kcmil Conc Stranded	1.190 - 1.250 (30.23 - 31.75)

Catalog Number	Part Number	Terminal Length	O.D.	Number of Bolts	Socket Size	Strip Length	Conductor Range	Conductor O.D. Range
Aluminum Shear Bolt Terminal Connectors UL/CSA Listed								
ASBT-2-4/0-U	1974141-1	5.9 (149)	1.22 (31)	2	11/16 (17)	1 3/4 (44)	2 AWG compact to 4/0 kcmil concentric	0.268-0.528 (6.80-13.40)
ASBT-250-350-U	1974142-1	5.9 (149)	1.22 (31)	2	11/16 (17)	1 3/4 (44)	250 kcmil compact to 350 kcmil concentric	0.520-0.681 (13.21-17.30)
ASBT-350-500-U	1974148-1	7.4 (188)	1.67 (42.5)	3	7/8 (22)	3 1/8 (79)	350 kcmil compact to 500 kcmil concentric	0.616-0.813 (15.65-20.65)
ASBT-600-750-U	1974149-1	7.4 (188)	1.67 (42.5)	3	7/8 (22)	3 1/8 (79)	600 kcmil compact to 750 kcmil concentric	0.813-0.998 (20.65-25.35)
ASBT-1000-U	1974153-1	7.7 (196)	1.75 (44.4)	3	7/8 (22)	3 3/4 (95)	1000 kcmil compact to 1000 kcmil concentric	1.060-1.152 (26.92-29.26)

An oxide-inhibiting joint compound is factory applied in the connector barrel to maintain a reliable connection for the life of the installation. The terminals have been successfully tested to UL 486A-486B and CSA C22.2 No. 65-03. Shear Bolt terminals are designed to be compatible with most TE's Raychem cable accessories and insulation products. Please consult your local TE sales representative for applicable products. For other applications, please consult the manufacturer's installation instructions for compatibility.



Listed by Underwriters Laboratories Inc.,
File No. E13288
Certified by Canadian Standards
Association, File No. LR7189

Please contact your TE representative for conductor sizes or types not listed in this datasheet.
Installation instructions:

ADDITIONAL PRODUCT INFORMATION

PII: 408-10264, 408-32169

Test Reports:
502-47292 (1)
502-47300 (1)
502-47340 (1)

Copper Compression Terminals

FEATURES

- Industry-standard color coding system simplifies die selection
- Chamfered connector end allows cable to be inserted easily
- One-piece, seamless construction from electrolytic tough pitch (ETP) copper for superior electrical performance and mechanical operation
- Closed barrel transition design for protection from moisture and contaminants
- Tin-plated for corrosion resistance and durability, and tempered for easy crimping

APPLICATIONS

- Copper compression terminals are ideally suited for secondary power distribution in buildings, power plants, electrical equipment, and industrial applications.
- Connectors can be used on applications up to 35 kV, and meet the requirements of UL486A and CSA C22.2 No. 65-95 when applied with approved die sets.

BENEFITS

- ♦ Copper compression terminals are available to accommodate a range of cable sizes from 6 AWG through 1,000 MCM and are designed for terminating concentric, compressed, and compact conductors. These terminals are offered in one-hole terminals from 6 AWG through 1,000 MCM with either a standard or long barrel. A two-hole NEMA terminal with a long barrel is also available for 4 AWG through 1,000 MCM.
- ♦ Compression crimping forms the terminal barrel and conductor into a strong, almost homogeneous unit, producing excellent conductivity, low temperature rise, and outstanding resistance to oxidation and corrosion.



PHYSICAL AND ELECTRICAL PROPERTIES

Material: ETP copper alloy C11000

Plating: Electro tin plate

Heat treating: Soft tempered

Voltage Rating: For applications up to 35 kV consult shielded cable manufacturers stress relief instructions.

PRODUCT SELECTION INFORMATION: DIMENSIONS IN INCHES

Catalog Number	Conductor Size	Stud Size	L	W	T	D	N	Color code
One Hole, Short Barrel								
1099898-1	6 STR.	1/4	1.5	0.45	0.08	0.56	0.27	blue
1099898-2	4 STR.	1/4	1.5	0.5	0.09	0.56	0.27	gray
1099898-3	3 STR.	5/16	1.6	0.57	0.09	0.7	0.34	white
1099898-4	2 STR.	5/16	1.6	0.61	0.11	0.7	0.34	brown
1099898-5	1 STR.	1/4	1.6	0.68	0.1	0.56	0.27	green
1099898-6	1/0 STR.	5/16	1.7	0.74	0.12	0.7	0.34	pink
1099898-7	1/0 STR.	1/2	2.1	0.88	0.09	1.08	0.53	pink
1099898-8	2/0 STR.	3/8	1.9	0.83	0.12	0.83	0.41	black
1099898-9	3/0 STR.	1/2	2.2	0.91	0.13	1.08	0.53	orange
1-1099898-0	4/0 STR.	1/2	2.2	1.02	0.14	1.08	0.53	purple
1-1099898-1	250 MCM	1/2	2.4	1.11	0.16	1.08	0.53	yellow
1-1099898-2	350 MCM	1/2	2.5	1.27	0.18	1.08	0.53	red
1-1099898-3	500 MCM	1/2	3.2	1.54	0.23	1.3	0.65	brown
1-1099898-4	750 MCM	5/8	4	1.88	0.27	1.94	0.88	black
1-1099898-5	1000 MCM	5/8	4.9	2.16	0.32	2.12	0.94	white

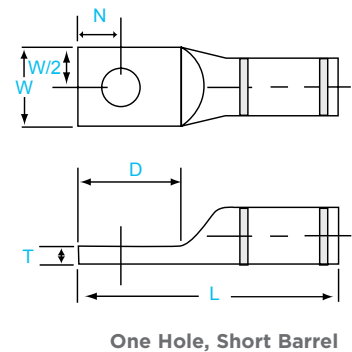

PRODUCT SELECTION INFORMATION: DIMENSIONS IN INCHES

Catalog Number	Conductor Size	Stud Size	L	W	T	D	N	Color code
One Hole, Long Barrel								
1099899-1	6 STR.	1/4	1.9	0.45	0.08	0.56	0.34	blue
1099899-2	4 STR.	1/4	1.9	0.5	0.09	0.56	0.38	gray
1099899-3	3 STR.	5/16	2.3	0.57	0.09	0.7	0.38	white
1099899-4	2 STR.	5/16	2.3	0.6	0.11	0.75	0.38	brown
1099899-5	1 STR.	5/16	2.4	0.68	0.1	0.75	0.27	green
1099899-6	1/0 STR.	5/16	2.4	0.74	0.12	0.75	0.27	pink
1099899-7	1/0 STR.	1/2	2.7	0.75	0.11	1.08	0.53	pink
1099899-8	2/0 STR.	3/8	2.7	0.82	0.12	0.88	0.44	black
1099899-9	3/0 STR.	1/2	2.9	0.91	0.13	1.08	0.53	orange
1-1099899-0	4/0 STR.	1/2	3.0	1.0	0.14	1.08	0.53	purple
1-1099899-1	250 MCM	1/2	3.2	1.09	0.16	1.12	0.56	yellow
1-1099899-2	300 MCM	1/2	3.6	1.19	0.16	1.12	0.56	white
1-1099899-3	350 MCM	1/2	3.7	1.28	0.18	1.12	0.56	red
1-1099899-4	400 MCM	5/8	4.2	1.38	0.19	1.5	0.75	blue
1-1099899-5	500 MCM	5/8	4.4	1.52	0.23	1.5	0.75	brown
1-1099899-6	500 MCM	1/2	4.2	1.54	0.23	1.3	0.65	brown
1-1099899-7	600 MCM	5/8	5.2	1.69	0.27	1.75	0.88	green
1-1099899-8	750 MCM	5/8	5.4	1.89	0.27	1.94	0.88	Black
1-1099899-9	1000 MCM	5/8	6.0	2.17	0.32	2.12	0.94	White
Two Hole NEMA, Long Barrel								
1099939-1	4 STR.	1/2	4.4	0.83	0.11	3.0	0.62	gray
1099939-2	3 STR.	1/2	4.4	0.83	0.11	3.0	0.62	white
1099939-3	2 STR.	1/2	4.5	0.82	0.11	3.0	0.62	brown
1099939-4	1 STR.	1/2	4.7	0.8	0.09	3.0	0.62	green
1099939-5	1/0 STR.	1/2	4.7	0.75	0.12	3.0	0.62	pink
1099939-6	2/0 STR.	1/2	4.8	0.82	0.12	3.0	0.62	black
1099939-7	3/0 STR.	1/2	4.8	0.9	0.12	3.0	0.62	orange
1099939-8	4/0 STR.	1/2	5.0	1.0	0.14	3.0	0.62	purple
1099939-9	250 MCM	1/2	5.0	1.09	0.16	3.0	0.62	yellow
1-1099939-0	300 MCM	1/2	5.4	1.18	0.16	3.0	0.62	white
1-1099939-1	350 MCM	1/2	5.4	1.27	0.18	3.0	0.62	red
1-1099939-2	500 MCM	1/2	5.7	1.53	0.23	3.0	0.62	brown
1-1099939-3	600 MCM	1/2	6.2	1.71	0.27	3.0	0.62	green
1-1099939-4	750 MCM	1/2	6.5	1.89	0.27	3.0	0.62	black
1-1099939-5	1000 MCM	1/2	6.8	2.16	0.33	3.0	0.62	white

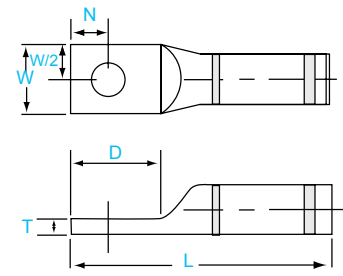

One Hole, Long Barrel

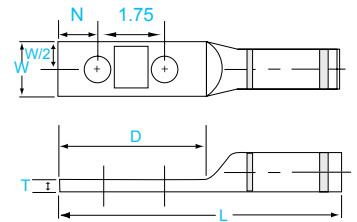

Two Hole NEMA, Long Barrel

ADDITIONAL INFORMATION:
PII NUMBER 408-8869

Copper Compression Splices

FEATURES

- Uses industry-standard tooling for simple installation
- Industry-standard color coding system simplifies die selection
- Chamfered connector end allows cable to be inserted easily
- One-piece, seamless construction from electrolytic tough pitch (ETP) copper for superior electrical performance and mechanical operation
- Tin-plated for corrosion resistance and durability, and tempered for easy crimping

APPLICATIONS

- Copper compression splices are ideally suited for secondary power distribution in buildings, power plants, electrical equipment, and industrial applications.
- Connectors can be used on applications up to 35 kV, and meet the requirements of UL486A and CSA C22.2 No. 65-95 when applied with approved die sets.

BENEFITS

- ♦ Copper compression splices are available to accommodate a range of cable sizes from 6 AWG through 1,000 MCM and are designed for splicing concentric, compressed and compact conductors. These splices are offered from 6 AWG through 1,000 MCM with either a standard or long barrel.
- ♦ Compression crimping forms the splice and conductor into a strong, almost homogeneous unit, producing excellent conductivity, low temperature rise, and outstanding resistance to oxidation and corrosion.

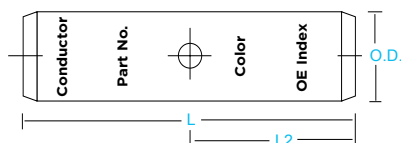

Standard Barrel Splice

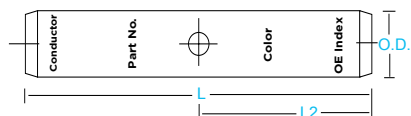

Long Barrel Splice



PHYSICAL AND ELECTRICAL PROPERTIES

Material: ETP copper alloy C11000

Plating: Electro tin plate

Heat treating: Soft tempered

Voltage rating: For applications up to 35 kV

Consult shielded cable manufacturers' stress relief instructions.

PRODUCT SELECTION INFORMATION: DIMENSIONS IN INCHES

Catalog Number	Conductor	L	L/2	D	Color Code
Standard Barrel Splice					
1443402-1	#6 STR	1.75	0.83	0.292	Blue
1443402-2	#4 STR	2.0	0.96	0.34	Gray
1443402-3	#3 STR	2.09	1.0	0.377	White
1443402-4	#2 STR	2.09	1.0	0.418	Brown
1443402-5	#1 STR	2.09	1.0	0.462	Green
1443402-6	1/0 STR	2.09	1.0	0.515	Pink
1443402-7	2/0 STR	2.18	1.05	0.583	Black
1443402-8	3/0 STR	2.32	1.11	0.618	Orange
1443402-9	4/0 STR	2.32	1.12	0.691	Purple
1-1443402-0	250 MCM	2.5	1.19	0.753	Yellow
1-1443402-1	300 MCM	2.5	1.19	0.815	White
1-1443402-2	350 MCM	2.62	1.25	0.844	Red
1-1443402-3	400 MCM	2.75	1.31	0.953	Blue
1-1443402-4	500 MCM	3.15	1.5	1.064	Brown
1-1443402-5	600 MCM	3.25	1.55	1.185	Green
1-1443402-6	750 MCM	3.75	1.8	1.302	Black
1-1443402-7	1000 MCM	4.26	2.06	1.504	White
Long Barrel Splice					
1443403-1	#6 STR	2.41	1.16	0.292	Blue
1443403-2	#4 STR	2.41	1.16	0.34	Gray
1443403-3	#3 STR	2.53	1.22	0.377	White
1443403-4	#2 STR	2.65	1.28	0.418	Brown
1443403-5	#1 STR	2.91	1.41	0.462	Green
1443403-6	1/0 STR	2.91	1.41	0.515	Pink
1443403-7	2/0 STR	3.15	1.53	0.583	Black
1443403-8	3/0 STR	3.15	1.53	0.618	Orange
1443403-9	4/0 STR	3.39	1.63	0.691	Purple
1-1443403-0	250 MCM	3.39	1.63	0.753	Yellow
1-1443403-1	300 MCM	4.13	2.0	0.815	White
1-1443403-2	350 MCM	4.13	2.0	0.844	Red
1-1443403-3	400 MCM	4.38	2.13	0.953	Blue
1-1443403-4	500 MCM	4.62	2.23	1.064	Brown
1-1443403-5	600 MCM	5.5	2.67	1.185	Green
1-1443403-6	750 MCM	5.88	2.86	1.302	Black
1-1443403-7	1000 MCM	6.12	2.96	1.504	White

Additional Information:
PII Number 408-8969

Insulation Connector Systems

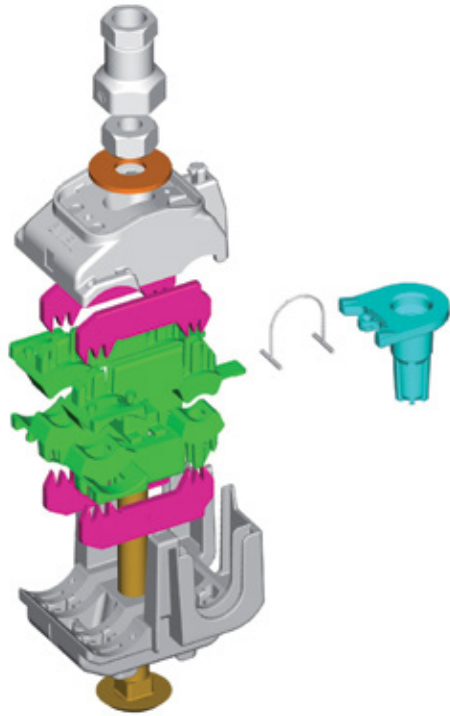

All our connectors are designed and tested to fit to majority types of cables made in accordance with the European Standard HD 626, regardless if cables are insulated with XLPE, PE or PVC. The products are tested according to national specifications such as NFC, VDE, BS, ESI and where possible in accordance to CENELEC EN 50483-4.

These standards include tests to verify reliable operation even in the harshest environments:

- Designed for Installation from $-20\text{ }^{\circ}\text{C}$ up to $+50\text{ }^{\circ}\text{C}$,
- Operation experience with temperatures ranging from $-60\text{ }^{\circ}\text{C}$ up to $+60\text{ }^{\circ}\text{C}$,
- No limitation of mechanical loads for main and branch conductors,
- Shear head forces are adapted to the required contact forces for each application (main, service, lightning),
- Voltage withstand to 6 kV in a 30 cm waterbath,
- No change in contact resistance and temperature after overloads and load cycling,
- Voltage withstand to 6 kV after heavy weathering exposure (UV-light, humidity and temperature cycling),
- Corrosion resistance of metal parts proven in salt fog chamber and wet SO_2 gas chamber.

INSTALLATION PROCESS ENGINEERED FOR LONG-TERM RELIABILITY

Before installation

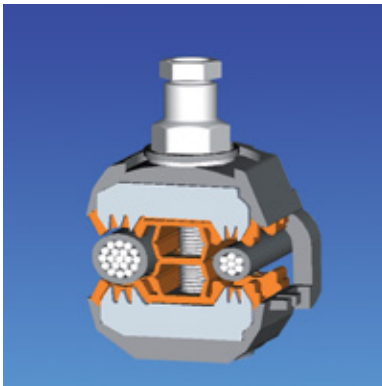

Connector easily positioned over cables, no loose parts can fall to ground. The correct position of the branch conductor can be felt inside the end cap.

During installation



Contact blades pierce the insulation and reliably contact the conductors. The tightening screw is insulated from the contact blades thus providing maximum safety for the installer even during live line installations.

After shear head breaking



The shear head ensures that conductors are not damaged by too strong forces. The long neck prevents the head from hasty shearing off by naturally applied cantilever loads on the tightening tool. The seals firmly conform to the insulation to prevent any moisture ingress.

Insulation Connector Systems

FEATURES

- Quick, reliable, and safe connections on energized conductors (not under load)
- Potential free tightening bolts allow safe installations on life lines
- Exceeds requirements according to NFC 33020 and EN 50483-4
- Components not losable, end cap attached to body.
- Wide conductor range, bare and insulated cables
- Tin-plated copper alloy contacts pierce insulation sheath
- Single bolt application with ring washers provide residual contact force
- Torque-control nut for precise pressure on conductor and insulation
- Operating temperature from -40°C to +60°C
- Insulation material made of weather and UV resistant glass fibre reinforced polymer
- Contact plates made of aluminium or copper, bolt made of steel with Geomet (Chromium free) protection

APPLICATIONS

- The waterproof insulation piercing connectors are suitable for majority types of LV ABC conductors as well as connections to service and lighting cable cores.
- When tightening the bolts, the teeth of the contact plates penetrate the insulation and establish a perfect contact. The bolts are tightened until the heads shear off.
- Stripping of insulation is avoided.
- Suitable for aluminum and copper conductors

BENEFITS

- ♦ Provides electrical connection for aluminum and copper stranded conductors without stripping and removing insulation from the conductors.
- ♦ Establishes electrical contact, protects, and seals the contact interface, and electrically insulates the connection, eliminating the need for weather-proofing and re-insulating.



INSULATION CONNECTOR SYSTEM

SIMULTANEOUS PIERCING OF MAIN AND BRANCH CONDUCTOR

Catalog Number	Part Number	Application range AWG (mm ²)	
		Main	Tap
For Main to Service Connections			
EP35-13	E84478-000	#14 - #2 (2.5 - 35)	#16 - #10 (1.5 - 6)
EP95-13	D12469-000	#6 - 4/0 (16 - 95)	#16 - #8 (1.5 - 10)
KZEP-4/0	908276-000	#6 - 4/0 (16 - 95)	#16 - #10 (1.5 - 6)
P2X95 Mk2	CP2398-000	#6 - 4/0 (16 - 95)	#12 - #2 (4 - 35)
EP120-13	F45314-000	#6 - 250 (16 - 120)	#16 - #10 (1.5 - 6)
P2X 150	C41222-000	1/0 - 300 (50 - 150)	#10 - #2 (6 - 35)
BR 240-35	411168-000	1/0 - 500 (50 - 240)	#10 - #2 (6 - 35)
P2G-300	708720-000	1/0 - 600 (50 - 300)	#10 - #2 (6 - 35)
For Main to Main Connectors			
P3X 95	C44126-000	#4 - 4/0 (25 - 95)	#4 - 4/0 (25 - 95)
P3X 4/0	F33734-000	#4 - 4/0 (25 - 95)	#4 - 4/0 (25 - 95)
P4X 120D	C63836-000	#4 - 250 (25 - 120)	#4 - 250 (25 - 120)
P4X 150D	F24596-000	1/0 - 300 (50 - 150)	1/0 - 300 (50 - 150)
DR 240X1	402310-001	4/0 - 500 (95 - 240)	4/0 - 500 (95 - 240)

INDEPENDENT CONNECTION OF MAIN (PIERCING) AND BRANCH CONDUCTOR (STRIPPABLE)

Catalog Number	Part Number	Application range AWG (mm ²)	
		Main	Tap
Main to 2 Service Connections (Bp-piercing tap side, B-Strippable tap side)			
KZ 2 - 150 2B	296510-000	#4 - 300 (25 - 150)	2 x #10 - #2 (6 - 35)
KZ 2 - 150 2Bp	036126-000	#4 - 300 (25 - 150)	2 x #10 - #2 (6 - 35)
Main to Main Connections (Strippable Tap Side)			
P31F	CX4230-000	#2 - 300 (25 - 150)	#2 - 2/0 (35 - 70)

SIMULTANEOUS CONNECTION OF MAIN (BARE) AND BRANCH (INSULATED) CONDUCTOR

Catalog Number	Part Number	Application range AWG (mm ²)	
		Main	Tap
Main to 2 Service Connections (Bp-piercing tap side, B-Strippable tap side)			
EPB95-13	2832033-1	#6 - 4/0 (16 - 95)	#16 - #8 (1.5 - 10)
P2X 95 Mk2*	CP2398-000	#10 - 4/0 (8 - 95)	#12 - #2 (4 - 35)
P2B100 U Mk2	2107864-1	#10 - 250 (8 - 120)	#4 - #4/0 (25 - 95)

* Connector of type P2X can only be used for connections between aluminium conductors.

Wedge Pressure Technology

FEATURES

- Developed to overcome the physical and electrical limitations of traditional compression or bolted connectors.
- Designed around an engineering principle that TE calls “Wedge Pressure Technology”.

APPLICATIONS

- Maintains a constant force within the connection for the life of the connector, while compensating for thermal expansion or “creep”

BENEFITS

- ♦ Maximizes contact between the connector and conductor surfaces
- ♦ Overcomes the problems associated with oxidation of metallic surfaces
- ♦ Provides a simple, fool proof method for connector installation

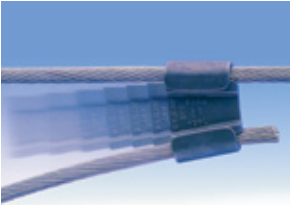

AMPACT Aluminum Tap System

FEATURES

- Installing taps takes a fraction of the time needed for conventional crimp-type connectors
- A locking tab prevents wedge from loosening once it has been driven into position. Every connection may be visually inspected by checking wedge movement and locking tab.
- Taps may be used to connect multiple conductor combinations
- No damage to the conductors when installing or removing tap
- Lightweight, power-actuated tools require minimum operator effort
- “C” and wedge are factory coated with an inhibitor containing abrasive particles to help clean the contact surfaces during installation

APPLICATIONS

- Used to connect solid and stranded aluminum, aluminum alloy and stranded aluminum composite conductors including AAC, AAAC, ACSR, ACAR, AW, ACSR/AW, and ACSS.
- They may also be used in non-corrosive environments to connect copper conductors.

BENEFITS

- ♦ The proven AMPACT tap “C-spring” and wedge design provides a stored energy system that prevents connector degradation and achieves significantly lower resistance than any competitive product over the “in service” life of the connector.
- ♦ As thermal cycling causes the conductors to expand and contract, the AMPACT tap spring member flexes and maintains constant contact pressure.
- ♦ Individual tap packages are imprinted with applicable conductor combinations. Packages and labels are color coded to easily match taps with proper tool and cartridge combination



Listed File No. E13288
RUS: ANSI C119.4
Class AA - Electrical
Class 1 - Mechanical

Conductor Standard Sizes	Size Tap Conductor Applicable
1192.5 kcmil	1192.5 thru 6
1033.5	1033.5 thru 6
795	795 thru 6
556.5	556.5 thru 6
477	477 thru 6
397.5	397.5 thru 6
350	350 thru 6
336.4	336.4 thru 6
266.8	266.8 thru 6
4/0 AWG	4/0 thru 6
3/0	3/0 thru 6
2/0	2/0 thru 6
1/0	1/0 thru 14
2	2 thru 14
4	4 thru 14
6	6 thru 14

AMPACT SELECTION GUIDE

Catalog Number	Wire Combinations
Type II Street Light Taps (White Cartridge P/N 69338-5 separately)	
83653-1	1/0-10-12-14
83653-2	2-10-12-14
83653-5	4-10-12-14
83653-3	6-10-12-14
83653-4	8-10-12-14
Type II Taps (White Cartridge P/N 69338-5 separately)	
602283	1/0-2
602283-1	2-2; 1/0-4
602283-2	2-4; 1/0-6
602283-3	4-4; 2-6
602283-4	6-6; 4-6
602283-5	8-8
602283-6	1/0-8
602283-7	2-8
602283-8	6-8; 4-8
Medium Taps (Blue Cartridge P/N 69338-1 separately)	
600403	1/0-1/0; 2/0-2; 1/0-2
600411	2/0-2/0; 3/0-1/0; 4/0-2
600446	3/0-6; 2/0-6
600447	2/0-4; 3/0-4
600448	2/0-1/0; 3/0-2
600455	4/0-4
600456	4/0-4
600458	3/0-2/0; 4/0-1/0
600459	3/0-3/0; 4/0-2/0
600465	4/0-3/0
600466	4/0-4/0
266.8 kcmil Taps (Blue Cartridge P/N 69338-1 separately)	
602046-1	266.86
602046-2	266.8-4
602046-3	266.8-2
602046-4	266.8-1/0
602046-5	266.8-2/0
602046-6	266.8-3/0
602046-7	266.8-4/0
602046-9	266.8-266.8
350 kcmil Taps (Blue Cartridge P/N 69338-1 separately)	
602380	350-6
602380-1	350-4
602380-2	350-2
602380-3	350-1/0
602380-4	350-2/0
602380-5	350-3/0
602380-6	350-4/0
602380-7	350-350
336.4-477-556.5 kcmil Taps (Yellow Cartridge P/N 69338-4 separately)	
602014	336.4-6
602013	336.4-4
602000	336.4-2
602001	336.4-1/0
602002	336.4-2/0
602003	336.4-3/0
602004	336.4-4/0
602006	336.4-266.8
602007	336.4-336.4
602031-8	477.0-2, 3
602031-9	477.0-4, 5
1-602031-0	477.0-6
1-602031-2	556.5-477.0; 556.5
1-602031-3	477.0-477.0; 556.5-336.4
1-602031-4	477.0-336.4; 556.5-266.8
1-602031-5	477.0-266.8; 556.5-3/0; 4/0
1-602031-6	477.0-4/0; 556.5-2/0
1-602031-7	477.0-3/0; 556.5-1/0
1-602031-8	477.0-2/0; 556.5-1
1-602031-9	477.0-1/0; 556.5-2
2-602031-0	556.5-2; 3
2-602031-1	556.5-4; 5
2-602031-2	556.5-6

Catalog Number	Wire Combinations
795 kcmil Taps (Yellow Cartridge P/N 69338-4 separately)	
602121	795-795
602121-1	795-715
602121-2	795-636
602121-3	795-556.5
602121-4	795-477
602121-5	795-397.5
602121-6	795-336.4
602121-7	795-266.8
602121-8	795-4/0
602121-9	795-3/0
1-602121-0	795-2/0
1-602121-1	795-1/0
1-602121-2	795-2
1-602121-3	795-4
1-602121-4	795-6
1033.5 kcmil Taps (Yellow Cartridge P/N 69338-4 separately)	
602180	1033.5-1033.5
602180-1	1033.5-954.0
602180-2	1033.5-795.0
602180-3	1033.5-715.5
602180-4	1033.5-636.0
602180-5	1033.5-556.5
602180-6	1033.5-477.0
602180-7	1033.5-397.5
602180-8	1033.5-336.4
602180-9	1033.5-266.8
1-602180-0	1033.5-4/0
1-602180-1	1033.5-3/0
1-602180-2	1033.5-2/0
1-602180-3	1033.5-1/0
1-602180-4	1033.5-2
1-602180-5	1033.5-4
1-602180-6	1033.5-6
1192.5 kcmil Taps (Yellow Cartridge P/N 69338-4 separately)	
602300	1192.5-1192.5
602300-1	1192.5-1033.5
602300-2	1192.5-954.0
602300-3	1192.5-795.0
602300-4	1192.5-715.5
602300-5	1192.5-636.0
602300-6	1192.5-556.5
602300-7	1192.5-477.0
602300-8	1192.5-397.5
602300-9	1192.5-336.4
1-602300-0	1192.5-266.8
1-602300-1	1192.5-4/0
1-602300-2	1192.5-3/0
1-602300-3	1192.5-2/0
1-602300-4	1192.5-1/0
1-602300-5	1192.5-2
1-602300-6	1192.5-4
1-602300-7	1192.5-6

Note: For specific wire sizes refer to the AMPACT Tap Selection Guide.

AMPACT DIAMETER LIMITS SELECTION GUIDE: DIMENSIONS IN INCHES (MM)

Catalog Number	Sum of Diameters		(Large Groove) Through Wire Diameter		(Small Groove) Tap Wire Diameter	
	max	min	max	min	max	min
Type II Taps (White Coded)						
602283	.724 (18.39)	.583 (14.81)	.398 (10.11)	.257 (6.53)	.398 (10.11)	.257 (6.53)
602283-1	.656 (16.66)	.515 (13.08)	.398 (10.11)	.257 (6.53)	.330 (8.38)	.204 (5.18)
602283-2	.602 (15.29)	.464 (11.79)	.398 (10.11)	.257 (6.53)	.258 (6.55)	.162 (4.11)
602283-3	.530 (13.46)	.410 (10.41)	.330 (8.38)	.204 (5.18)	.258 (6.55)	.162 (4.11)
602283-4	.456 (11.58)	.331 (8.41)	.258 (6.55)	.162 (4.11)	.230 (5.84)	.162 (4.11)
602283-5	.324 (8.23)	.256 (6.50)	.162 (4.11)	.128 (3.25)	.162 (4.11)	.128 (3.25)
602283-6	.560 (14.22)	.452 (11.48)	.398 (10.11)	.257 (6.53)	.162 (4.11)	.128 (3.25)
602283-7	.488 (12.40)	.387 (9.83)	.398 (10.11)	.257 (6.53)	.162 (4.11)	.128 (3.25)
602283-8	.416 (10.57)	.297 (7.54)	.258 (6.55)	.162 (4.11)	.162 (4.11)	.128 (3.25)
Medium Wire Range Taps (Blue Coded)						
600403	.796 (20.22)	.621 (15.77)	.500 (12.70)	.324 (8.23)	.464 (11.79)	.257 (6.53)
600411	.901 (22.89)	.736 (18.69)	.572 (14.53)	.364 (9.25)	.464 (11.79)	.257 (6.53)
600446	.707 (17.96)	.526 (13.36)	.572 (14.53)	.364 (9.25)	.204 (5.18)	.162 (4.11)
600447	.761 (19.33)	.570 (14.48)	.572 (14.53)	.364 (9.25)	.258 (6.55)	.204 (5.18)
600448	.846 (21.49)	.690 (17.53)	.572 (14.53)	.364 (9.25)	.398 (10.11)	.257 (6.53)
600455	.769 (19.53)	.622 (15.80)	.572 (14.53)	.364 (9.25)	.204 (5.18)	.162 (4.11)
600456	.823 (20.90)	.664 (16.87)	.572 (14.53)	.364 (9.25)	.258 (6.55)	.204 (5.18)
600458	.963 (24.46)	.804 (20.42)	.572 (14.53)	.364 (9.25)	.464 (11.79)	.257 (6.53)
600459	1.013 (25.73)	.858 (21.79)	.572 (14.53)	.364 (9.25)	.572 (14.53)	.364 (9.25)
600465	1.068 (27.13)	.938 (23.83)	.572 (14.53)	.364 (9.25)	.572 (14.53)	.364 (9.25)
600466	1.130 (28.70)	.956 (24.28)	.572 (14.53)	.364 (9.25)	.572 (14.53)	.364 (9.25)
226.8 kcmil Range Taps (Blue Coded)						
602046-1	.846 (21.49)	.699 (17.75)	.650 (16.51)	.525 (13.34)	.204 (5.18)	.162 (4.11)
602046-2	.900 (22.86)	.755 (19.18)	.650 (16.51)	.525 (13.34)	.258 (6.55)	.204 (5.18)
602046-3	.972 (24.69)	.818 (20.78)	.650 (16.51)	.525 (13.34)	.330 (8.38)	.257 (6.53)
602046-4	1.052 (26.72)	.897 (22.78)	.650 (16.51)	.525 (13.34)	.500 (12.70)	.324 (8.23)
602046-5	1.104 (28.04)	.963 (24.46)	.650 (16.51)	.525 (13.34)	.562 (14.27)	.364 (9.25)
602046-6	1.159 (29.44)	1.015 (25.78)	.650 (16.51)	.525 (13.34)	.562 (14.27)	.409 (10.39)
602046-7	1.217 (30.91)	1.080 (27.43)	.650 (16.51)	.525 (13.34)	.575 (14.61)	.460 (11.68)
602046-9	1.284 (32.61)	1.149 (29.18)	.650 (16.51)	.525 (13.34)	.650 (16.51)	.525 (13.34)
350 kcmil Range Taps (Blue Coded)						
602380	.885 (22.48)	.738 (18.75)	.684 (17.37)	.600 (15.24)	.204 (5.18)	.162 (4.11)
602380-1	.939 (23.85)	.794 (20.17)	.684 (17.37)	.600 (15.24)	.258 (6.55)	.204 (5.18)
602380-2	1.011 (25.68)	.857 (21.77)	.684 (17.37)	.600 (15.24)	.333 (8.46)	.257 (6.53)
602380-3	1.091 (27.71)	.936 (23.77)	.684 (17.37)	.600 (15.24)	.500 (12.70)	.324 (8.23)
602380-4	1.143 (29.03)	1.002 (25.45)	.684 (17.37)	.600 (15.24)	.562 (14.27)	.364 (9.25)
602380-5	1.198 (30.43)	1.054 (26.77)	.684 (17.37)	.600 (15.24)	.562 (14.27)	.409 (10.39)
602380-6	1.284 (32.61)	1.119 (28.42)	.684 (17.37)	.600 (15.24)	.600 (15.24)	.460 (11.68)
602380-7	1.368 (34.75)	1.188 (30.18)	.684 (17.37)	.600 (15.24)	.684 (17.37)	.600 (15.24)
336.4 kcmil Range Taps (Yellow Coded)						
602000	1.069 (27.15)	.860 (21.84)	.750 (19.05)	.524 (13.31)	.355 (9.02)	.257 (6.53)
602001	1.141 (28.98)	.927 (23.55)	.750 (19.05)	.524 (13.31)	.557 (14.15)	.324 (8.23)
602002	1.190 (30.23)	.967 (24.56)	.750 (19.05)	.524 (13.31)	.619 (15.72)	.364 (9.25)
602003	1.245 (31.62)	1.012 (25.70)	.750 (19.05)	.524 (13.31)	.619 (15.72)	.409 (10.39)
602004	1.306 (33.17)	1.063 (27.00)	.750 (19.05)	.524 (13.31)	.630 (16.00)	.460 (11.68)
602006	1.370 (34.08)	1.140 (28.96)	.750 (19.05)	.524 (13.31)	.750 (19.05)	.524 (13.31)
602007	1.456 (36.98)	1.206 (30.63)	.750 (19.05)	.524 (13.31)	.750 (19.05)	.524 (13.31)
602013	.999 (25.37)	.807 (20.50)	.750 (19.05)	.524 (13.31)	.258 (6.55)	.204 (5.18)
602014	.932 (23.67)	.765 (19.43)	.750 (19.05)	.524 (13.31)	.204 (5.18)	.162 (4.11)
477.0 kcmil Range Taps (Yellow Coded)						
602031-8	1.185 (30.10)	.995 (25.27)	.893 (22.68)	.666 (16.92)	.326 (8.28)	.257 (6.53)
602031-9	1.118 (28.40)	.942 (23.93)	.893 (22.68)	.666 (16.92)	.258 (6.55)	.204 (5.18)
1-602031-0	1.056 (26.82)	.900 (22.86)	.893 (22.68)	.666 (16.92)	.199 (5.05)	.162 (4.11)

NOTE: Wire must fit in small Diameter range and Large diameter range. Sum of both wires must fit with in the Min and Max of sum of diameters.

AMPACT DIAMETER LIMITS SELECTION GUIDE: DIMENSIONS IN INCHES (MM)

Catalog Number	Sum of Diameters		(Large Groove) Through Wire Diameter		(Small Groove) Tap Wire Diameter	
	max	min	max	min	max	min
477.0/556.5 kcmil Range Taps (Yellow Coded)						
1-602031-2	1.854 (47.09)	1.692 (42.98)	.950 (24.13)	.722 (18.34)	.950 (24.13)	.722 (18.34)
1-602031-3	1.741 (44.22)	1.524 (38.71)	.940 (23.88)	.666 (16.92)	.940 (23.88)	.666 (16.92)
1-602031-4	1.587 (40.31)	1.366 (34.70)	.940 (23.88)	.666 (16.92)	.750 (19.05)	.573 (14.55)
1-602031-5	1.500 (38.10)	1.297 (32.94)	.940 (23.88)	.666 (16.92)	.750 (19.05)	.481 (12.22)
1-602031-6	1.421 (36.09)	1.216 (30.89)	.940 (23.88)	.666 (16.92)	.650 (16.51)	.436 (11.07)
1-602031-7	1.360 (34.54)	1.147 (29.13)	.940 (23.88)	.666 (16.92)	.562 (14.27)	.382 (9.70)
1-602031-8	1.305 (33.15)	1.102 (27.99)	.940 (23.88)	.666 (16.92)	.562 (14.27)	.346 (8.79)
1-602031-9	1.270 (32.26)	1.062 (26.97)	.940 (23.88)	.666 (16.92)	.450 (11.43)	.324 (8.23)
2-602031-0	1.247 (31.67)	1.115 (28.32)	.940 (23.88)	.666 (16.92)	.326 (8.28)	.257 (6.53)
2-602031-1	1.181 (30.00)	1.062 (26.97)	.940 (23.88)	.666 (16.92)	.258 (6.55)	.204 (5.18)
2-602031-2	1.126 (28.60)	1.020 (25.91)	.940 (23.88)	.666 (16.92)	.199 (5.05)	.162 (4.11)
795.0 kcmil Range Taps (Yellow Coded)						
602121	2.216 (56.29)	2.072 (52.63)	1.156 (29.36)	.858 (21.79)	1.158 (29.41)	.858 (21.79)
602121-1	2.159 (54.84)	2.002 (50.85)	1.156 (29.36)	.858 (21.79)	1.156 (29.36)	.858 (21.79)
602121-2	2.098 (53.29)	1.946 (49.43)	1.156 (29.36)	.858 (21.79)	1.156 (29.36)	.858 (21.79)
602121-3	2.035 (51.69)	1.891 (48.03)	1.156 (29.36)	.858 (21.79)	1.156 (29.36)	.858 (21.79)
602121-4	1.966 (49.94)	1.822 (46.28)	1.156 (29.36)	.858 (21.79)	.900 (22.86)	.700 (17.78)
602121-5	1.891 (48.03)	1.747 (44.37)	1.156 (29.36)	.858 (21.79)	.900 (22.86)	.700 (17.78)
602121-6	1.829 (46.46)	1.685 (42.80)	1.156 (29.36)	.858 (21.79)	.750 (19.05)	.525 (13.34)
602121-7	1.750 (44.45)	1.606 (40.79)	1.156 (29.36)	.858 (21.79)	.722 (18.34)	.525 (13.34)
602121-8	1.670 (42.42)	1.526 (38.76)	1.156 (29.36)	.858 (21.79)	.722 (18.34)	.364 (9.25)
602121-9	1.610 (40.89)	1.466 (37.24)	1.156 (29.36)	.858 (21.79)	.608 (15.44)	.364 (9.25)
1-602121-0	1.555 (39.50)	1.411 (35.84)	1.156 (29.36)	.858 (21.79)	.608 (15.44)	.364 (9.25)
1-602121-1	1.506 (38.25)	1.362 (34.59)	1.156 (29.36)	.858 (21.79)	.436 (11.07)	.324 (8.23)
1-602121-2	1.434 (36.42)	1.290 (32.77)	1.156 (29.36)	.858 (21.79)	.398 (10.11)	.257 (6.53)
1-602121-3	1.365 (34.67)	1.221 (31.01)	1.156 (29.36)	.858 (21.79)	.312 (7.92)	.204 (5.18)
1-602121-4	1.306 (33.17)	1.162 (29.51)	1.156 (29.36)	.858 (21.79)	.250 (6.35)	.162 (4.11)
1033.5 kcmil Range Taps (Yellow Coded)						
602180	2.496 (63.40)	2.332 (59.23)	1.250 (31.75)	.856 (21.74)	1.250 (31.75)	.856 (21.74)
602180-1	2.411 (61.24)	2.251 (57.18)	1.250 (31.75)	.856 (21.74)	1.250 (31.75)	.856 (21.74)
602180-2	2.354 (59.79)	2.194 (55.73)	1.250 (31.75)	.856 (21.74)	1.250 (31.75)	.856 (21.74)
602180-3	2.297 (58.34)	2.137 (54.28)	1.250 (31.75)	.856 (21.74)	1.250 (31.75)	.856 (21.74)
602180-4	2.236 (56.79)	2.076 (52.73)	1.250 (31.75)	.856 (21.74)	1.250 (31.75)	.856 (21.74)
602180-5	2.173 (55.19)	2.013 (51.13)	1.250 (31.75)	.856 (21.74)	1.250 (31.75)	.856 (21.74)
602180-6	2.104 (53.44)	1.944 (49.38)	1.250 (31.75)	.856 (21.74)	.900 (22.86)	.700 (17.78)
602180-7	2.029 (51.54)	1.869 (47.47)	1.250 (31.75)	.856 (21.74)	.900 (22.86)	.700 (17.78)
602180-8	1.967 (49.96)	1.807 (45.90)	1.250 (31.75)	.856 (21.74)	.750 (19.05)	.525 (13.34)
602180-9	1.888 (47.96)	1.728 (43.89)	1.250 (31.75)	.856 (21.74)	.722 (18.34)	.525 (13.34)
1-602180-0	1.808 (45.92)	1.648 (41.86)	1.250 (31.75)	.856 (21.74)	.608 (15.44)	.364 (9.25)
1-602180-1	1.748 (44.40)	1.588 (40.34)	1.250 (31.75)	.856 (21.74)	.608 (15.44)	.364 (9.25)
1-602180-2	1.693 (43.00)	1.533 (38.94)	1.250 (31.75)	.856 (21.74)	.608 (15.44)	.364 (9.25)
1-602180-3	1.644 (41.76)	1.484 (37.69)	1.250 (31.75)	.856 (21.74)	.398 (10.11)	.324 (8.23)

NOTE: Wire must fit in small Diameter range and Large diameter range. Sum of both wires must fit with in the Min and Max of sum of diameters.

AMPACT EL - EXTRA LARGE CABLES

FEATURES

- TE's AMPACT EL connectors can be used in high voltage applications up to 230 kV. 500 kV lines will require a corona ring.

APPLICATIONS

- Designed for use on a larger conductor that is used on transmission lines.

BENEFITS

- TE's AMPACT EL connectors can be used on solid and stranded aluminum, aluminum alloy and stranded aluminum composite conductors including AAC, AAAC, ACSR, ACAR, AW, ACSR/AW and ACSS.

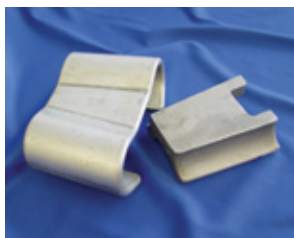

*Use yellow cartridge 69338-4, HAL - Hard Drawn Aluminum, use AMPACT tool 69611 to apply taps. Contact your TE sales representative for additional sizes.

PRODUCT SELECTION INFORMATION: DIMENSIONS IN INCHES (MM)

Catalog Number	Connector Description	Sum of Diameter	Large Groove	Small Groove
1443208-1	2500 AAC - 2500 AAC	3.648	1.824	1.824
1443209-1	1351.5 ACSR (54/19)-636 ACSR (26/7)	2.414	1.424	0.099
109423-1	1590 AAC (61)-795 AAC (61)	2.482	1.454	1.028
276915-1	1590 ACSR (45/7)-1590 ACSR (45/7)	3.008	1.504	1.504
81673-1	1590 ACSR (45/7)-1272 ACSR (45/7)	2.849	1.504	1.345
81673-2	1590 ACSR (45/7)-795 ACSR (45/7)	2.567	1.504	1.063
81673-3	1590 ACSR (45/7)-336.4 ACSR (26/7)	2.225	1.504	0.721
83086-1	1590 ACSR (45/7)-336 ACSR (26/7)	2.225	1.504	0.721
83086-2	1590 ACSR (45/7)-4/O AAC (SOL)	1.964	1.504	0.46
109424-1	1351.5 ACSR (54/19)-1351.5 ACSR (54/19)	2.848	1.424	1.424
109703-1	1351.5 ACSR (54/19)-397.5 ACSR (18/1)	2.167	1.424	0.743
276548-1	1843.2 ACSR (72/7)-795.5 ACSR (27/7)	2.712	1.604	1.108
602080-0	2500 AAC (X)-500 AAC (19), 500 CU (19)	2.635 2.634	1.824	0.811 0.810
602080-1	2500 AAC (X)-500 AAC (19), 500 CU (19)	2.635 2.634	1.824	0.811 0.810
109433-1	1272 ACSR (45/7)-954 ACSR (45/7)	2.51	1.345	1.165
276300-1	1272 ACSR (45/7), (36/1)-1272 ACSR (45/7), (36/1)	2.690 2.632	1.345 1.316	1.345 1.316
1443268-1	1272 ACSR (54/19)-1272 ACSR (54/19)	2.764	1.382	1.382
	850 mm2 HAL-660 mm2 HAL*	2.799	1.488	1.311
81698-1	2167 ACSR (72/7)-556.5 ACSR (24/7)	2.651	1.737	0.914
83861-1	143 AAC (61)-1272 ACSR (45/7)	2.724	1.379	1.345
1443259-1	1351.5 ACSR (54/19-397.5) ACSR (18/1)	2.167	1.424	0.743

Additional Sizes Available contact you local Area Sales Manager

AMPACT HTT High Temperature

FEATURES

- New contact-aid compound (corrosion inhibitor). This inhibitor compound is capable of sealing the electrical contact area of the connectors while exposed to high operating temperatures.
- Synthetic lubricant will not degrade insulating materials. It is safe to use and will not damage conductor insulation.
- Metal-to-metal contact areas are established and sealed.
- Exceeds ANSI C119.4 AA standard current cycling test specifications.
- Meets mechanical pull test and corrosion requirements.

APPLICATIONS

- Suitable for use on ACSS overhead lines operating at temperatures up to 250°C
- Accommodates a wide range of cable diameters.

BENEFITS

- Contains newly developed contact-aid compound (corrosion inhibitor) that is capable of sealing the electrical contact area of the connectors while exposed to high operating temperatures.
- Integrated, large, hard, conductive metal alloy particles scrub the conductor during wedge travel, so the conductor is abraded during the connection installation process.
- Wedge technology combined with a proprietary high-temperature corrosion inhibitor enhances connector reliability on ACSS conductors.

AMPACT



PRODUCT SELECTION INFORMATION

Catalog Number	Description	Size
1443316-2	AMPACT High Temperature Inhibitor	1-pound can

AMPACT HTT are installed with standard AMPACT tools.
 * HT Inhibitor may be purchased separately for any HT application.

AMPACT Stirrups

1

FEATURES

- Easy to install with AMPACT tooling
- Heavy duty, tin plated copper bail

APPLICATIONS

- Connects almost all solid, stranded or compressed conductor combinations

BENEFITS

- ♦ No damage to conductors when removed



PRODUCT SELECTION INFORMATION

Catalog Number	Conductor Range Size	ACSR, AAC, Conductor	Standard Bail	Part Number	Cartridge Color	Amperage
602585	Type II	#6	No. 2	69338-5	White	340 ^{††}
602586	Type II	#4, #2	No. 2	69338-5	White	340 ^{††}
1443312-1	Medium	#4, #2	No. 2	69338-1	Blue	340 ^{††}
600464	Medium	1/0 or 2/0	No. 2	69338-1	Blue	400
275436-1	Medium	1/0 or 2/0	1/0	69338-1	Blue	550
600468	Medium	2/0 or 3/0	No. 2	69338-1	Blue	400
600469	Medium	3/0 or 4/0	No. 2	69338-1	Blue	400
275435-1	Medium	3/0 or 4/0	1/0	69338-1	Blue	550
602173	Medium	3/0 or 4/0	2/0	69338-1	Blue	550 ^{††}
600463	Medium	266.8	No. 2	69338-1	Blue	400
602201	Medium	266.8	1/0	69338-1	Blue	550
602502	Medium	350 AAC	1/0	69338-1	Blue	550
276478-1	Medium	350 AAC	No. 2	69338-1	Blue	400
600474	Large	336.4	1/0	69338-4	Yellow	550
602142	Large	336.4	2/0	69338-4	Yellow	700
602136	Large	336.4	4/0	69338-4	Yellow	700
602047	Large	397.5 or 477	1/0	69338-4	Yellow	550
602143	Large	397.5 or 477	2/0	69338-4	Yellow	700
602247	Large	397.5 or 477	4/0	69338-4	Yellow	850
602104	Large	556.5	1/0	69338-4	Yellow	550
602248	Large	556.5	2/0	69338-4	Yellow	700
602115	Large	556.5	4/0	69338-4	Yellow	850
602174	Large	636	2/0	69338-4	Yellow	700
602162	Large	795	2/0	69338-4	Yellow	700
602163	Large	795	4/0	69338-4	Yellow	850
602237	Large	1033.5	4/0	69338-4	Yellow	850

AMPACT Stud Disconnect System

FEATURES

- Standard NEMA pad allows use of any size jumper conductor
- Can be easily removed in seconds
- Rated for 750 amps continuous current for demanding applications
- Lug can be attached in either orientation for maximum application flexibility
- System tested to ANSI C119.4
- Stud locking feature allows safe removal and easy hot-stick application
- Easy to park on standard parking stud

APPLICATIONS

- Attached to the circuit conductor using the AMPACT tap, a two-hole NEMA lug can be bolted to the disconnect in either orientation. The disconnect is then plugged onto the stud with hot-sticks or rubber gloves and connected/disconnected in seconds with a few turns of the eyebolt. The stud can be assembled to the line pointing up or down as required.

BENEFITS

- ♦ The AMPACT stud disconnect is an addition to the proven wedge pressure system that utilities around the world have counted on since 1958.



REPLACEMENT INFORMATION

Kit MVG 1200	Part Number
Replacement Disconnect	83471-1
Replacement Stud	83396-1

Components Part Numbers	Part Number
3/4 Disconnect MVG1200	83471-1
3/4 Stud	83396-1
1/2 Disconnect MVG900	2182405-1
1/2 Stud	83396-2

INSTRUCTION SHEET 408-9968
ENGINEERING TEST REPORT 502-47000, 502-47453 (1)

PRODUCT SELECTION INFORMATION

Conductors Accommodated	Complete Kit MVG 1200	Kit w/ Stud w/o Disconnect	Appropriate AMPACT Tap Only
1/0 AAC, ACSR to 4/0 ACSR, AAC	83470-1	83452-1	1-602031-7
266.8 AAC, ACSR to 336.4 AAC, ACSR	83470-2	83452-2	1-602031-5
477.0 AAC, ACSR to 556.5 AAC, ACSR	83470-3	83452-3	1-602031-3
795.0 AAC, ACSR	83470-4	83452-4	602121-5

Run Wires AAC/ACSR	Stud Size	Complete MVG 900 Kit (Tap, Disconnect, Stud)	Appropriate AMPACT Tap
1/0 to 2/0	1/2 inch Tinned Copper	2182452-1	600458
3/0 to 4/0	350kcm jumper or smaller	2182452-2	600465
266.8 to 336.4	350kcm jumper or smaller	2182452-3	1-602031-8
477 to 556.5		2182452-4	1-602031-6
795		2182452-5	602121-9
477 to 556.5	3/4 inch Tinned Copper	83470-3	1-602031-3
795	500kcm or 700kcm jumper	83470-4	602121-5
1033.5	500kcm or 700kcm jumper	83470-9	602180-7

Note: PN 83471-1 can only be used with 83396-1
PN 2182405-1 can only be used with 83396-2

AMPACT Identifier Plates

1

FEATURES

- Angled for easy viewing from ground
- Reduces radio frequency interference
- Lightweight
- Applied with AMPACT tool or standard wrench
- Circuit Identification
- Phase Marking
- Switch Identification
- All aluminum construction, black anodized

APPLICATIONS

- Can be installed on primary or secondary distribution conductors for field identification of circuits and/or switches.
- The improved identification accuracy can contribute to safer operation of line apparatus especially in congested circuits or multiple switch locations.

BENEFITS

- ♦ The AMPACT connectors have been incorporated into the Identifier Plate design creating simple efficient application with the AMPACT tool and cartridge
- ♦ The ID Plate is angled for easier viewing from the ground.
- ♦ Its flat, black anodized surface provides a sharp contrast to the alpha-numeric characters that can be applied to its surface.

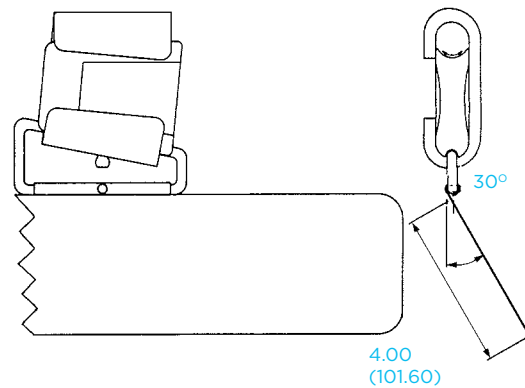

PRODUCT SELECTION INFORMATION

Catalog Number w/AMPACT Connector	Fits Conductor
83005-4	#2-1/0
83005-1	2/0-4/0 AWG
83005-5	4/0-266.8
83005-2	336.4-556.5 AAC
83005-3	795 AAC, ACSR

Plate width - 4.00 (101.60), Plate length - 15.50 (393.70).
 Note: Alpha-numeric characters not supplied with ID plate.

AMPACT Deadend Clamp Assembly

FEATURES

- Installed with standard AMPACT tools
- Simple hot-stick application
- Available as a mechanical or combination mechanical and electrical termination
- Wedge pressure technology
- Positive visual inspection
- Removable without damage to conductor
- Exceeds CSA C83.71-M87 Standard for Deadend Clamps
- Exceeds the electrical and mechanical requirements of ANSI C119.4 and CSA C57 standards

APPLICATIONS

- The AMPACT deadend clamp connector assembly fits standard stranded, All Aluminum Conductors (AAC) and Aluminum Stranded Conductors (ASC), in sizes 266.8, 336.4, 477.0, and 556.5 kcmil.

BENEFITS

- ♦ The “C” and “wedge” components come with factory applied inhibitor to enhance continued contact integrity.
- ♦ TE’s proven wedge pressure technology and components manufactured from selected aluminum alloys are combined to create a Deadend Clamp that exceeds the mechanical and electrical industry standards.
- ♦ The AMPACT deadend clamp connector assembly has been designed to simplify installation and to provide superior performance.
- ♦ A quick visual inspection of the lance on the end of the wedge is a positive verification of a proper installation, eliminating the need for torque wrenches or other special tooling.

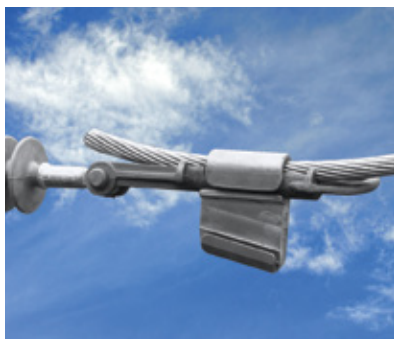

The pulling eye, an integral part of the Deadend body, is rated at 6,000 lbs, while the Deadend body is rated at 10,000 lbs. The “C” and “wedge” components are not reusable. Replacement “wedge” and “C” components can be obtained by contacting your local TE Connectivity representative

PRODUCT SELECTION INFORMATION

Style	Fits Conductor (AAC/ACSR) ¹	Catalog Number
Deadend Clamp	266.8	83589-1
	336.4	83589-2
	477	83589-3
	556.5	83589-4
	795 ACC	83589-6
	795 ACSR / 954 AAC	83589-7
Deadend Clamp w/Jumper Stud ² (3/4 [19.05] Plated Cu)	266.8	83590-1
	336.4	83590-2
	477	83590-3
	556.5	83590-4
Deadend Clamp w/Stirrup (2/0 Plated Cu Bail)	266.8	83591-1
	336.4	83591-2
	477	83591-3
	556.5	83591-4

1. Designed to fit AAC/ACSR standard stranded conductor.

2. For additional information refer to AMPACT Stud Disconnect System.

Note: The “C” and “wedge” components are not reusable. Contact your local TE representative for replacement “C” and “wedge” components or for part numbers to connect wire types/sizes not shown.

AMPACT In-Line Disconnect Switch (ILD)

1

FEATURES

- Installation with standard AMPACT tool
- Pulling-out strength in excess of 7500 lb without slipping or damage to conductor
- Copper disconnect blade assembly suspended below the insulators simplifying the cutting of conductor
- Double string of polymeric insulators prevents rolling of the switch

APPLICATIONS

- Installed on standard stranded all aluminum conductors (AAC) or aluminum conductor steel reinforced (ACSR) in conductor sizes from 1/0 to 954
- Quick, easy manual or hot-stick application

BENEFITS

- ♦ Both mechanical and electrical connection made simultaneously with the AMPACT tap
- ♦ No line tensioning devices required for installation

PRODUCT SELECTION INFORMATION: ILD 900 AMPS

Conductors Accommodated			Replacement Taps	15 kV, 110 kV		29 kV, 150 kV		35 kV, 200 kV		46 kV, 250 kV		69 kV, 350 kV	
Body Size	ACSR	AAC		With Taps	Without Taps	With Taps	Without Taps	With Taps	Without Taps	With Taps	Without Taps	With Taps	Without Taps
X-Small	1/0(6/1) 2/0(6/1)	1/0	1-83843-0	1710723-1* 1710725-1**	1710722-1* 1710724-1**	1710727-1* 1710729-1**	1710726-1* 1710728-1**	1710731-1* 1710733-1**	1710730-1* 1710732-1**	1710735-9**	1710734-4		
	3/0(6/1) 4/0(6/1)	4/0	83843-7	1710723-2* 1710725-2**	1710722-2* 1710724-2**	1710727-2* 1710729-2**	1710726-2* 1710728-2**	1710731-2* 1710733-2**	1710730-2* 1710732-2**	1710735-1	1710734-1	1710737-1	1710736-1
Small	266.8(18/1)	266.8	83843-1	1710723-3* 1710725-3**	1710722-2* 1710724-2**	1710727-3* 1710729-3**	1710726-2** 1710728-2**	1710731-3* 1710733-3**	1710730-2* 1710732-2**	1710735-2	1710734-1	1710737-2	1710736-1
	266.8(26/7) 336.4 (18/1) (26/7) (30/7)	397.5 336.4 350	83843-2	1710723-4* 1710725-4**	1710722-2* 1710724-2**	1710727-4* 1710729-4**	1710726-2* 1710728-2**	1710731-4* 1710733-4**	1710730-2* 1710732-2**	1710735-3	1710734-1	1710737-3	1710736-1
Large	397.5 (18/1) (24/7) (26/7) (30/7) 477.0 (18/1)	450 477 500	83843-3	1710723-5* 1710725-5**	1710722-3* 1710724-3**	1710727-5* 1710729-5**	1710726-3* 1710728-3**	1710731-5* 1710733-5**	1710730-3* 1710732-3**	1710735-4	1710734-2	1710737-4	1710736-2
	477.0 (26/7) 556.5 (18/1)	556.5	83843-4	1710723-6* 1710725-6**	1710722-3* 1710724-3**	1710727-5* 1710729-5**	1710726-3* 1710728-3**	1710731-6* 1710733-6**	1710730-3* 1710732-3**	1710735-5	1710734-2	1710737-5	
X-Large	477.0 (30/7) 556.5 (24/7) (26/7) (30/7) 605(24/7) (26/7) 636(18/1) (36/1)	600 636 650 700	83843-5	1710723-7* 1710725-7**	1710722-4* 1710724-4**	1710727-7* 1710729-7**	1710726-4* 1710728-4**	1710731-7* 1710733-7**	1710730-4* 1710732-4**	1710735-6	1710734-3	1710737-6	1710736-3
	605 (30/19) 636 (26/7), (24/7), (30/19) 666.6 (24/7) (26/7) 795 (36/1) (42/7) (45/7)	715.5 750 795	83843-6	1710723-8* 1710725-8**	1710722-4* 1710724-4**	1710727-8* 1710729-8**	1710728-4* 1710728-4**	1710731-8* 1710733-8**	1710730-4* 1710732-4**	1710735-7	1710734-3	1710737-7	1710736-3
	795 (24/7) (26/7) (30/7) (30/19) (54/7)	954	1-83843-1	1710723-9* 1710725-9**	1710722-4* 1710724-4**	1710727-9* 1710729-9**	1710726-4* 1710728-4**	1710731-9* 1710733-9**	1710730-4* 1710732-4**	1710735-8	1710734-3	1710737-8	1710736-3

*K-line insulators and S&C blades

**Victor insulators and Royal blades

Note: For hot-stick work you will need the following: "C" and Wedge Holder 69900, Piggy Back Clamp 69883

ILD

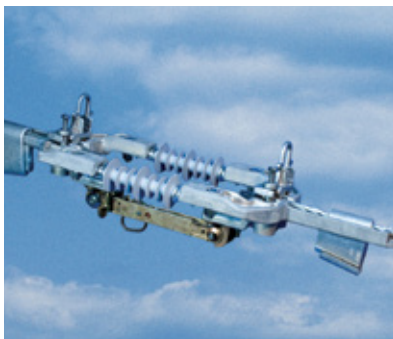

Voltage	15 kV (110 kV BIL), 29 kV (150 kV BIL), 35 kV (200 kV BIL), 46 kV (250 BIL), 69 kV (350 kV BIL)
Current	1200 Amps
Frequency	60Hz
Momentary Current	40,000 Amps
Short Time Current	25,000 Amps, 3 sec.

Technical Documents
 Instruction Sheet: PII 56078
 Engineering Test Report: 502-47376

Approvals
 RUS Listed
 ANSI: C119.4, C37.32, C37.34
 IEEE: C37.30
 CSA: C83.71

PRODUCT SELECTION INFORMATION: ILD 1200 AMPS

Conductors Accommodated			Replacement Taps	15 kV, 110 kV BIL		29 kV, 150BIL		35 kV, 200BIL	
Body Size	ACSR	AAC		With Taps	Without Taps	With Taps	Without Taps	With Taps	Without Taps
Small	266.8 (26/7) 336.4 (18/1), (26/7), (30/7)	397.5 336.4 350	83843-2	1710883-1	1710886-1	1710884-1	1710887-1	1710885-1	1710888-1
X-Large	477.0 (30/1) 556.5 (24/7),(26/7),(30/7) 605.0 (24/7),(26/7) 636 (18/1),(36/1)	600 636 650 700	83843-5	1710883-2	1710886-2	1710884-2	1710887-2	1710885-2	1710888-2
X-Large	605 (30/19) 636 (26/7),(24/7), (30/19) 666.6 (24/7),(26/7) 795 (36/1),(42/7),(45/7)	715.5 750 795	83843-6	1710883-3	1710886-2	1710884-3	1710887-2	1710885-3	1710888-2
X-Large	795 (24/7),(26/7),(30/7), (30/19) (54/7)	954	1-83843-1	1710883-4	1710886-2	1710884-4	1710887-2	1710885-4	1710888-2

Part numbers shown above use Royal Blades.

AMPACT FUSE IN-LINE MOUNT (FILM)

FEATURES

- Installation with standard AMPACT tool
- Pulling-out strength in excess of 7500 lb without slipping or damage to conductor
- Copper disconnect blade assembly suspended below the insulators simplifying the cutting of conductor
- Double string of polymeric insulators prevents rolling of the switch

APPLICATIONS

- Installed on standard stranded all aluminum conductors (AAC) or aluminum conductor steel reinforced (ACSR) in conductor sizes from 1/0 to 954
- Quick, easy manual or hot-stick application

BENEFITS

- ♦ Both mechanical and electrical connection made simultaneously with the AMPACT tap
- ♦ No line tensioning devices required for installation
- ♦ Can be used on radial feeds off of main highways
- ♦ Fuse drops down for easy location outage
- ♦ Installs in less than 10 minutes



PRODUCT SELECTION INFORMATION

Conductors Accommodated			Replacements Taps	29 kV, 150 kV BIL		L 35 kV, 200 kV BIL	
Body Size	ACSR	AAC		w/Taps	w/o Taps	w/Taps	w/o Taps
X-Small	1/0 (6/1)	1/0	1-83843-0	2182407-1	2182383-1	2182408-1	2182384-1
X-Small	12/0 (6/1)	1/0	1-83843-0	2182407-1	2182383-1	2182408-1	2182384-1
Small	3/0 (6/1)	4/0	83843-7	2182407-2	2182383-2	2182408-2	2182384-2
Small	4/0 (6/1)	4/0	83843-7	2182407-2	2182383-2	2182408-2	2182384-2
Small	266.8 (18/1)	266.8	83843-1	2182407-3	2182383-2	2182408-3	2182384-2
Small	266.8 (26/7)	336.4, 350	83843-2	2182407-4	2182383-2	2182408-4	2182384-2
Small	336.4 (18/1) (26/7) (30/7)	336.4, 350	83843-2	2182407-4	2182383-2	2182408-4	2182384-2
Large	397.5 (18/1) (24/7) (26/7) (30/7)	450, 477,	83843-3	2182407-5	2182383-3	2182408-5	2182384-3
Large	477.0 (18/1)	500	83843-3	2182407-5	2182383-3	2182408-5	2182384-3
Large	477.0 (26/7)	556.5	83843-4	2182407-6	2182383-3	2182408-6	2182384-3
Large	556.5 (18/1)	556.5	83843-4	2182407-6	2182383-3	2182408-6	2182384-3

TECHNICAL INFORMATION	
Voltage	29 kV (150 kV BIL), 35 kV (200 kV BIL)
Current	6-200 Amps
Frequency	60Hz
Short-Circuit Interrupting Rating	20kA, 16kA (Asymmetrical)
Short-Circuit Interrupting Rating	16kA, 12.8kA (Symmetrical)
Tensile Rating of Pulling Eye	6000 lbs
Dead-end Yoke assembly Rating	10,000 lbs Tensile
Hot-Stick Applications C and Wedge Holder	69900

TECHNICAL DOCUMENTS
 Instruction Sheet 408-32171
 Test Report 502-47452(I)

APPROVALS
 ANSI C119.4
 IEEE C37.40, C37.41, C37.46

Terminal Lugs

FEATURES

- Easy to install with AMPACT tooling
- Controlled contact pressure
- Aluminum alloy models
- Terminal pads have NEMA drilled bolt patterns

APPLICATIONS

- Use on overhead or pad mounted transformers
- Use as disconnectable tap or jumper connection.

BENEFITS

- ♦ Easily removable and relocated

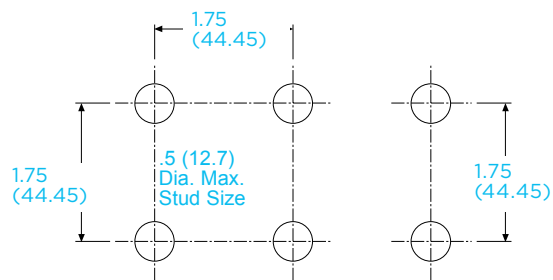
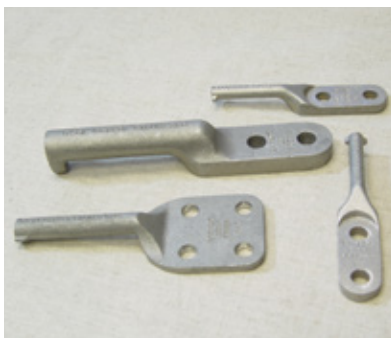

Bolt Hole Patterns

PRODUCT SELECTION INFORMATION

Catalog Number	Shank Size Conductor	Tap Groove	Ampacity*	Paddle Type
602089	#2 thru #6 1/0 thru 4/0 266.8 kcmil	4/0 Str	610	2-Hole Paddle
602097 569398-1* 602285	336.4, 397.5, 477, 556.5 kcmil 636, 795, 954, 1033.5 kcmil	336.4 Str 397.5 795 Str	895 895 1400	2-Hole Paddle
602091	#2 thru #6 1/0 thru 4/0 266.8 kcmil	4/0 Str	610	4-Hole Paddle
602099 602286	336.4, 397.5, 477, 556.5 kcmil 636, 795, 954, 1033.5 kcmil	336.4 Str 795 Str	895 1400	4-Hole Paddle
602093 602287	336.4, 397.5, 477, 556.5 kcmil 636, 795, 954, 1033.5 kcmil	336.4 Str 795 Str	895 1400	4-Hole Flag

*Current-carrying capacity in amperes at 90°C
IS 408-2116

**569398-1 has longer shank

GelPact Covers

1

FEATURES

- Made of sturdy, black, UV stable plastic
- GelPact covers are provided in packs of 18 for white and blue and in packs of 12 for yellow.
- These covers are ready to snap on quickly and start providing corrosion protection for your electrical network.
- Feature revolutionary PowerGel sealing gel which provides an excellent moisture seal over a wide temperature range (-40°C to 105°C). PowerGel sealing gel offers excellent insulating properties and acts as a vibration damper, as well.

APPLICATIONS

- Just three sizes of GelPact covers accommodate the entire AMPACT tap product line.
- GelPact W-sized covers fit all white coded taps.
- GelPact B-sized fits all blue-coded AMPACT taps.
- GelPact SMY-sized covers fit 336 up to 605 mcm.
- GelPact XL-795 covers fit 605 to 795 connectors range
- GelPact X-1033 covers fit 1033.5 connectors range

BENEFITS

- ♦ GelPact covers provide corrosion protection for AMPACT aluminum taps in severely corrosive environments such as coastal or heavily polluted areas.
- ♦ GelPact covers will prevent corrosion from forming on newly installed AMPACT taps in aerial applications.
- ♦ For previously installed AMPACT taps, installing a GelPact cover will help to arrest the progress of any corrosion that might be forming in the tap.

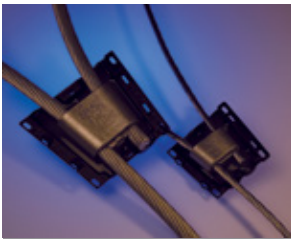

PRODUCT SELECTION INFORMATION

Catalog Number	Product Description
1710500-1	GelPact W, fits all white connectors #6 - 1/0
1710523-1	GelPact B, fits all blue connectors #6 - 4/0
1710501-1	GelPact SMY, fits all yellow connectors 336 - 605
2182763-1	GelPact XL-795, fits all yellow connectors 605 to 795
2182763-2	GelPact XL-1033, fits all yellow connectors 1033.5

Tap Covers

APPLICATIONS

- These tap covers are used to electrically insulate AMPACT taps from neighboring taps, exposed ground conductors, or nearby grounded structures in 600-volt maximum, insulated-conductor overhead applications



PRODUCT SELECTION INFORMATION: DIMENSIONS IN INCHES (MM)

Catalog Number	Color Code	Strip Style	Cover Length	Tap Size
83364-1	White	Hinged Top 82.6	3.25	Type II
602080	Blue	Hinged Top 108	4.25	Medium 266.8 and 350
602107	Yellow	Hinged Top 152	6.0	336.4, 477 and 556.5
602284	Yellow	2 Half Sections 165	6.5	795 and 1033.5

AMPACT Tool

1

FEATURES

- Conductor applications imprinted on tap packages
- Packages and labels color coded to match taps to tools and cartridges

APPLICATIONS

- Installs and removes taps even in confined spaces

BENEFITS

- Adaptable for standard hot-stick use
- Lightweight powder-actuated tools require minimum operator effort



PRODUCT SELECTION INFORMATION

Catalog Number	Product Description	Connects
69437	Small AMPACT Tool (For Red-, White-, and Blue-coded taps)	Aluminum Wire Combinations: #8 – 350 kcmil
69611	Large AMPACT Tool (For Yellow-coded taps only)	Aluminum Wire Combinations: 336.4 – 1192.5, up to 3000 MCM AMPACT EL tap connectors

USING THE AMPACT TOOL WITH THE HOT STICK

- Position "piggyback" clamp onto wire. "C" member hooked onto the wire

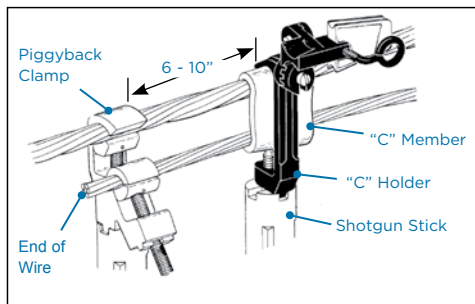

- Wedge is placed in "C" member.

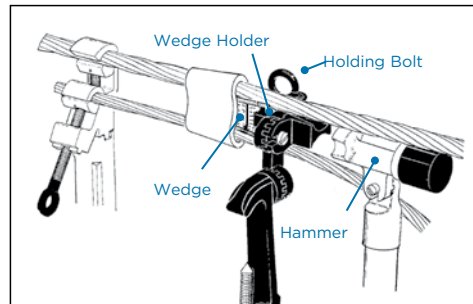

- AMPACT tool clamped over the tap.

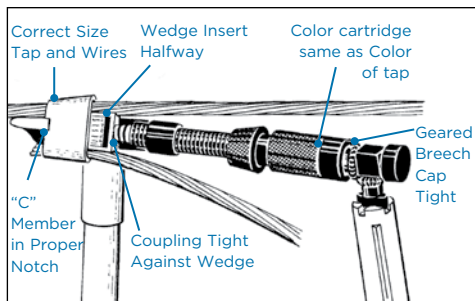

- Tap is completed by hammer blow to end of tool.

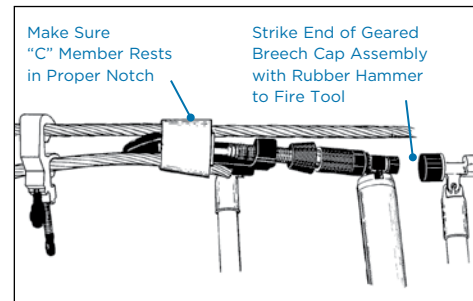

69633-2



314196-1, 5-304668-3



308967-1



47667-8



69612

REPLACEMENT PARTS

Catalog Number	Description
69633-2	Large Tool Head
47667-8	Small Tool Head
69612	Universal Power Unit
308967-1	Breech Assembly
314196-1	Breech Cap Assembly (3-Pc)
5-304668-3	Retaining Spring

AMPACT EZLoad

FEATURES

- The AMPACT EZLoad tool is a precision designed, powder actuated tool that is robust yet lightweight.
- The tool is designed with a lock and load approach.
- The cartridges are molded of weatherproof polyethylene and packed with propellant and primer.
- The color of the cartridge indicates the strength of the powder charge and corresponds to the color-code of tap sizes with which they are used.

APPLICATIONS

- AMPACT cartridges are color-coded (red etc.) and designed specifically for use in the AMPACT EZLoad tools to install AMPACT taps

BENEFITS

- ♦ This all in one design hinges on the power unit and is easily opened and closed to replace the cartridges.
- ♦ AMPACT tools are engaged by firing a special powder loaded cartridge within the tool which reduces the time and effort required to tap a power line.
- ♦ The compact tools are manufactured in high-grade steel to precise tolerances and are available in two sizes: large head and small head. The same interchangeable power unit is used in both tools.

PRODUCT SELECTION INFORMATION



Catalog Number	Description
1043413-1	AMPACT EZLoad Small tool
1443414-1	AMPACT ZLoad Large tool
1443413-2	AMPACT ZLoad Power k Adapter
1443514-1	AMPACT ZLoad Hot-Stick Adapter Kit (includes Piercer pin guide and cover)
1443470-1	AMPACT ZLoad Hot-Stick Adapter with Power Unit
1443442-1	AMPACT EZLoad Cleaning tool
1443448-1	AMPACT EZLoad Tool repair kit (included Piercer Pin guide, Piercer pin and grub screw)
69610-2	Hot-stick Kit for EZLoad tool
1443412-1	AMPACT EZLoad Power Unit

Cartridges



PRODUCT SELECTION INFORMATION

Catalog Number	Description
69338-5	White
69338-2	Red
69338-1	Blue
69338-4	Yellow

Inhibitor Compound and NEMA Interface Hinge

Inhibitor Can



NEMA Hinge



Inhibitor Bottle



PRODUCT SELECTION INFORMATION

Catalog Number	Description
80665-3	8 oz. (236 ml) plastic bottle aluminum inhibitor compound
80665-2	1 qt (.95 litre) can aluminum inhibitor compound
561118-1*	2-Hole NEMA interface hinge to protect against corrosion between dissimilar metals
69338-4	Yellow

*IS 408-2556

Cleaning Tool

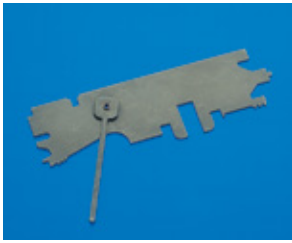

PRODUCT SELECTION INFORMATION

Catalog Number	Description
314199-1	Universal Cleaning Tool
1443442-1	Ezload Cleaning Tool

Take-Off Clip



PRODUCT SELECTION INFORMATION

Catalog Number	Description
69685-1*	For Blue-Coded Taps (and White-Coded Copper Taps)
69684	For Red-Coded Taps
69947	For Type II White-Coded Taps
69847	For Yellow-Coded Taps

*IS 408-2589

Note: Refer to Customer Manual 409-2106 for AMPACT tap removal.

Auxiliary Platform



PRODUCT SELECTION INFORMATION

Catalog Number	Description
306814	Auxiliary Platform

Notes:

- Part No. 69437 includes Take-off Clips, Part Nos. 69947 and 69685-1
- Part No. 69611 includes Take-off Clip, Part No. 69847
- Auxiliary Platform Part No. 306814-3 is required to install red-coded standard taps with Small AMPACT Tool.
- Refer to Customer Manual 409-2106 for instructions on AMPACT connector installation and removal.
- IS 408-9494 (P/N 314199-1), IS 408-9907 (P/N 69611 and 69437), IS 408-1201 (P/N 69437)

Accessory Bag



PRODUCT SELECTION INFORMATION: DIMENSIONS IN INCHES (MM)

Catalog Number	Size	Description
608338-1	12.5 (317.4) tall, 7 (177.8) dia.	Open type, brass snap-on swivel hook, white canvas
607501-1	12.5 (317.4) tall, 7 (177.8) dia.	Open type, brass snap-on swivel hook
608877-1		AMPACT Tool Kit Box

Hot-Stick

FEATURES

- Adapts AMPACT tools to standard commercial hot stick equipment
- Allows linemen to work in line with conductors instead of across them

APPLICATIONS

- The kit handles AMPACT taps and stirrups from No. 8 to 556.5-27/7 ACSR. (With additional components, it can be used on conductors to 1192.5-45/7 ACSR.)

BENEFITS

- This revolutionary tap installation method cuts down lineman exposure to energized lines.
- AMPACT tap system is adaptable for use with standard hot sticks
- With a simple hot stick adapter kit, the standard glove method is converted to the fastest hot-stick method available.



Item	Catalog Number
"C" and Wedge Holder	69900
Piggyback Clamp	69883

Note: This clamp is not intended for continuous electrical service.

PRODUCT SELECTION INFORMATION

Item	Catalog Number	Description
Geared Breech	306347-1	Replaces standard breech cap assembly
90° Adapter	69833-1	Attaches tool holders to universal hot stick, and wedge holder to "C" holder. Two adapters are included.
Small Tool Holder	306349-2	Holds small AMPACT tool No. 69437 with universal hot stick.
Large Tool Holder	306349-1	Holds large AMPACT tool No. 69611 with universal hot stick.
"C" Holder	306350-2	Used to hold the "C" member with shotgun stick, and to hook over the through and tap conductors.
Wedge Holder	306348-1	Used to hold wedge with universal hot stick.
Piggyback Clamp	69816	Hold tap conductor in position with through conductor
Adapter	1443514-1	Hot-Stick EZ Load adapter
Hammer	69674	Hot-Stick head

Accessories must be ordered separately from Hot-Stick Kit. Required for taps and stirrups in 795.0 to 1192.5 kcmil range.

306347-1



69833-1



306349-2



306349-1



306350-2



306348-1



69816



69674



69900



69883



1443514-1



Miniwedge Service Entrance Connector System

1

FEATURES

- No special tools
- Removable without conductor loss or damage
- Unique GEO-TAC surface in "C" provides higher tensile and vibration resistance
- Conductor range #14 AWG to 336.4 kcmil
- Separate insulating covers
- Wedge pressure reliability

APPLICATIONS

- Service entrance and street light applications for a range of sizes to connect from #14, #12, and #10 street light tap wire up to a 336.4 thru conductor.
- Aluminum to aluminum, aluminum to copper
- Suitable for guy, messenger and fence grounding (not for direct burial)
- MINIWEDGE connectors are for service entrance applications from #6 to #2 through 2/0 to 4/0.

BENEFITS

- ♦ Color-coded for easy connector selection for terminating standard stranded and compacted ACSR, AAAC, AAC and copper conductors.
- ♦ To enhance the mechanical and electrical performance of the service entrance connector, the AMP GEO-TAC surface is added to the inside of the "C" component during the manufacturing process.
- ♦ The GEO-TAC surface provides superior grip on the conductor to overcome the possibility of failure due to vibration and also increases the contact surface for greater electrical performance under changing load conditions



PARALLEL JAW PLIERS 109717-1

The aluminum alloy "C" and wedge components are installed with parallel jaw pliers

APPROVALS

- UL Listed
- Meets ANSI C119.4
- Part Number Series 83623 and 83630 are Certified by Canadian Standards Association, File No. LR 7189
- RUS

Note: MINIWEDGE connectors are not recommended for copper-to-copper connections. The MINIWEDGE connector with GHFC MW cover is pictured.

Miniwedge Connectors

MINIWEDGE CONNECTORS: CORE WIRE RATINGS

Special Triplex

Full ACSR, AAAC or AAC neutral

Full AAC hot wires

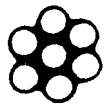

		1/0	#2	#4	#6
		1/0 ACSR, AAAC 1/0 AAC, Cu Str 1/0 AAC/Cu cmpt #2 Sol	#2 ACSR, AAAC #2 AAC, Cu Str #2 AAC/Cu cmpt #6 Sol, #4 Sol	#4 ACSR, AAAC #4 AAC, Cu Str #4 AAC/Cu cmpt	#6 ACSR, AAAC #6 AAC, Cu Str #6 AAC/Cu cmpt
#6	#6 AAC, Cu Str #6 ACSR, AAAC #6 Sol, #4 Sol	83592-4	83592-7	83592-9	1-83592-0
#4	#4 AAC, Cu Str #4 ACSR, AAAC #2 Sol	83592-3	83592-6	83592-8	
#2	#2 AAC, Cu Str #2 ACSR, AAAC	83592-2	83592-5		
1/0	1/0 ACSR, AAAC 1/0 AAC	83592-1			

Standard Triplex

Full ACSR, AAAC or AAC neutral

Full AAC hot wires

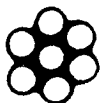

		4/0	3/0	2/0
		4/0 ACSR, AAAC 4/0 AAC, Cu Str 4/0 AAC cmpt	3/0 ACSR, AAAC 3/0 AAC, Cu Str 3/0 AAC cmpt	2/0 ACSR, AAAC 2/0 AAC, Cu Str
#2	#2 AAC, Cu Str #2 ACSR, AAAC	83631-1	83631-4	83631-7
1/0	1/0 AAC 1/0 ACSR, AAAC 2/0 AAC cmpt	83631-2	83631-5	83631-8
2/0	2/0 AAC 2/0 ACSR, AAAC	83631-3	83631-6	83631-9

Special Triplex (Smooth Body)

Full AAC or cmpt ACSR neutral

Full AAC or cmpt AAC hot wires



		1/0 (S.B.)	#2 (S.B.)	#4	#6
		1/0 ACSR cmpt 1/0 AAC, Cu Str 1/0 AAC/Cu cmpt	#2 ACSR cmpt #2 AAC, Cu Str #2 AAC/Cu cmpt #2 Sol#6 Sol, #4 Sol	#4 ACSR cmpt #4 AAC, Cu Str #4 AAC/Cu cmpt	#6 ACSR cmpt #6 AAC/Cu cmpt #6 AAC, Cu Str
#6	#6 AAC, Cu Str #6 ACC cmpt #6 ACSR cmpt #6 Sol, #4 Sol	83592-4	83592-7	83592-9	1-83592-0
#4	#4 AAC, Cu Str #4 AAC cmpt #4 ACSR cmpt #2 Sol	83592-3	83592-6	83592-8	
#2 (S.B.)	#2 AAC, Cu Str #2 AAC cmpt #2 ACSR cmpt	1-83592-2	1-83592-3		
1/0 (S.B.)	1/0 AAC 1/0 AAC cmpt 1/0 ACSR cmpt 2/0 AAC cmpt	1-83592-1			

MINIWEDGE CONNECTORS: CORE WIRE RATINGS CONTINUED

Special Triplex (Smooth Body)
Full AAC or cmpt ACSR neutral
Full AAC or cmpt AAC hot wires



		4/0 (S.B.)	3/0 (S.B.)	2/0 (S.B.)
		4/0 ACSR cmpt 4/0 AAC, Cu Str 4/0 AAC cmpt	3/0 ACSR cmpt 3/0 AAC, Cu Str 3/0 AAC cmpt	2/0 ACSR cmpt 2/0 AAC, Cu Str 2/0 AAC cmpt
#2 (S.B.)	#2 AAC cmpt #2 AAC, Cu Str #2 ACSR cmpt	1-83631-1	1-83631-4	1-83631-7
1/0 (S.B.)	1/0 AAC cmpt 1/0 AAC 1/0 ACSR cmpt	1-83631-2	1-83631-5	1-83631-8
2/0 (S.B.)	2/0 AAC cmpt 2/0 AAC 2/0 ACSR cmpt 1/0 ACSR, AAAC	1-83631-3	1-83631-6	1-83631-9

Small Street Light Tap

		1/0	#2	#4	#6	#8
		1/0 ACSR, AAAC 1/0 AAC, Cu Str 1/0 AAC/Cu cmpt 2/0 AAC/Cu cmpt	#2 ACSR, AAAC #2 AAC, Cu Str #2 AAC/Cu cmpt #2 Sol	#4 ACSR, AAAC #4 AAC, Cu Str #4 AAC/Cu cmpt #6 Sol, #4 Sol	#6 ACSR, AAAC #6 AAC, Cu Str #6 AAC/Cu cmpt	#8 AAC/Cu Str #8 Al/Cu Sol #6 Al/Cu Sol
#'s 10, 12, 14	#14 Al/Cu Str & Sol #12 Al/Cu Str & Sol #10 Al/Cu Str & Sol	83630-1	83630-3	83630-5	83630-7	83630-9
#8	#8 AAC/Cu Str #8 Al/Cu Sol #6 Al/Cu Sol	83630-2	83630-4	83630-6	83630-8	1-83630-0

Large Asymmetrical
Street Light Tap

		336.4	266.8	4/0	3/0	2/0
		336.4 AAC 266.8 ACSR (18/1) 266.8 ACSR (26/7)	266.8 ACSR (18/1) 266.8 AAC 336.4 AAC cmpt	4/0 ACSR 4/0 AAC 266.8 AAC cmpt	3/0 ACSR 3/0 AAC 4/0 AAC cmpt	2/0 ACSR 2/0 AAC 3/0 AAC cmpt
#'s 10, 12, 14	#14 Al/Cu Str & Sol #12 Al/Cu Str & Sol #10 Al/Cu Str & Sol	1-83623-7	1-83623-3	83623-9	83623-5	83623-1
#8	#8 AAC/Cu Str & Sol #6 Al/Cu Sol	1-83623-8	1-83623-4	1-83623-0	83623-6	83623-2
#6	#6 AAC/Cu Str & Sol #6 ACSR #4 Al/Cu Sol	1-83623-9	1-83623-5	1-83623-1	83623-7	83623-3
#4	#4 AAC/Cu Str #4 ACSR #2 Al/Cu Sol	2-83623-0	1-83623-6	1-83623-2	83623-8	83623-4

NOTE: Wire must fit in small Diameter range and Large diameter range. Sum of both wires must fit within the Min and Max of sum of diameters.

PRODUCT SELECTION INFORMATION: DIMENSIONS IN INCHES (MM)

Catalog Number	Wire Marking		Sum of Diameters		Groove 1 Diameter		Groove 2 Diameter	
	Groove 1	Groove 2	max	min	max	min	max	min
Core								
83592-1	1/0	1/0	.796 (20.22)	.696 (17.68)	.398 (10.11)	.315 (8.00)	.398 (10.11)	.315 (8.00)
83592-2	1/0	#2	.723 (18.36)	.618 (15.70)	.398 (10.11)	.315 (8.00)	.336 (8.53)	.260 (6.60)
83592-3	1/0	#4	.656 (16.66)	.549 (13.94)	.398 (10.11)	.315 (8.00)	.268 (6.81)	.205 (5.21)
83592-4	1/0	#6	.602 (15.29)	.498 (12.65)	.398 (10.11)	.315 (8.00)	.215 (5.46)	.138 (3.51)
83592-5	#2	#2	.650 (16.51)	.550 (13.97)	.336 (8.53)	.260 (6.60)	.336 (8.53)	.260 (6.60)
83592-6	#2	#4	.583 (14.81)	.481 (12.22)	.336 (8.53)	.260 (6.60)	.268 (6.81)	.205 (5.21)
83592-7	#2	#6	.529 (13.44)	.429 (10.90)	.336 (8.53)	.260 (6.60)	.215 (5.46)	.138 (3.51)
83592-8	#4	#4	.516 (13.11)	.416 (10.57)	.268 (6.81)	.205 (5.21)	.268 (6.81)	.205 (5.21)
83592-9	#4	#6	.462 (11.73)	.362 (9.19)	.268 (6.81)	.205 (5.21)	.215 (5.46)	.138 (3.51)
1-83592-0	#6	#6	.408 (10.36)	.308 (7.82)	.215 (5.46)	.138 (3.51)	.215 (5.46)	.138 (3.51)
1-83592-1	1/0 SB	1/0 SB	.752 (19.10)	.652 (16.56)	.398 (10.11)	.315 (8.00)	.398 (10.11)	.315 (8.00)
1-83592-2	1/0 SB	#2 SB	.670 (17.02)	.570 (14.48)	.398 (10.11)	.315 (8.00)	.336 (8.53)	.260 (6.60)
1-83592-3	#2 SB	#2 SB	.600 (15.24)	.500 (12.70)	.336 (8.53)	.260 (6.60)	.336 (8.53)	.260 (6.60)
Service Connectors								
83631-1	4/0	#2	.888 (22.56)	.788 (20.02)	.570 (14.48)	.473 (12.01)	.336 (8.53)	.260 (6.60)
83631-2	4/0	1/0	.961 (24.41)	.861 (21.87)	.570 (14.48)	.473 (12.01)	.398 (10.11)	.315 (8.00)
83631-3	4/0	2/0	1.010 (25.65)	.907 (23.04)	.570 (14.48)	.473 (12.01)	.470 (11.94)	.375 (9.53)
83631-4	3/0	#2	.827 (21.01)	.731 (18.57)	.515 (13.08)	.420 (10.67)	.336 (8.53)	.260 (6.60)
83631-5	3/0	1/0	.900 (22.86)	.809 (20.55)	.515 (13.08)	.420 (10.67)	.398 (10.11)	.315 (8.00)
83631-6	3/0	2/0	.949 (24.10)	.849 (21.56)	.515 (13.08)	.420 (10.67)	.470 (11.94)	.375 (9.53)
83631-7	2/0	#2	.772 (19.61)	.682 (17.32)	.470 (11.94)	.375 (9.53)	.336 (8.53)	.260 (6.60)
83631-8	2/0	1/0	.845 (21.46)	.760 (19.30)	.470 (11.94)	.375 (9.53)	.398 (10.11)	.315 (8.00)
83631-9	2/0	2/0	.894 (22.71)	.800 (20.32)	.470 (11.94)	.375 (9.53)	.470 (11.94)	.375 (9.53)
1-83631-1	4/0 SB	#2 SB	.820 (20.83)	.720 (18.29)	.570 (14.48)	.473 (12.01)	.336 (8.53)	.260 (6.60)
1-83631-2	4/0 SB	1/0 SB	.901 (22.89)	.811 (20.60)	.570 (14.48)	.473 (12.01)	.398 (10.11)	.315 (8.00)
1-83631-3	4/0 SB	2/0 SB	.942 (23.93)	.851 (21.62)	.570 (14.48)	.473 (12.01)	.470 (11.94)	.375 (9.53)
1-83631-4	3/0 SB	#2 SB	.756 (19.20)	.660 (16.76)	.515 (13.08)	.420 (10.67)	.336 (8.53)	.260 (6.60)
1-83631-5	3/0 SB	1/0 SB	.837 (21.26)	.759 (19.28)	.515 (13.08)	.420 (10.67)	.398 (10.11)	.315 (8.00)
1-83631-6	3/0 SB	2/0 SB	.878 (22.30)	.799 (20.29)	.515 (13.08)	.420 (10.67)	.470 (11.94)	.375 (9.53)
1-83631-7	2/0 SB	#2 SB	.706 (17.93)	.620 (15.75)	.470 (11.94)	.375 (9.53)	.336 (8.53)	.260 (6.60)
1-83631-8	2/0 SB	1/0 SB	.787 (19.99)	.700 (17.78)	.470 (11.94)	.375 (9.53)	.398 (10.11)	.315 (8.00)
1-83631-9	2/0 SB	2/0 SB	.828 (21.03)	.740 (18.80)	.470 (11.94)	.375 (9.53)	.470 (11.94)	.375 (9.53)
Large Asymmetrical Street Light								
2-83623-0	336.4	#4	.924 (23.47)	.822 (20.88)	.675 (17.15)	.590 (14.99)	.268 (6.81)	.205 (5.21)
1-83623-9	336.4	#6	.870 (22.10)	.771 (19.58)	.675 (17.15)	.590 (14.99)	.215 (5.46)	.138 (3.51)
1-83623-8	336.4	#8	.828 (21.03)	.725 (18.42)	.675 (17.15)	.590 (14.99)	.198 (5.03)	.115 (2.92)
1-83623-7	336.4	#10 - #14	.782 (19.86)	.673 (17.09)	.675 (17.15)	.590 (14.99)	.125 (3.18)	.055 (1.40)
1-83623-6	266.8	#4	.867 (22.02)	.788 (20.02)	.620 (15.75)	.540 (13.72)	.268 (6.81)	.205 (5.21)
1-83623-5	266.8	#6	.813 (20.65)	.737 (18.72)	.620 (15.75)	.540 (13.72)	.215 (5.46)	.138 (3.51)
1-83623-4	266.8	#8	.771 (19.58)	.691 (17.55)	.620 (15.75)	.540 (13.72)	.198 (5.03)	.115 (2.92)
1-83623-3	266.8	#10-#14	.725 (18.42)	.639 (16.23)	.620 (15.75)	.540 (13.72)	.125 (3.18)	.055 (1.40)
1-83623-2	4/0	#4	.821 (20.85)	.720 (18.29)	.570 (14.48)	.473 (12.01)	.268 (6.81)	.205 (5.21)
1-83623-1	4/0	#6	.767 (19.48)	.669 (16.99)	.570 (14.48)	.473 (12.01)	.215 (5.46)	.138 (3.51)
1-83623-0	4/0	#8	.725 (18.42)	.623 (15.82)	.570 (14.48)	.473 (12.01)	.198 (5.03)	.115 (2.92)
83623-9	4/0	#10-#14	.679 (17.25)	.571 (14.50)	.570 (14.48)	.473 (12.01)	.125 (3.18)	.055 (1.40)
83623-8	3/0	#4	.760 (19.30)	.662 (16.81)	.515 (13.08)	.420 (10.67)	.268 (6.81)	.205 (5.21)
83623-7	3/0	#6	.706 (17.93)	.611 (15.52)	.515 (13.08)	.420 (10.67)	.215 (5.46)	.138 (3.51)
83623-6	3/0	#8	.664 (16.87)	.565 (14.35)	.515 (13.08)	.420 (10.67)	.198 (5.03)	.115 (2.92)
83623-5	3/0	#10 - #14	.618 (15.70)	.513 (13.03)	.515 (13.08)	.420 (10.67)	.125 (3.18)	.055 (1.40)
83623-4	2/0	#4	.705 (17.91)	.613 (15.57)	.470 (11.94)	.375 (9.53)	.268 (6.81)	.205 (5.21)
83623-3	2/0	#6	.651 (16.54)	.562 (14.27)	.470 (11.94)	.375 (9.53)	.215 (5.46)	.138 (3.51)
83623-2	2/0	#8	.609 (15.47)	.516 (13.11)	.470 (11.94)	.375 (9.53)	.198 (5.03)	.115 (2.92)
83623-1	2/0	#10 - #14	.563 (14.30)	.464 (11.79)	.470 (11.94)	.375 (9.53)	.125 (3.18)	.055 (1.40)
Small Street Light								
83630-1	1/0	#10-#14	.514 (13.06)	.400 (10.16)	.398 (10.11)	.315 (8.00)	.125 (3.18)	.055 (1.40)
83630-2	1/0	#8	.560 (14.22)	.460 (11.68)	.398 (10.11)	.315 (8.00)	.198 (5.03)	.115 (2.92)
83630-3	#2	#10-#14	.441 (11.20)	.332 (8.43)	.336 (8.53)	.260 (6.60)	.125 (3.18)	.055 (1.40)
83630-4	#2	#8	.487 (12.37)	.384 (9.75)	.336 (8.53)	.260 (6.60)	.198 (5.03)	.115 (2.92)
83630-5	#4	#10-#14	.374 (9.50)	.274 (6.96)	.268 (6.81)	.205 (5.21)	.125 (3.18)	.055 (1.40)
83630-6	#4	#8	.420 (10.67)	.320 (8.13)	.268 (6.81)	.205 (5.21)	.198 (5.03)	.115 (2.92)
83630-7	#6	#10-#14	.320 (8.13)	.220 (5.59)	.215 (5.46)	.138 (3.51)	.125 (3.18)	.055 (1.40)
83630-8	#6	#8	.366 (9.30)	.266 (6.76)	.215 (5.46)	.138 (3.51)	.198 (5.03)	.115 (2.92)
83630-9	#8	#10-#14	.278 (7.06)	.178 (4.52)	.198 (5.03)	.115 (2.92)	.125 (3.18)	.055 (1.40)
1-83630-0	#8	#8	.324 (8.23)	.224 (5.69)	.198 (5.03)	.115 (2.92)	.198 (5.03)	.115 (2.92)

GHFC MW Closure

1

FEATURES

- Simply install by snapping the closure over the connector.

APPLICATIONS

- Specifically designed to provide sealing and corrosion protection for MINIWEDGE connectors installed overhead for corrosion protection or in direct buried applications up to 1000 volts

BENEFITS

- ♦ Suitable for aluminum-to-aluminum and aluminum-to-copper connections.
- ♦ Fits most MINIWEDGE connector applications.



PRODUCT SELECTION INFORMATION: DIMENSIONS IN INCHES (MM)

Catalog Number	Part Number	Description	Main	Tap	Std. Pack
GHFC-MW	3-1199125-2	Gel cover for sealing and insulating	#8-4/0 (10-95)	#14-2/0 (1.5-70)	10

ADDITIONAL PRODUCT INFORMATION

- Package does not contain MINIWEDGE connectors, which must be ordered separately
- Standard package: 10 kits/box
- Related test reports: EDR-5340, 502-47233

AMPACT Copper Wire Taps

FEATURES

- Compact, lightweight application tool permits easy installation almost anywhere, without bulky equipment, heat, or external power
- AMPACT copper taps are made of quality alloys for low resistivity and superior corrosion resistance
- A locking tab prevents the tapered locked wedge from loosening once it has been driven into position
- The tap's "C" member is composed of an aluminum bronze alloy and the wedge of a copper alloy very close to pure copper.
- Built-in spring tension causes the tap to maintain constant mechanical pressure for optimum electrical conductivity.
- Resist corrosion and will not loosen.

APPLICATIONS

- Unique design incorporating a tapered "C" member and wedge, provides firm, sure contact for consistent, all weather, wire-to-wire, low resistance grounding connections
- The taps will provide secure connections on both stranded wire or solid rod.

BENEFITS

- ♦ Taps will not penetrate copper plating, allowing secure connections from copper conductors to ground rods, reinforcing bars or conductors of any type
- ♦ Electrical joints are stable and effective for optimum electrical contact, even under conditions of creep and cold flow.
- ♦ Connectors may be checked visually – speeding inspection and practically eliminating callbacks
- ♦ Simple installation system greatly reduces exposure to energized lines
- ♦ When properly matched and applied, AMPACT taps exceed the current-carrying capacity of the conductors they are connecting.
- ♦ Taps stay permanently locked during power surges, yet may be removed if necessary without damage to cables or rods.

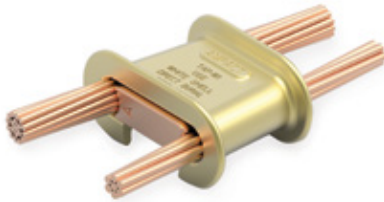

GROUND ROD APPLICATIONS, COPPER-CLAD: DIMENSIONS IN INCHES (MM)

Designated Size	Wire Size	Actual Diameter
3/8 (9.53)	1/0 AWG	.355 (9.02)
1/2 (12.70)	3/0 AWG	.475 (12.06)
5/8 (15.88)	250 kcmil	.563 (14.30)
3/4 (19.05)	350 kcmil	.682 (17.32)

Galvanized Steel		
Designated Size	Wire Size	Actual Diameter
3/8 (9.53)	1/0 AWG	.375 (9.53)
1/2 (12.70)	3/0 AWG	.500 (12.70)
5/8 (15.88)	300 kcmil	.625 (15.88)
3/4 (19.05)	450 kcmil	.750 (19.05)



Listed by Underwriters Laboratories Inc., File No. E69905



Certified by Canadian Standards Association, File No. LR 56476
REA Letter of Technical Acceptance (Grounding Taps)

Technical Documents
Customer Manual: 409-2106
Department Publications: 410-5810, 410-5811
Product Specifications: 108-13011, 108-13012, 108-13015
Safety Publication: 125-6217
General Publication: 408-3010-1 through -4

PRODUCT SELECTION INFORMATION: DIMENSIONS IN INCHES (MM)

Groove Size kcmil or AWG	Groove Code	Conductor Diameter	
		Min	Max
500	A	.785 (19.9)	.813 (20.7)
450	B	.745 (18.9)	.784 (19.9)
400	E	.700 (17.8)	.744 (18.9)
350	G	.650 (16.5)	.699 (17.8)
300	H	.620 (15.7)	.649 (16.5)
250	K (R)**	.561 (14.2)	.625 (15.9)
4/0	L	.506 (12.9)	.560 (14.2)
3/0	M	.451 (11.5)	.505 (12.8)
2/0	N	.401 (10.2)	.450 (11.4)
1/0	O	.355 (9.0)	.400 (10.2)
No. 2	T	.280 (7.1)	.354 (9.0)
No. 4	W	.216 (5.5)	.279 (7.1)
No. 6	X	.182 (4.6)	.215 (5.5)

AMPACT COPPER TAP SELECTION FOR WIRE TO GROUND ROD[†] OR SOLID PIN

Copper Conductor (kcmil/AWG)	3/8"	1/2"	5/8"		3/4"	
	Ground Rod/Pin Dia. Range .355-.375 (9.02-9.53)	Ground Rod/Pin Dia. Range .475-.500 (12.07-12.7)	Ground Rod Dia. .563 (14.3)	Ground Rod/Pin Dia. .625 (15.88)	Ground Rod Dia. .682 (17.32)	Ground Rod/Pin Dia. .750 (19.05)
500	1-276337-4	1-276337-3	276337-9	1-276337-2	1-276337-1	276337-1
450	2-276337-5	2-276337-4	2-276337-3	2-276337-2	2-276337-1	1-276337-9
400	3-276337-7	3-276337-5	3-276337-3	3-276337-2	3-276337-1	2-276337-0
350	4-276337-9	4-276337-7	4-276337-5	4-276337-4	4-276337-3	2-276337-1
300	6-276337-0	5-276337-8	5-276337-6	5-276337-5	4-276337-4	2-276337-2
250	275187-4	275187-2	2-275187-8	5-276337-6	4-276337-5	2-276337-3
4/0	275187-9	275187-7	275187-1	5-276337-7	4-276337-6	276337-2
3/0	1-275187-3	1-275187-1	275187-2	5-276337-8	4-276337-7	2-276337-4
2/0	1-275187-6	1-275187-2	275187-3	5-276337-9	4-276337-8	276337-3
1/0	1-275187-8	1-275187-3	275187-4	6-276337-0	4-276337-9	2-276337-5
No. 2	2182410-1	1-275187-4	275187-5	6-276337-2	5-276337-1	276337-4
No. 4	2182410-1	3-275187-6	3-275187-0	6-276337-4	5-276337-3	2-276337-8
No. 6	2182410-2	3-275187-7	3-275187-1	6-276337-5	5-276337-4	2-276337-9

[†]Some Ground Rods have a designated or descriptive diameter that is different from the Actual Diameter. The Actual Diameter must be determined and used with the top chart for correct tap selection.

AMPACT COPPER TAP SELECTION FOR WIRE-TO-WIRE APPLICATIONS

Typical Example:

500 to 350 kcmil = Groove Code AG = Part No. 1-276337-1

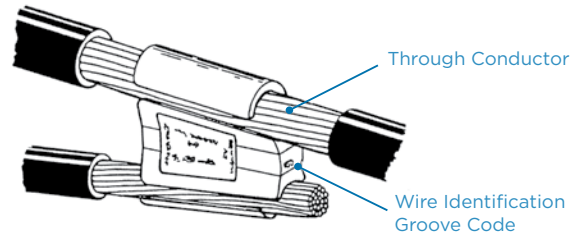

Wire Size	White Shells (69338-5)								Blue Shells (69338-1)					Yellow Shells (69338-4)
	X 5,6	W 4	T 2	O 1/0	N 2/0	M 3/0	L 4/0	K (R) 250	H 300	G 350	E 400	B 450	A 500	750 (61)
X 5,6	2182410-4	2182410-4	2182410-2	2182410-2	4-275187-0	3-275187-7	3-275187-4	3-275187-1	6-276337-5	5-276337-4	4-276337-2	2-276337-9	1-276337-8	1-81723-3*
W 4		2182410-3	2182410-2	2182410-1	3-275187-9	3-275187-6	3-275187-3	3-275187-0	6-276337-4	5-276337-3	4-276337-1	2-276337-8	1-276337-7	1-81723-3*
T 2			2182410-1	2182410-1	1-275187-7	1-275187-4	1-275187-0	275187-5	6-276337-2	5-276337-1	3-276337-9	276337-4	276337-8	1-81723-2*
O 1/0				1-275187-8	1-275187-6	1-275187-3	275187-9	275187-4	6-276337-0	4-276337-9	3-276337-7	2-276337-5	1-276337-4	1-81723-2*
N 2/0					1-275187-5	1-275187-2	275187-8	275187-3	5-276337-9	4-276337-8	3-276337-6	276337-3	276337-7	1-81723-1*
M 3/0						1-275187-1	275187-7	275187-2	5-276337-8	4-276337-7	3-276337-5	2-276337-4	1-276337-3	1-81723-0*
L 4/0							275187-6	275187-1	5-276337-7	4-276337-6	3-276337-4	276337-2	276337-6	81723-9*
K (R) 250									5-276337-6	4-276337-5	3-276337-3	2-276337-3	276337-9	81723-8*
H 300									5-276337-5	4-276337-4	3-276337-2	2-276337-2	1-276337-2	81723-7
G 350										4-276337-3	3-276337-1	2-276337-1	1-276337-1	81723-6
E 400											3-276337-0	2-276337-0	1-276337-0	81723-5
B 450												1-276337-9	276337-1	81723-4
A 500													276337-5	81723-2
750 (61)														81723-1

AMPACT COPPER WIRE TAPS

Tap	Cartridge
275187-1	69338-5
275187-2	69338-5
275187-3	69338-5
275187-4	69338-5
275187-5	69338-5
275187-6	69338-5
275187-7	69338-5
275187-8	69338-5
275187-9	69338-5
1-275187-0	69338-5
1-275187-1	69338-5
1-275187-2	69338-5
1-275187-3	69338-5
1-275187-4	69338-5
1-275187-5	69338-5
1-275187-6	69338-5
1-275187-7	69338-5
1-275187-8	69338-5
2-275187-8	69338-5
3-275187-0	69338-5
3-275187-1	69338-5
3-275187-3	69338-5
3-275187-4	69338-5
3-275187-6	69338-5
3-275187-7	69338-5
3-275187-9	69338-5
4-275187-0	69338-5
276337-1	69338-1
276337-2	69338-1
276337-3	69338-1
276337-4	69338-1
276337-5	69338-1
276337-6	69338-1
276337-7	69338-1
276337-8	69338-1
276337-9	69338-1
1-276337-0	69338-1
1-276337-1	69338-1
1-276337-2	69338-1
1-276337-3	69338-1
1-276337-4	69338-1
1-276337-7	69338-1
1-276337-8	69338-1

Tap	Cartridge
1-276337-9	69338-1
2-276337-0	69338-1
2-276337-2	69338-1
2-276337-3	69338-1
2-276337-4	69338-1
2-276337-5	69338-1
2-276337-8	69338-1
2-276337-9	69338-1
3-276337-0	69338-1
3-276337-1	69338-1
3-276337-2	69338-1
3-276337-3	69338-1
3-276337-4	69338-1
3-276337-5	69338-1
3-276337-6	69338-1
3-276337-7	69338-1
3-276337-9	69338-1
4-276337-1	69338-1
4-276337-2	69338-1
4-276337-3	69338-1
4-276337-4	69338-1
4-276337-5	69338-1
4-276337-6	69338-1
4-276337-7	69338-1
4-276337-8	69338-1
4-276337-9	69338-1
5-276337-1	69338-1
5-276337-3	69338-1
5-276337-4	69338-1
5-276337-5	69338-1
5-276337-6	69338-1
5-276337-7	69338-1
5-276337-8	69338-1
5-276337-9	69338-1
6-276337-0	69338-1
6-276337-2	69338-1
6-276337-4	69338-1
6-276337-5	69338-1
2182410-1	69338-5
2182410-2	69338-5
2182410-3	69338-5
2182410-4	69338-5

Copper Terminal Lug

1

FEATURES

- Controlled contact pressure
- NEMA-type terminal

APPLICATIONS

- Use as disconnectable tap or jumper connection

BENEFITS

- ♦ Easily removable and relocated
- ♦ Easy to install with AMPACT tooling



PRODUCT SELECTION INFORMATION

Catalog Number	Shank Size Conductor	Tap Groove	Paddle Type
602089-3	#2 to 500 kcmil Copper Cable	4/0 STR	Copper 2-Hole Paddle
602099	#2 to 500 kcmil Copper Cable	4/0 STR	Copper 4-Hole Paddle

SHEAR-LOK Copper Tap/Grounding Connector

FEATURES

- Wedge Pressure Technology
- Shear-head bolt—controlled torque
- Removable without conductor damage
- No special tools

APPLICATIONS

- This family of connectors is ideal for pole grounds, transmission grounding, Telco and CATV applications where connections must be made between conductor and rods, specifically in the range of #10, #6, #4, to both 5/8" and 3/4" copper clad galvanized rods.
- Developed for applications in the power utility industry where connectors are required to withstand mid-range (20 kA symmetrical RMS) magnitudes of fault current.

BENEFITS

- ♦ Application not inhibited by disfigured ground rod end
- ♦ Taps into existing ground conductors

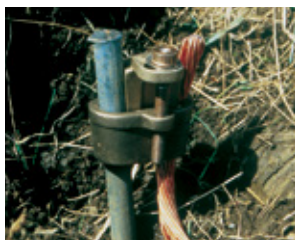

File No. E69905
Grounding & Bonding
Including Direct
Burial.



Certified by
Canadian Standards
Association.

PRODUCT SELECTION INFORMATION: DIMENSION IN INCHES (MM)

Catalog Number	Connects Rod To	Conductor
83000-1*	5/8" Cu Clad Dia .562 (14.30)	1/0 Str.
80408-2**	5/8" Cu Clad Dia .562 (14.30)	#6 Sol. or Strd. or #4 Sol. or Strd.
80408-2**	5/8" Galv. Dia .562 (15.88)	#6 Sol. or Strd.
80408-3	3/4" Cu Clad Dia .682 (17.32)	#6 Sol. or Strd.
80408-4**	3/4" Cu Clad Dia .682 (17.32)	#4 Sol. or Strd.
80408-4**	3/4" Galv. Dia .750 (19.05)	#6 Sol. or Strd.
80408-5	3/4" Galv. Dia .750 (19.05)	#4 Sol. or Strd.
80408-6*	3/4" Cu Clad Dia .682 (17.32)	1/0 Str.
80408-7	5/8" Cu Clad Dia .562 (14.30)	#6 Sol., #8 Sol., Strd. or #10 Sol., Strd.
80408-8	5/8" Cu Clad Dia .562 (14.30)	#2 Sol, Str Cu

*UL Listed File No. E69905 Grounding & Bonding Including Direct Burial

† CSA Certified

TECHNICAL DOCUMENT

Instruction Sheet 408-9921

AMP Weld Exothermically Welded Grounding Connections

FEATURES

- Products tested to IEEE 837-2014
- Premium weld material
- Complete fusion of copper conductors
- Harsh environment testing protocol

APPLICATIONS

- Substation
- Transmission
- Lightning Protection
- Telecommunications
- Datacomm
- Commercial / Industrial

BENEFITS

- ♦ Proper grounding and bonding is critical to the effective operation of all electrified systems: power, telecommunications, and data communications. It is also vital for the protection of people and equipment. The common elements that comprise all grounding systems are conductors, electrodes, and connectors. Connectors vary by application, but for high current permanent grounds, exothermic connections are the superior technology.

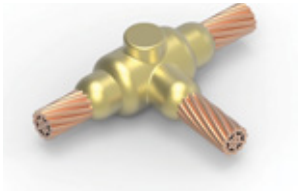

TE250-4/0A

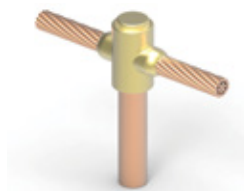

GC2/0-3/4A



HE

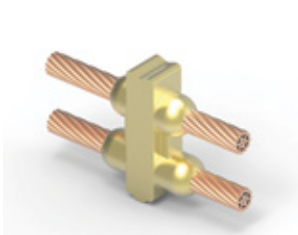

PR250-250B-HD

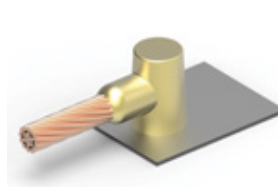

HE750-B

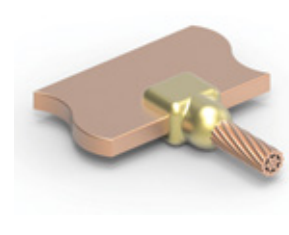

WBE



RTE4-1/0A

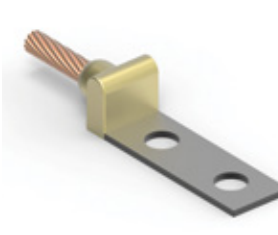

LBT

WRENCH-LOK Electrical Grounding Connector

1

FEATURES

- Uses a specially designed shear-head bolt to drive a tapered wedge into the connector body
- WRENCH-LOK connectors require no special training, no special tools, no auxiliary power, and they can be installed in any weather.

APPLICATIONS

- The product line offers options to connect conductor-to-conductor or conductor-to-ground rod.

BENEFITS

- ♦ Provides a superior, fool-proof connection while reducing application time dramatically
- ♦ All that's needed to apply it is a common ratchet or socket wrench
- ♦ When the connection is tightened to the proper torque, the bolt head shears off, giving a positive visual indication of a perfect connection
- ♦ No need to change connector styles, molds or tooling.



Listed by Underwriters Laboratories Inc., File No. E69905

REA

Meets requirements of IEEE STD 837

Certified by Canadian Standards Association, File No. LR56476

TEST RESULTS FOR COPPER GROUND GRID CONNECTORS

IEEE Standard 837

Overall, connectors meet all requirements necessary to be considered qualified for permanent grounding connections used in substation grounding.

Mechanical Pullout

Connectors exceeded min. standard pullout requirements by wide margin.

Electromagnetic Force

Connectors withstood high mechanical and heating stresses of short circuit currents, well within standard.

Sequential Tests

Current-Temperature Cycling

Connectors ran much cooler than control conductor and resistance remained low and stable.

Freeze-Thaw

Resistance of connectors remained stable, demonstrating connectors are not affected by extreme temperature changes.

Corrosion-Nitric Acid

Acid did not penetrate contact interface and resistance remained stable.

Fault Current

Connectors withstood severe mechanical and heating stresses with very slight increase in joint resistance, well within standard.

Thermal Shock and Accelerated Corrosion

Stable performance indicates connectors will not be adversely affected by extreme environmental conditions.

Torque of Bolt vs. Resistance of Connection

Connection resistance stable at point much below nominal torque.

Torque of Bolt vs. Deflection

Connector designed with sufficient strength and spring qualities to maintain body resilient contact force for dependable, long-term connection.

Tensile vs. Deflection

Connector body designed with sufficient strength to withstand extreme overload mechanical forces.

TECHNICAL DOCUMENT

Department Publication: 410-5812

Instruction Sheet: 408-9504

PRODUCT SELECTION INFORMATION

GROUND ROD-TO-CONDUCTOR

3/8		1/2		5/8		3/4		Conductor
Copper Clad .355 (9.02)	Galv. Steel .375 (9.52)	Copper Clad .475 (12.06)	Galv. Steel .500 (12.70)	Copper Clad .563 (14.30)	Galv. Steel .625 (15.88)	Copper Clad .682 (17.32)	Galv. Steel .750 (19.05)	
83747-2	83747-2	83747-4	83747-4	83749-1	83749-2	83749-3	83749-4	#2 sol, str, cmpt
83747-3	83747-3	83749-1	83749-1	83749-2	83749-3	83749-4	83748-3	1/0 str, cmpt
83747-4	83747-4	83749-2	83749-2	83749-3	83748-1	83748-3	83748-4	2/0 str, cmpt
		83749-2	83749-3	83748-1	83748-2	83748-4	83751-1	3/0 str, cmpt
		83748-1	83748-1	83748-2	83748-4	83751-1	83751-2	4/0 str, cmpt
				83750-1	83748-4	83751-1	83751-2	250 compacted
				83750-1	83751-1	83751-2	83751-3	250 str
					83751-1	83751-2	83751-3	300 compacted
					83751-2	83751-3	83751-4	300 str
					83751-2	83751-3	83751-4	350 compacted
						83751-3	83750-2	350 str
						83751-3	83751-4	400 compacted
							83750-3	500 str

CONDUCTOR-TO-CONDUCTOR (STANDARD ROUND)

#2 sol, str	1/0 str	2/0 str	3/0 str	4/0 str	250 str	300 str	350 str	400 str	500 str	Conductor
83747-1	83747-2	83747-1	83747-3	83747-4	83747-1	83749-2	83749-3	83749-4	-	#2 sol, str
	83747-3	83747-1	83747-4	83749-1	83749-2	83749-3	83748-1	83749-3	83751-1	1/0 str
		83747-1	83749-1	83749-2	83749-3	83748-1	83748-2	83748-3	83751-1	2/0 str
			83749-2	83749-3	83748-1	83748-2	83748-3	83748-4	83751-2	3/0 str
				83748-2	83748-2	83748-4	83751-1	83751-1	83751-3	4/0 str
					83750-1	83751-1	83751-2	83751-2	83751-4	250 str
						83750-2	83751-2	83751-3	83750-2	300 str
							83751-3	83751-4	83750-3	350 str
								83750-2	83750-5	400 str
									83750-4	450 str
									83750-6	500 str

CONDUCTOR-TO-CONDUCTOR (COMPACTED)

#2	1/0	2/0	3/0	4/0	250	300	350	400	500 str	Conductor
83747-1	83747-2	83747-2	83747-3	83747-4	83747-4	83749-1	83749-2	83749-3	83749-4	#2
	83747-3	83747-3	83747-4	83749-1	83749-2	83749-2	83749-3	83749-1	83749-3	1/0
		83747-4	83747-1	83749-2	83749-2	83749-3	83748-1	83748-2	83748-4	2/0
			83749-2	83749-3	83748-1	83748-1	83748-2	83748-3	83751-1	3/0
				83748-1	83748-2	83748-2	83748-4	83748-4	83751-1	4/0
					83750-1	83750-1	83748-4	83751-1	83751-2	250
						83750-1	83751-1	83751-1	83751-3	300
							83751-2	83751-2	83751-3	350
								83751-3	83749-4	400
									83750-2	450
									83750-3	500

REPLACEMENT BOLTS PART NUMBERS

Small Body 81249-4
Large Body 81249-2

Conductors listed are for Stranded Copper Standard Round

PRODUCT SELECTION INFORMATION

Catalog Number Small Body	Description Standard Round	Compacted	Conductor to Ground Rod
83747-1	#2 sol., str.-#2 sol., str.	2-#2	
83747-2	1/0, 2/0 str.-#2 sol., str.	1/0, 2/0-#2	3/8 Clad or Galv.-#2
83747-3	1/0, 2/0 str.-1/0 str.	1/0, 2/0-1/0	3/8 Clad or Galv.-1/0
	3/0 str.-#2 sol., str.	3/0-#2	
83747-4	2/0 str.-2/0 str.	2/0-2/0	3/8 Clad or Galv.-2/0
	3/0 str.-1/0 str.	3/0-1/0	1/2 Clad or Galv.-#2
	4/0 str.-#2 sol., str.	4/0, 250-#2	
83749-1	3/0 str.-#2 str.	3/0-2/0	1/2 Clad or Galv.-1/0
	4/0 str.-1/0 str.	4/0-1/0	5/8 Clad - #2
	250 str.-#2 sol., str.	300-#2	
83749-2	3/0 str.-3/0, str.	3/0-3/0	1/2 Clad or Galv.-2/0
	4/0 str.-2/0 str.	4/0, 250-2/0	5/8 Clad-1/0
	250 str.-1/0 str.	250/300-1/0	5/8 Galv.-#2
	300 str.-#2 sol., str.	350-#2	
83749-3	4/0 str.-3/0 str.	4/0-3/0	1/2 Clad or Galv.-3/0
	250 str.-2/0 str.	300-2/0	5/8 Clad-2/0
	300 str.-1/0 str.	350-1/0	5/8 Galv.-1/0
	350 str.-#2 sol., str.	400, 450-#2	3/4 Clad-#2
83748-1	4/0 str.-4/0 str.	4/0-4/0	1/2 Clad or Galv.-4/0
	250 str.-3/0 str.	250, 300-3/0	5/8 Clad-3/0
	300 str.-2/0 str.	350-2/0	5/8 Galv.-2/0
	350 str.-1/0 str.	400-1/0	
83748-2	4/0 str.-4/0 str.	250, 300-4/0	5/8 Clad-4/0
	300 str.-3/0 str.	350-3/0	5/8 Galv.-3/0
	350 str.-2/0 str.	400-2/0	
83749-4	400, 450 str.-#2 sol., str.	450-1/0	3/4 Clad-1/0
		500-#2	3/4 Galv.-#2
83748-3	350 str.-3/0 str.	400-3/0	3/4 Clad-2/0
	400 str.-2/0, 1/0 str.	450-2/0	3/4 Galv.-1/0
	450 str.-1/0 str.	500-1/0	
83748-4	300 str.-4/0 str.	350-4/0, 250	5/8 Galv.-4/0
	400 str.-3/0 str.	400-4/0	5/8 Galv.-250 cmpt.
	450 str.-2/0 str.	450-3/0	3/4 Clad-3/0
		500 - 2/0	3/4 Galv.-2/0
83750-1	250 str.-250 str.	250, 300-250, 300	5/8 Clad-250 str., cmpt.
83751-1	300 str.-250 str.	350, 400-300	5/8 Galv.-250 str., 300 cmpt.
	350, 400 str.-4/0 str.	400-250	3/4 Clad-4/0, 250 cmpt.
	450 str.-3/0 str.	450-4/0	3/4 Galv.-3/0
	500 str. - 2/0 str.	500-3/0	
83751-2	300, 350 str.-300 str.	350, 400-350	5/8 Galv.-350 cmpt, 300 str.
	350, 400 str.-250 str.	450-300, 250	3/4 Clad-250 str., 300 cmpt.
	450 str.-4/0 str.	500-250	3/4 Galv.-4/0, 250 cmpt.
	500 str.-3/0 str.		
83751-3	350 str.-350 str.	400-400	3/4 Clad-300 str., 350 cmpt, str., 400 cmpt.
	400 str.-300 str.	450-350	3/4 Galv.-250 str., 300 cmpt.
	450 str.-250 str.	500-350, 300	
	500 str.-4/0 str.		
83751-4	400 str.-350 str.	400, 500-400	3/4 Galv.-300 str., 350 cmpt, 400 cmpt.
	450 str.-300 str.		
	500 str.-250 str.		
83750-2	400 str.-400 str.	450, 500-450	3/4 Galv.-350 str., 450 cmpt.
	450 str.-350 str.		
	500 str.-300 str.		
83750-3	450 str.-400 str.	500-500	3/4 Galv.-400 str., 500 cmpt.
	450 str.-400 str.		
	500 str.-350 str.		
83750-5	450 str.-450 str.		
	500 str.-400 str.		
83750-4	500 str.-450 str.		
83750-6	500 str.-500 str.		

WRENCH-LOK WIRE DIAMETER SYSTEMS: DIMENSIONS IN INCHES (MM)

IMPERIAL	Sum of Diameters		Large Wire		Small Wire	
	Max.	Min.	Max.	Min.	Max.	Min.
83747-1	0.595	0.500	0.296	0.204	0.296	0.204
83747-2	0.706	0.594	0.420	0.298	0.296	0.204
83747-3	0.782	0.672	0.470	0.302	0.370	0.258
83747-4	0.832	0.733	0.520	0.313	0.420	0.258
83749-1	0.89	0.799	0.630	0.423	0.470	0.258
83749-2	0.942	0.846	0.630	0.423	0.470	0.258
83749-3	1.003	0.898	0.700	0.470	0.470	0.258
83748-1	1.050	0.943	0.700	0.470	0.700	0.292
83748-2	1.099	0.995	0.700	0.470	0.522	0.295
83749-4	1.068	0.964	0.770	0.500	0.470	0.258
83748-3	1.146	1.042	0.770	0.500	0.520	0.292
83748-4	1.192	1.086	0.770	0.500	0.520	0.316
83750-1	1.148	1.04	0.580	0.460	0.580	0.460
83751-1	1.250	1.147	0.815	0.572	0.575	0.336
83751-2	1.311	1.212	0.815	0.582	0.630	0.414
83751-3	1.374	1.288	0.815	0.606	0.682	0.473
83751-4	1.419	1.342	0.815	0.660	0.682	0.527
83750-2	1.464	1.400	0.815	0.670	0.730	0.585
83750-3	1.510	1.446	0.815	0.676	0.770	0.631
83750-5	1.546	1.495	0.815	0.680	0.815	0.680
83750-4	1.580	1.538	0.815	0.723	0.815	0.723
83750-6	1.620	1.578	0.815	0.763	0.815	0.763

METRIC	Sum of Diameters		Large Wire		Small Wire	
	Max.	Min.	Max.	Min.	Max.	Min.
83747-1	15.113	12.700	7.518	5.182	7.518	5.182
83747-2	17.932	15.088	10.668	7.569	7.518	5.182
83747-3	19.863	17.069	11.938	7.671	9.398	6.553
83747-4	21.133	18.618	13.208	7.950	10.668	6.553
83749-1	22.606	20.295	16.002	10.744	11.938	6.553
83749-2	23.927	21.488	16.002	10.744	11.938	6.553
83749-3	25.476	22.809	17.780	11.938	11.938	6.553
83748-1	26.670	23.952	17.780	11.938	17.780	7.417
83748-2	27.910	25.273	17.780	11.938	13.259	7.493
83749-4	27.127	24.486	19.558	12.700	11.938	6.553
83748-3	29.108	26.467	19.558	12.700	13.208	7.417
83748-4	30.277	27.584	19.558	12.700	13.208	8.026
83750-1	29.159	26.416	14.732	11.684	14.732	11.684
83751-1	31.750	29.134	20.701	14.529	14.605	8.534
83751-2	33.299	30.785	20.701	14.783	16.002	10.516
83751-3	34.900	32.715	20.701	15.390	17.323	12.014
83751-4	36.043	34.087	20.701	16.764	17.323	13.386
83750-2	37.186	35.56	20.701	17.018	18.542	14.859
83750-3	38.354	36.728	20.701	17.170	19.558	16.027
83750-5	39.268	37.973	20.701	17.272	20.701	17.272
83750-4	40.132	39.065	20.701	18.364	20.701	18.364
83750-6	41.148	40.081	20.701	19.380	20.701	19.380

Universal Distribution Connectors

1

FEATURES

- Composed of a "C" component and a "Wedge" component, both made of a tin-plated copper alloy, in a configuration that creates a spring action.
- Can be rapidly and safely installed without special tools
- Conventional "parallel jaw" pliers are used to make the connection. A good connection can be easily verified by visual inspection.
- A wide range of connectors cover combinations of conductors ranging from 14 AWG to 4/0 AWG [1.5 mm² to 120 mm²], and all can be removed without damaging the conductors.

APPLICATIONS

- Recommended for connecting conductors of aluminum, copper, steel and their alloys regardless of the combination (i.e., Al to Al, Al to Cu, Cu to Cu) in normal corrosive environments.

BENEFITS

- Their technical design and construction are such that they have neither the disadvantages of some screw connectors, which must be periodically readjusted and retightened, nor the drawbacks of compression-type connectors, which are difficult to select and install, and which, once applied, cannot be removed without rendering the conductors useless.
- In addition to these technical features, the Universal Distribution Connector provides a noncorrosive connection that is protected against temperature variation and overloading.
- The reinforced version was developed to comply to ANSI C119.4 "Pull-Out" test and can be used in high cable tension applications. Both connector versions comply with all other specifications/ tests of ANSI C119.4 Standard.

Universal Distribution Connectors

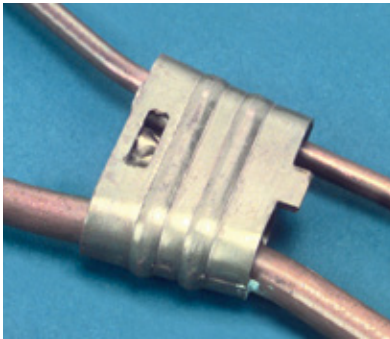

"C" component configuration before application

Double spring action exerted by the "C" and the "Wedge" components maintain a permanent contact force, providing a safe and efficient electrical connection

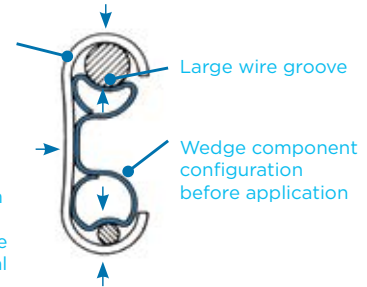

Residential/Commercial Grounding

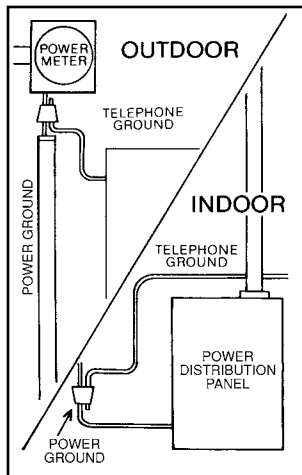

- Telephone grounding
- Street lights
- Service entrance drops
- Aerial connections

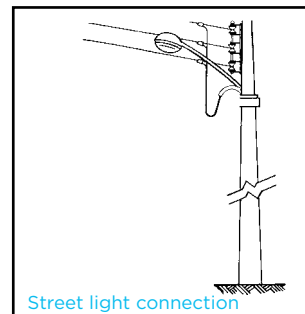
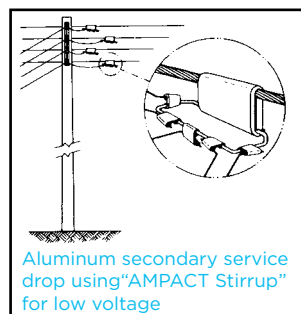
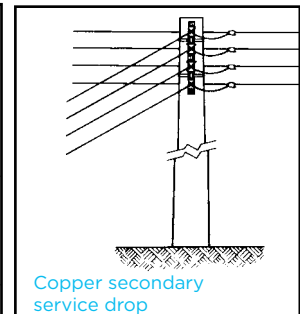
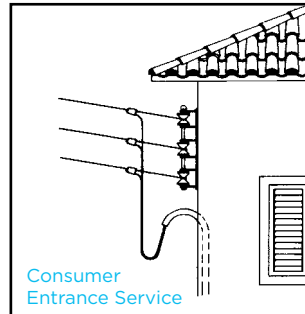
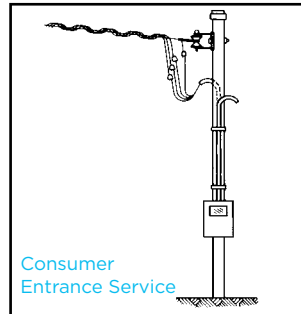

Technical Documents

Product Specifications 108-37019
Instruction Sheet 411-37014

DIMENSIONS IN INCHES (MM)

	Type	Top Groove		Bottom Groove		Sum		Package Color	Catalog No. (Reinforced)	Cover Catalog No.
		max.	min.	max.	min.	max.	min.			
Symmetrical Connectors	I	.320 (8,12)	.125 (3,17)	.275 (7,00)	.125 (3,17)	.551 (14,01)	.418 (10,60)	Gray	881781-1	881224-1
	II	.320 (8,12)	.125 (3,17)	.208 (5,30)	.125 (3,17)	.417 (10,59)	.347 (8,82)	Green	881783-1	881225-1
	III	.258 (6,55)	.100 (2,54)	.174 (4,41)	.050 (1,27)	.346 (8,81)	.291 (7,40)	Red	881785-1	881226-1
	IV	.241 (6,12)	.100 (2,54)	.145 (3,70)	.050 (1,27)	.290 (7,39)	.236 (5,99)	Blue	881787-1	881226-1
	V	.186 (4,72)	.100 (2,54)	.118 (3,00)	.050 (1,27)	.235 (5,98)	.180 (4,58)	Yellow	881789-1	881226-1
	VI	.417 (10,61)	.315 (8,01)	.368 (9,36)	.257 (6,54)	.737 (18,72)	.661 (16,79)	White/ Blue	444031-1	602061-0
	VII	.398 (10,11)	.183 (4,66)	.327 (8,30)	.183 (4,66)	.660 (16,78)	.552 (14,02)	White/ Red	444033-1	602061-0
	VIII	.398 (10,11)	.315 (8,01)	.398 (10,11)	.315 (8,01)	.796 (20,22)	.738 (18,73)	Green/ White	444385-1	602061-0
Asymmetrical Connectors	A	.368 (9,36)	.220 (5,60)	.201 (5,10)	.068 (1,74)	.431 (10,95)	.358 (9,10)	Violet	688652-1	688385-1
	B	.368 (9,36)	.244 (6,20)	.201 (5,10)	.068 (1,74)	.516 (13,11)	.431 (10,95)	Orange	688653-1	688385-1
	C	.501 (12,74)	.323 (8,20)	.201 (5,10)	.068 (1,74)	.581 (14,75)	.516 (13,11)	Brown	688654-1	688386-1
	D	.501 (12,74)	.374 (9,50)	.201 (5,10)	.068 (1,74)	.669 (17,00)	.581 (14,75)	White	688655-1	688386-1
	F	.328 (8,33)	.220 (5,60)	.201 (5,10)	.068 (1,74)	.358 (9,10)	.283 (7,20)	Green/ Blue	688656-1	688385-1
	G	.328 (8,33)	.220 (5,60)	.068 (1,73)	.054 (1,36)	.358 (9,10)	.283 (7,20)	Violet/ Blue	688657-1	688385-1

*Note: Universal Distribution Connectors are supplied in individual packages identified by Type.

Example

To make a service entrance of a 4 AWG [21 mm²] stranded Al cable to a 10 AWG [5.12 mm²] solid Cu wire, add:

Diameter of Main Wire (4 AWG [21 mm ²] stranded Al cable)	= 0.232 in. [5,89 mm]	}	The recommended connector is Type III, with the red color plastic bag.
Diameter of Service Entrance Wire (10 AWG [5.12 mm ²] solid Cu wire)	= 0.096 in. [2,44 mm]		
Total of Diameters	= 0.328 in. [8,33 mm]		

EXTRACTION TOOLS

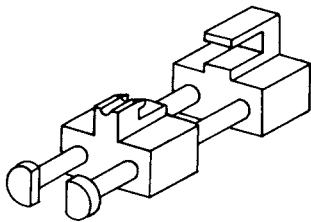

572882-1

IS 411-37014

(For use with Symmetrical Connectors)

SELECTION INFORMATION: SYMMETRICAL AND ASYMMETRICAL CONNECTORS (AWGX AWG)

Wire Size	SOLID						STR CU/AL AAC							STR ACSR							STR COMPRESSED									
	10	8	6	4	2	1/0	10	8	6	4	2	1/0	2/0	3/0	4/0	8	6	4	2	1/0	2/0	3/0	4/0	8	6	4	2	1/0		
SOLID	14	V	V	IV	III/G	A	V	V	IV	III/G	G	K	K		V	IV	III/G	H	K					V	IV	IV/G	G	H		
	12	V	V	IV	III/F	A	V	V	IV	III/F	A	B	J	C		IV	IV	III/F	A	J	C	D		V	IV	IV	A	B		
	10	V	V	IV	III	II/F	A	V	IV	IV	III/F	A	B	C	C		IV	III	F	A	J	C	D	L	IV	IV	III	A	B	
	8		IV	IV	III	II/A	B		IV	III	II/A	B	B	C	F	L	IV	III	II/A	I/B	C	C	D	L	IV	III	III	II/A	B	
	6			III	II	I/A	B			III	II/A	I/B	C	C	D			II	II/A	I/B	C	D	D	L		III	II	I/B	C	
	4				II	I					I	I	VII						I	I	VII							I	VII	
	2						I	VII				I	VII	VI						VII	VII	VI						I	VII	
1/0							VII					VI								VI								VI		
STR CU/AL AAC	14		V	IV	IV	III/F	A	V	V	IV	III/F	A	B	J	C		V	IV	III/F	A	J	C	C		V	IV	IV/F	A	B	
	12		V	V	IV	III	F	A	V	IV	IV	III/F	A	B	J	C		IV	IV	III/F	A	J	C	D	L	V	IV	III	A	B
	10		V	IV	IV	III	A	B	V	IV	III	F	A	B	C	D		IV	III	A	B	J	C	D	L	IV	III	III	A	B
	8			IV	III	II	II/A	B		III	III	II/A	I/B	B	C	D	L	III	III	II/A	I/B	VII/C	D	D	L	IV	III	II	I/A	B
	6				II	I/B	B			III	II/A	I/B	VII/C	D	D			II	I/B	I/B	VII/D	D	D	L			II	I/B	C	
	4					I	VII				I	I	VII						I	I	VI							I	VII	
	2							VII				VII	VII	VI						VII	VIII								VII	
1/0											VI																		VII	
STR ACSR	14					F	A			F	A	B	J					F	A	J							F	F	B	
	12					F	A			F	A	B	J	C					F	A	J	C	D	L			F	A	B	
	10					A	B			F	A	B	C	D					A	B	J	C	D	L			F	A	B	
	8			IV	III	III	II/A	B		IV	III	II/A	I/B	C	C	D	L	III	III	II/A	I/B	C	D	D	L	IV	III		I/A	B
	6				III	II	I/B	B		II	II/A	I/B	C	D	D	L		II	I/A	I/B	C	D	L	L		II	II/A	I/B	C	
	4					I	VII				I	I	VII						I	VII	VII							I	VII	
	2							VII				VII	VI							VII	VI								VII	
1/0											VI									VIII									VIII	
STR COMPRESSED	14					F	A			F	A	B	J					F	A	J							F	F	B	
	12					F	A			F	A	B	J	C					F	A	J	C	D	L			F	A	B	
	10					A	B			F	A	B	C	D					A	B	J	C	D	L			F	A	B	
	8			IV	III	III	II/A	B		IV	III	II/A	I/B	C	C	D	L	III	III	II/A	I/B	C	D	D	L	IV	III		I/A	B
	6				III	II	I/B	B		II	II/A	I/B	C	D	D	L		II	I/A	I/B	C	D	L	L		II	II/A	I/B	C	
	4					I	VII				I	I	VII						I	VII	VII							I	VII	
	2							VII				VII	VI							VII	VI								VII	
1/0											VI									VII									VI	

SELECTION INFORMATION: SYMMETRICAL AND ASYMMETRICAL CONNECTORS (AWGX MM2)

Wire Size	SOLID						STR CU/AL AAC							STR ACSR							STR COMPRESSED									
	10	8	6	4	2	1/0	10	8	6	4	2	1/0	2/0	3/0	8	6	4	2	1/0	2/0	3/0	8	6	4	2	1/0				
SOLID	1.5	V	V	IV	III/G	A	V	V	IV	IV/G	G	H	K		V	IV	III/G	H	K	H				V	IV	IV/G	G	H		
	2.5	V	V	IV	III/F	A	V	V	IV	III/F	A	B	J	C		V	IV	III/F	A	J	A	C		V	IV	III/F	F	A		
	4	V	V	IV	IV	III/F	A	IV	V	IV	III/F	A	B	J	C		IV	IV	III/F	A	J	A	D		V	IV	III/F	A	B	
	6		V	IV	III	A	A/B	IV	IV	IV	III/F	A	B	C	C		IV	III	F	A	J	A	D		IV	IV	III/F	A	B	
	10			III	III	IV/A	B	III	IV	III	II/A	I/A	B	C	D		III	III	IV/A	I/B	C	I	D		IV	III	A/II	I/A	B	
	16				II	I/A/B	B			II	II/A	I/B	C	D	D			II	I/A	I/B	C	I/B	D			II	A/II	I/B	C	
	25					I					I	I	VII						I	I	VII	I	L				I	I	VII	
35					H	VII					VII	VII	VI						VII	VI	VII					I	VII			
50						VII					VI	VI							VII	VI	VII							VI		
STR CU/AL AAC	1.5		V	IV	III/G	H	V	V	V	IV/G	G	H	K		V	IV	III/G	H	K					V	IV	IV/G	G	H		
	2.5		V	V	IV	III/F	A	V	V	V	III/F	A	B	J	C		IV	IV	III/F	A	J	C	C		V	IV	III/F	A	B	
	4		V	V	III	F	A	IV	IV	V	III/F	A	B	J	C		IV	III	F	A	J	C	D		IV	IV	III/F	A	B	
	6			IV	IV	III	A	B	IV	IV	IV	F	A	B	C	D		IV	III	A	B	C	C	D		IV	III	F	A	B
	10				III	II	II/A	B	III		III	II/A	1/B	C	C	D			II	II/A	I/B	C	D	D			III	II/A	B	C
	16					II	I				I	I	VII							I	I	VII						I	I/B	VII
	25						I	VII				I	VII								VII	VII						I	VII	
35							VII				VI	VI								VII	VI						I	VII		
50											VI										VIII								VI	

SELECTION INFORMATION: SYMMETRICAL AND ASYMMETRICAL CONNECTORS (MM2 X AWG)

Wire Size	SOLID						STR AAC							STR COMPRESSED								
S 14	6	10	16	25	35	50	4	6	10	16	25	35	50	70	90	10	16	25	35	50	70	95
O 12	V	V	IV	IV/G	G	H	V	V	IV	III/G	H	H	K	V	IV	III/G	G	H	K			
L 10	V	V	IV	III/F	F	A	V	V	IV	III/F	A	B	J	C	V	IV	III/F	F	A	J	C	
I 8	V	IV	IV	III/F	A	A	V	V	IV	III	F	A	B	J	D	IV	IV	III/F	A	A	J	C
D 6		IV	III	II/F	II/A	I/B		IV	III	II/A	I/A	B	C	D	IV	III	II/A	II/A	I/B	J	C	
4			III	II/A	I/A	IB			II	II/A	I/B	C	C	D		II	II/A	I/B	I	C	D	
2				I	I	I				I	I	VII			I	I	I	VII				
1/0					I	VII					VII	VII	VI				I	VII	VII			
14	V	V	IV	III/F	F	A	V	V	IV	III/F	A	B	J	C	V	IV	III/F	F	A	J	C	
S 12	V	V	IV	III/F	F	A	V	V	IV	III	III/F	A	B	J	C	IV	IV	III/F	A	A	J	C
T 10		IV	IV	III/F	A	A/B		IV	IV	III	A	A	B	C	D	IV	III	F	A	B	J	C
R 8			III	II/A	II/A	I/B			III	II	II/A	I/B	B	C	D	III	III	II/A	I/A	I/B	C	D
A 6				II/A	I/B	I/B				II	I/B	I/B	C	D	D		II	I/A	I/B	I/B	VII/C	D
A 4					I	I					I	I	VII			I	I	I	VII			
C 2						VII					VII	VII					VII	VI				
1/0																			VII	VI	VIII	

SELECTION INFORMATION: SYMMETRICAL AND ASYMMETRICAL CONNECTORS (MM2 X MM2)

Wire Size	SOLID						STR AAC							STR COMPRESSED								
1.5	6	10	16	25	35	50	6	10	16	25	35	50	70	95	10	16	25	35	50	70	95	
S 2.5	V	V	IV	IV/G	G	H	V	V	IV	III/G	G	H	K	V	IV	IV/G	G	H	K			
O 4	V	V	IV	IV/F	F	A	V	V	IV	III/F	A	A	J	C	V	IV	III/A	F	A	J		
L 6	V	IV	IV	III/F	A	A	V	IV	IV	III/F	A	B	J	C	V	IV	III/F	A	A	J	C	
I 16	V	IV	IV	III/F	A	A	V	IV	III	F	A	B	J	D	IV	III	III/F	A	A	J	C	
D 25		IV	III	II/A	II/A	I/B		III	III	II/A	I/B	B	C	D	IV	III	II/A	II/A	I/B	C	D	
35			I	II/A	I/B	I/B			II	I/A	I/B	C	D	D		II	II/A	I/B	I/B	C	D	
50				I	I	I				I	I	VII			I	I	I	VII				
					I	VII					VII	VII	IV				I	VII	VII			
						VII					VI	VI					VII	VI				
1.5	V	V	IV	III/G	G	H	V	V	IV	III/G	G	H	K	V	IV	III/G	G	H	K			
S 2.5	V	V	IV	III/F	F	A	V	IV	IV	III/F	A	B	J	C	V	IV	III/F	F	A	J	C	
T 4	V	IV	IV	III/F	A	A	V	IV	III	F	A	B	J	D	IV	IV	III/F	A	A	J	C	
R 6		IV	III	III/F	A	B	IV	IV	III	A	A	B	C	D	IV	III	F	A	B	J	C	
10			III	II/A	I/A	I/B			III	II	II/A	I/B	B	C	D		III	II/A	I/B	I/B	C	D
A 16				I	I	I				II	I	I	VII			I	I	I	VII			
C 25					I	VII					I	I	VII				I	VII	VII			
C 35						VII					VII	VII	VI					VII	VI			
50											VI	VI					VI	VI				
S 10			III	II/A	II/A	I/B		III	II	II/A	I/B	B	C	D	III	III	II/A	I/A	I/B	C	D	
T 16				II/A	I/B	I/B			II	I/B	I/B	C	D		II	I/A	I/B	I/B	VII/C	D		
R 25					I	I				I	I	VII			I	I	I	VII				
35						VII					VII	VII	VI				I	VII	VII			
C 50											VI	VI					VI	VI				
P 70																		VII	VI	VII		

AMPACT Taps

WHAT ARE AMPACT TAPS?

AMPACT taps consist of a wedge and tapered, spring "C" member. AMP Inhibitor, an oxide-inhibiting compound, is placed in the tap grooves at the factory. During installation, the wedge is driven into the C member at high velocity between the run and tap conductors. This spreads the C member and places a high retentive force on the conductors for a reliable, long-lived connection. A locking tab, formed by a lance on the tool, prevents the wedge from loosening once it has been driven into position, and also provides a positive visual means for inspection.

IMPORTANCE OF COLOR CODES

Color coding plays a vital role in the AMPACT tap system. When installing taps, always use color-coded shells to match each AMPACT tap.

For example:

RED-coded taps require RED shell
No. 69338-2

WHITE-coded taps require WHITE shell
No. 69338-5. BLUE-coded taps require BLUE shell
No. 69338-1. YELLOW-coded taps require YELLOW shell
No. 69338-4.

WARNING: Carefully read TE's AMP Customer Manual CM2106, packaged with the tool, before attempting to apply any taps.

APPROVALS

Both AMPACT tools (Small Tool No. 69437 and Large Tool No. 69611) have been tested and listed by Underwriters Laboratories, Inc. (UL) and have been certified by the

Canadian Standard Association (CSA). AMPACT taps that are UL Listed or CSA Certified are noted on the following pages. Note, that AMPACT taps also meet or exceed NEMA-ANSI* specifications. AMPACT connectors and tooling also have the approval of the Rural Electrification Administration (REA).

* National Electrical Manufacturers' Association - American National Standards Institute.

How to use the selection charts

Note that the example chart has the larger conductor listed in the upper half of each vertical column and the smaller one in the bottom half of the column. Any wire in the upper portion of a column can be connected to any wire in the lower half of that same column by using the recommended AMPACT tap listed at the bottom of that column.

To Use the Chart:

Carefully check the size and type of the two wires to be connected.

Example No. 1/0 stranded ACSR, standard round to No. 4 solid copper (Cu).

In the upper portion of the chart, locate ACSR standard round. From this point, move across the vertical columns (as indicated by the arrow) until you come to the 1/0 column.











In the lower half of this 1/0 column, you will find "No. 4,5,6 solid: Al or Cu." The proper AMPACT tap number and color will appear at the bottom of this column. "USE AMPACT TAP No. 600528, COLOR RED."

AMPACT Aluminum Taps (Red, Blue, and Yellow Coded)











All AMPACT taps in this section are made from aluminum alloys that are corrosion resistant and highly conductive. They are used primarily to connect solid or stranded conductors including AAC, AAAC, ACSR, ACAR, AW, and ASCR/AW. They can also be used in non-corrosive environments to connect to copper conductors. In short, all aluminum taps listed in this section are used for connecting the following conductor combinations:

- Aluminum to Aluminum
- Aluminum to Copper
- Copper to Copper (in non-corrosive environments)

Individual tap packages are imprinted with applicable conductor combinations. Packages and labels are color-coded for ease in matching taps with proper tool and cartridge combinations.

S T R A N D E D	Large Wire Groove Code	U	R	Y	S	P	U	
	ACSR Standard Round		8 6/1	6 6/1	4 6/1, 7/1, 5 6/1	2 6/1, 7/1, 3 6/1	1/0, 1 6/1	8 6/1
	AAAC 6201-5005		–	6	4, 5	2, 3	1/0, 1	–
	AAC Standard Round		8	6	4, 5	2, 3	1/0, 1	8
	COPPER Standard Round		8	6	4, 5	2, 3	1/0, 1	8
	AAC Compressed or Compacted		8	6	3, 4	1, 2	1/0	8
	ACSR Compressed or Compacted		–	6 6/1	4 6/1, 7/1	26/1, 7/1	1/0, 1 6/1	–
	AWAC, ACAR		–	–	4 6/1	4 5/2, 4/3, 3/4, 3 6/1, 5/2, 4/3, 2 6/1	4 2/5, 3 3/4, 2/5, 2 5/2, 4/3, 3/4, 1 6/1, 5/2, 4/3, 1/0 6/1	–
	ALUMOWELD COPPERWELD		–	8A, 8C 3 No. 12	6A, 6C, 7A, 7D, 8D 3 No. 9, 3 No. 10, 7 No. 12	2F, 4A, 5A, 5D, 6D, 3 No. 7, 7 No. 10, 3 No. 8, 7 No. 11	1/0F, 1F, 1G, 1J, 2A, 2G, 2J, 2K, 3A, 4D, 4N, 4P, 3 No. 5, 7 No. 8, 3 No. 6, 7 No. 9	–
	Galvanized Steel		5/32"	3/16"	7/32", 1/4"	9/32", 5/16"	11/32", 3/8"	5/32"
Solid: AL or CU		8	5, 6	3, 4	1, 2	1/0	6, 8	













S T R A N D E D	ACSR Standard Round		–	–	–	–	–	8 6/1
	AAAC 6201-5005		–	–	–	–	–	–
	AAC Standard Round		10, 12, 14	10, 12, 14	10, 12, 14	10, 12, 14	10, 12, 14	8
	COPPER Standard Round		10, 12, 14	10, 12, 14	10, 12, 14	10, 12, 14	10, 12, 14	8
	AAC Compressed or Compacted		–	–	–	–	–	8
	ACSR Compressed or Compacted		–	–	–	–	–	–
	AWAC, ACAR		–	–	–	–	–	–
	ALUMOWELD COPPERWELD		–	–	–	–	–	–
	Galvanized Steel		–	–	–	–	–	5/32"
	Solid: AL or CU		10, 12, 14	10, 12, 14	10, 12, 1	10, 12, 14	10, 12, 14	6, 8









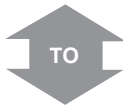
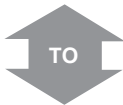
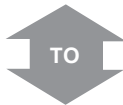
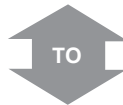
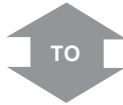

Use TAP Number 602302-4 602302-3 602302-2 602302-1 602302 600532*

Red coded taps are not sold in North America and should be substituted with white coded taps shown on the following pages.

*UL Listed

S T R A N D E D	Large Wire Groove Code	X	R	X	R	S	Y	
	ACSR Standard Round		6 6/1	6 6/1	4 6/1, 7/1, 5 6/1	4 6/1, 7/1, 5 6/1	4 6/1, 7/1, 5 6/1	2 6/1, 7/1, 3 6/1
	AAAC 6201-5005		6	6	4, 5	4, 5	4, 5	2, 3
	AAC Standard Round		6	6	4, 5	4, 5	4, 5	2, 3
	COPPER Standard Round		6	6	4, 5	4, 5	4, 5	2, 3
	AAC Compressed or Compacted		6	6	3, 4	3, 4	3, 4	1, 2
	ACSR Compressed or Compacted		6 6/1	6 6/1	4 6/1, 7/1	4 6/1, 7/1	4 6/1, 7/1	2 6/1, 7/1
	AWAC, ACAR		—	—	4 6/1	4 6/1	4 6/1	4 5/2, 4/3, 3/4, 3 6/1, 5/2, 4/3, 2 6/1
	ALUMOWELD COPPERWELD		8A, 8C 3 No. 12	8A, 8C 3 No. 12	6A, 6C, 7A, 7D, 8D, 3 No. 9, 3 No. 10, 7 No. 12	6A, 6C, 7A, 7D, 8D, 3 No. 9, 7 No. 12, 3 No. 10	6A, 6C, 7A, 7D, 8D, 3 No. 9, 7 No. 12, 3 No. 10	2F, 4A, 5A, 5D, 6D, 3 No. 7, 7 No. 10, 3 No. 8, 7 No. 11
	Galvanized Steel		3/16"	3/16"	7/32", 1/4"	7/32", 1/4"	7/32", 1/4"	9/32", 5/16"
Solid: AL or CU		4, 5	4, 5	2, 3	2, 3	2, 3	—	



S T R A N D E D	ACSR Standard Round		8 6/1	6 6/1	8 6/1	6 6/1	4 6/1, 7/1, 5 6/1	8 6/1
	AAAC 6201-5005		—	6	—	6	4, 5	—
	AAC Standard Round		8	6	8	6	4, 5	8
	COPPER Standard Round		8	6	8	6	4, 5	8
	AAC Compressed or Compacted		8	6	8	6	3, 4	8
	ACSR Compressed or Compacted		—	6 6/1	—	6 6/1	4 6/1, 7/1	—
	AWAC, ACAR		—	—	—	—	4 6/1	—
	ALUMOWELD COPPERWELD		—	8A, 8C 3 No. 12	—	8A, 8C, 3 No. 12	6A, 6C, 7A, 7D, 8D, 3 No. 9, 3 No. 10, 7 No. 12	—
	Galvanized Steel		5/32"	3/16"	5/32"	3/16"	7/32", 1/4"	5/32"
	Solid: AL or CU		8	4, 5, 6	8	5, 6	3, 4	6, 8

Use TAP Number

600535*

600530*

600535*











600530*

600531*









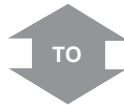
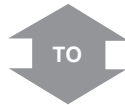
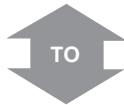
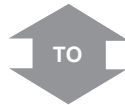
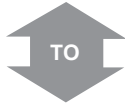

600534*

Red coded taps are not sold in North America and should be substituted with white coded taps shown on the following pages.

*UL Listed

S T R A N D E D	Large Wire Groove Code	S	P	Q	W
	ACSR Standard Round	 2 6/1, 7/1, 3 6/1	2 6/1, 7/1, 3 6/1	2 6/1, 7/1, 3 6/1	1/0, 1 6/1
	AAAC 6201-5005	 2, 3	2, 3	2, 3	1/0, 1
	AAC Standard Round	 2, 3	2, 3	2, 3	1/0, 1
	COPPER Standard Round	 2, 3	2, 3	2, 3	1/0, 1
	AAC Compressed or Compacted	 1, 2	1, 2	1, 2	1/0
	ACSR Compressed or Compacted	 2 6/1, 7/1	2 6/1, 7/1	2 6/1, 7/1	1/0, 1 6/1
	AWAC, ACAR	 4 5/2, 4/3, 3/4, 3 6/1, 5/2, 4/3, 2 6/1	4 5/2, 4/3, 3/4, 3 6/1, 5/2, 4/3, 2 6/1	4 5/2, 4/3, 3/4, 3 6/1, 5/2, 4/3, 2 6/1	4 2/5, 3 3/4, 2/5, 2 5/2, 4/3, 3/4, 1 6/1, 5/2, 4/3, 1/0 6/1
	ALUMOWELD COPPERWELD	 2F, 4A, 5A, 5D, 6D, 3 No. 7, 7 No. 10, 3 No. 8, 7 No. 11	2F, 4A, 5A, 5D, 6D, 3 No. 7, 7 No. 10, 3 No. 8, 7 No. 11	2F, 4A, 5A, 5D, 6D, 3 No. 7, 7 No. 10, 3 No. 8, 7 No. 11	1/0F, 1F, 1G, 1J, 2A, 2G, 2J, 2K, 3A, 4D, 4N, 4P, 3 No. 5, 7 No. 8, 3 No. 6, 7 No. 9
	Galvanized Steel	 9/32", 5/16"	9/32", 5/16"	9/32", 5/16"	11/32", 3/8"
Solid: AL or CU	 1	1, 2	1/0, 1	1/0	



S T R A N D E D	ACSR Standard Round	 6 6/1	4 6/1, 7/1, 5 6/1	2 6/1, 7/1, 3 6/1	8 6/1
	AAAC 6201-5005	 6	4, 5	2, 3	–
	AAC Standard Round	 6	4, 5	2, 3	8
	COPPER Standard Round	 6	4, 5	2, 3	8
	AAC Compressed or Compacted	 6	3, 4	1, 2	8
	ACSR Compressed or Compacted	 6 6/1	4 6/1, 7/1	2 6/1, 7/1	–
	AWAC, ACAR	 –	4 6/1	4 5/2, 4/3, 3/4, 3 6/1, 5/2, 4/3, 2 6/1	–
	ALUMOWELD COPPERWELD	 8A, 8C 3 No. 12	6A, 6C, 7A, 7D, 8D, 3 No. 9, 3 No. 10, 7 No. 12	2F, 4A, 5A, 5D, 6D, 3 No. 7, 7 No. 10, 3 No. 8, 7 No. 11	–
	Galvanized Steel	 3/16"	7/32", 1/4"	9/32", 5/16"	5/32"
	Solid: AL or CU	 4, 5, 6	2, 3	1, 2	6, 8

Use TAP Number

600531*











600528*

600529*









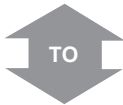
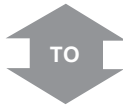
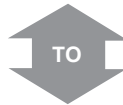
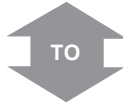

600533*

Red coded taps are not sold in North America and should be substituted with white coded taps shown on the following pages.

*UL Listed

Large Wire Groove Code		P	Q	N
S T R A N D E D	ACSR Standard Round 	1/0, 1 6/1	1/0, 1 6/1	1/0, 1 6/1
	AAAC 6201-5005 	1/0, 1	1/0, 1	1/0, 1
	AAC Standard Round 	1/0, 1	1/0, 1	1/0, 1
	COPPER Standard Round 	1/0, 1	1/0, 1	1/0, 1
	AAC Compressed or Compacted 	1/0	1/0	1/0
	ACSR Compressed or Compacted 	1/0, 1 6/1	1/0, 1 6/1	1/0, 1 6/1
	AWAC, ACAR 	4 2/5, 3 3/4, 2/5, 2 5/2, 4/3, 3/4, 1 6/1, 5/2, 4/3, 1/0 6/1	4 2/5, 3 3/4, 2/5, 2 5/2, 4/3, 3/4, 1 6/1, 5/2, 4/3, 1/0 6/1	4 2/5, 3 3/4, 2/5, 2 5/2, 4/3, 3/4, 1 6/1, 5/2, 4/3, 1/0 6/1
	ALUMOWELD COPPERWELD 	1/0F, 1F, 1G, 1J, 2A, 2G, 2J, 2K, 3A, 4D, 4N, 4P, 3 No. 5, 7 No. 8, 3 No. 6, 7 No. 9	1/0F, 1F, 1G, 1J, 2A, 2G, 2J, 2K, 3A, 4D, 4N, 4P, 3 No. 5, 7 No. 8, 3 No. 6, 7 No. 9	1/0F, 1F, 1G, 1J, 2A, 2G, 2J, 2K, 3A, 4D, 4N, 4P, 3 No. 5, 7 No. 8, 3 No. 6, 7 No. 9
	Galvanized Steel 	11/32", 3/8"	11/32", 3/8"	11/32", 3/8"
Solid: AL or CU 	1/0	1/0	1/0	



S T R A N D E D	ACSR Standard Round 	6 6/1	4 6/1, 7/1, 5 6/1	2 6/1, 7/1, 3 6/1
	AAAC 6201-5005 	6	4, 5	2, 3
	AAC Standard Round 	6	4, 5	2, 3
	COPPER Standard Round 	6	4, 5	2, 3
	AAC Compressed or Compacted 	6	3, 4	1, 2
	ACSR Compressed or Compacted 	6 6/1	4 6/1, 7/1	2 6/1, 7/1
	AWAC, ACAR 	—	4 6/1	4 5/2, 4/3, 3/4, 3 6/1, 5/2, 4/3, 2 6/1
	ALUMOWELD COPPERWELD 	8A, 8C 3 No. 12	6A, 6C, 7A, 7D, 8D, 3 No. 9, 3 No. 10, 7 No. 12	2F, 4A, 5A, 5D, 6D, 3 No. 7, 7 No. 10, 3 No. 8, 7 No. 11
	Galvanized Steel 	3/16"	7/32", 1/4"	9/32", 5/16"
Solid: AL or CU 	4, 5, 6	2, 3	1	

Use TAP Number











600528*

600529*









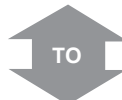
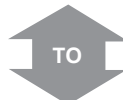
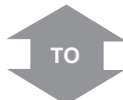
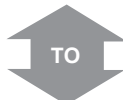

600525

Red coded taps are not sold in North America and should be substituted with white coded taps shown on the following pages.

*UL Listed

S T R A N S M I T T E R	Large Wire Groove Code	U	X	R	X	R	S	
	ACSR Standard Round		8 6/1	6 6/1	6 6/1	4 6/1, 7/1, 5 6/1	4 6/1, 7/1, 5 6/1	4 6/1, 7/1, 5 6/1
	AAAC 6201-5005		–	6	6	4, 5	4, 5	4, 5
	AAC Standard Round		8	6	6	4, 5	4, 5	4, 5
	COPPER Standard Round		8	6	6	4, 5	4, 5	4, 5
	AAC Compressed or Compacted		8	6	6	3, 4	3, 4	3, 4
	ACSR Compressed or Compacted		–	6 6/1	6 6/1	4 6/1, 7/1	4 6/1, 7/1	4 6/1, 7/1
	AWAC, ACAR		–	–	–	4 6/1	4 6/1	4 6/1
	ALUMOWELD COPPERWELD		–	8A, 8C, 3 No. 12	8A, 8C, 3 No. 12	6A, 6C, 7A, 7D, 8D, 3 No. 9, 3 No. 10, 7 No. 12	6A, 6C, 7A, 7D, 8D, 3 No. 9, 3 No. 10, 7 No. 12	6A, 6C, 7A, 7D, 8D, 3 No. 9, 3 No. 10, 7 No. 12
	Galvanized Steel		5/32"	3/16"	3/16"	7/32", 1/4"	7/32", 1/4"	7/32", 1/4"
Solid: AL or CU		6, 8	4, 5	4, 5	2, 3	2, 3	2, 3	



S T R A N S M I T T E R	ACSR Standard Round		8 6/1	8 6/1	6 6/1	8 6/1	6 6/1	4 6/1, 7/1, 5 6/1
	AAAC 6201-5005		–	–	6	–	6	4, 5
	AAC Standard Round		8	8	6	8	6	4, 5
	COPPER Standard Round		8	8	6	8	6	4, 5
	AAC Compressed or Compacted		8	8	6	8	6	3, 4
	ACSR Compressed or Compacted		–	–	6 6/1	–	6 6/1	4 6/1, 7/1
	AWAC, ACAR		–	–	–	–	–	4 6/1
	ALUMOWELD COPPERWELD		–	–	8A, 8C 3 No. 12	–	8A, 8C 3 No. 12	6A, 6C, 7A, 7D, 8D, 3 No. 9, 7 No. 12, 3 No. 10,
	Galvanized Steel		5/32"	5/32"	3/16"	5/32"	3/16"	7/32", 1/4"
	Solid: AL or CU		6, 8	8	4, 5, 6	8	5, 6	3, 4

Use TAP Number

602283-5*

602283-8

602283-4*











602283-8

602283-4*









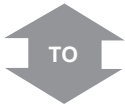
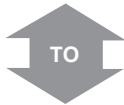
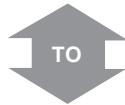
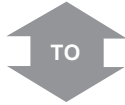

602283-3*

White - Coded Type II Aluminum Taps - Aluminum to Aluminum, Aluminum to Copper, Copper to Copper
(in non-corrosive environments)

*UL Listed

S T R A N D E D	Large Wire Groove Code	Y	S	P	Q	W	
	ACSR Standard Round	 2 6/1, 7/1, 3 6/1	2 6/1, 7/1, 3 6/1	2 6/1, 7/1, 3 6/1	2 6/1, 7/1, 3 6/1	2 6/1, 7/1, 3 6/1	1/0, 1 6/1
	AAAC 6201-5005	 2, 3	2, 3	2, 3	2, 3	2, 3	1/0, 1
	AAC Standard Round	 2, 3	2, 3	2, 3	2, 3	2, 3	1/0, 1
	COPPER Standard Round	 2, 3	2, 3	2, 3	2, 3	2, 3	1/0, 1
	AAC Compressed or Compacted	 1, 2	1, 2	1, 2	1, 2	1, 2	1/0
	ACSR Compressed or Compacted	 2 6/1, 7/1	2 6/1, 7/1	2 6/1, 7/1	2 6/1, 7/1	2 6/1, 7/1	1/0, 1 6/1
	AWAC, ACAR	 4 5/2, 4/3, 3/4, 3 6/1, 5/2, 4/3, 2 6/1	4 5/2, 4/3, 3/4, 3 6/1, 5/2, 4/3, 2 6/1	4 5/2, 4/3, 3/4, 3 6/1, 5/2, 4/3, 2 6/1	4 5/2, 4/3, 3/4, 3 6/1, 5/2, 4/3, 2 6/1	4 5/2, 4/3, 3/4, 3 6/1, 5/2, 4/3, 2 6/1	4 2/5, 3 3/4, 2/5, 2 5/2, 4/3, 3/4, 1 6/1, 5/2, 4/3, 1/0 6/1
	ALUMOWELD COPPERWELD	 2F, 4A, 5A, 5D, 6D, 3 No. 7, 7 No. 10, 3 No. 8, 7 No. 11	2F, 4A, 5A, 5D, 6D, 3 No. 7, 7 No. 10, 3 No. 8, 7 No. 11	2F, 4A, 5A, 5D, 6D, 3 No. 7, 7 No. 10, 3 No. 8, 7 No. 11	2F, 4A, 5A, 5D, 6D, 3 No. 7, 3 No. 8, 7 No. 10, 7 No. 11	2F, 4A, 5A, 5D, 6D, 3 No. 7, 3 No. 8, 7 No. 10, 7 No. 11	1/0F, 1F, 1G, 1J, 2A, 2G, 2J, 2K, 3A, 4D, 4N, 4P, 3 No. 5, 3 No. 6, 7 No. 8, 7 No. 9
	Galvanized Steel	 9/32", 5/16"	9/32", 5/16"	9/32", 5/16"	9/32", 5/16"	9/32", 5/16"	11/32", 3/8"
Solid: AL or CU	 1	1	1	1, 2	1/0, 1	1/0	













S T R A N D E D	ACSR Standard Round	 8 6/1	6 6/1	4 6/1, 7/1, 5 6/1	2 6/1, 7/1, 3 6/1	8 6/1
	AAAC 6201-5005	 -	6	4, 5	2, 3	-
	AAC Standard Round	 8	6	4, 5	2, 3	8
	COPPER Standard Round	 8	6	4, 5	2, 3	8
	AAC Compressed or Compacted	 8	6	3, 4	1, 2	8
	ACSR Compressed or Compacted	 -	6 6/1	4 6/1, 7/1	2 6/1, 7/1	-
	AWAC, ACAR	 -	-	4 6/1	4 5/2, 4/3, 3/4, 3 6/1, 5/2, 4/3, 2 6/1	-
	ALUMOWELD COPPERWELD	 -	8A, 8C 3 No. 12	6A, 6C, 7A, 7D, 8D, 3 No. 9, 3 No. 10, 7 No. 12	2F, 4A, 5A, 5D, 6D, 3 No. 7, 7 No. 10, 3 No. 8, 7 No. 11	-
	Galvanized Steel	 5/32"	3/16"	7/32", 1/4"	9/32", 5/16"	5/32"
	Solid: AL or CU	 6, 8	4, 5, 6	2, 3	1, 2	6, 8









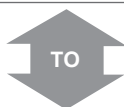
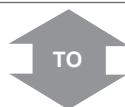
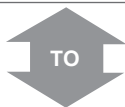

Use TAP Number **602283-7** **602283-3*** **602283-2*** **602283-1*** **602283-6**

White - Coded Type II Aluminum Taps - Aluminum to Aluminum, Aluminum to Copper, Copper to Copper
(in non-corrosive environments)

*UL Listed

Large Wire Groove Code		P	Q	N
S T R A N D E D	ACSR Standard Round 	1/0, 1 6/1	1/0, 1 6/1	1/0, 1 6/1, 2 6/1, 7/1
	AAAC 6201-5005 	1/0, 1	1/0, 1	1/0, 1
	AAC Standard Round 	1/0, 1	1/0, 1	1/0, 1
	COPPER Standard Round 	1/0, 1	1/0, 1	1/0, 1
	AAC Compressed or Compacted 	1/0, 1	1/0	1/0
	ACSR Compressed or Compacted 	1/0	1/0, 1 6/1	1/0, 1 6/1
	AWAC, ACAR 	4 2/5, 3 3/4, 2/5, 2 5/2, 4/3, 3/4, 1 6/1, 5/2, 4/3, 1/0 6/1	4 2/5, 3 3/4, 2/5, 2 5/2, 4/3, 3/4, 1 6/1, 5/2, 4/3, 1/0 6/1	4 2/5, 3 3/4, 2/5, 2 5/2, 4/3, 3/4, 1 6/1, 5/2, 4/3, 1/0 6/1
	ALUMOWELD COPPERWELD 	1/0F, 1F, 1G, 1J, 2A, 2G, 2J, 2K, 3A, 4D, 4N, 4P, 3 No. 5, 7 No. 8, 3 No. 6, 7 No. 9	1/0F, 1F, 1G, 1J, 2A, 2G, 2J, 2K, 3A, 4D, 4N, 4P, 3 No. 5, 7 No. 8, 3 No. 6, 7 No. 9	1/0F, 1F, 1G, 1J, 2A, 2G, 2J, 2K, 3A, 4D, 4N, 4P, 3 No. 5, 7 No. 8, 3 No. 6, 7 No. 9
	Galvanized Steel 	11/32", 3/8"	11/32", 3/8"	11/32", 3/8"
Solid: AL or CU 	1/0	1/0	-	



S T R A N D E D	ACSR Standard Round 	6 6/1	4 6/1, 7/1, 5 6/1	2 6/1, 7/1, 3 6/1
	AAAC 6201-5005 	6	4, 5	2, 3
	AAC Standard Round 	6	4, 5	2, 3
	COPPER Standard Round 	6	4, 5	2, 3
	AAC Compressed or Compacted 	6	3, 4	1, 2
	ACSR Compressed or Compacted 	6 6/1	4 6/1, 7/1	2 6/1, 7/1
	AWAC, ACAR 	-	4 6/1	4 5/2, 4/3, 3/4, 3 6/1, 5/2, 4/3, 2 6/1
	ALUMOWELD COPPERWELD 	8A, 8C 3 No. 12	6A, 6C, 7A, 7D, 8D, 3 No. 9, 3 No. 10, 7 No. 12	2F, 4A, 5A, 5D, 6D, 3 No. 7, 3 No. 8, 7 No. 10, 7 No. 11
	Galvanized Steel 	3/16"	7/32", 1/4"	9/32", 5/16"
Solid: AL or CU 	4, 5, 6	2, 3	1	

Use TAP Number











602283-2*

602283-1*











602283*

White - Coded Type II Aluminum Taps - Aluminum to Aluminum, Aluminum to Copper, Copper to Copper (in non-corrosive environments)

*UL Listed

S T R A N D E D	Large Wire Groove Code	A	C	D	A	E	T	
	ACSR Standard Round 	1/0, 1 6/1 2 6/1, 7/1	2/0, 1/0 6/1	2/0, 1/0 6/1	2/0, 1/0 6/1	2/0, 1/0 6/1	2/0, 1/0 6/1	2/0, 1/0 6/1
	AAAC 6201-5005 	1/0, 1, 2	2/0, 1/0	2/0, 1/0	2/0, 1/0	2/0, 1/0	2/0, 1/0	2/0, 1/0
	AAC Standard Round 	1/0, 1	2/0	2/0	2/0	2/0	2/0	2/0
	COPPER Standard Round 	1/0, 1	2/0	2/0	2/0	2/0	2/0	2/0
	AAC Compressed or Compacted 	1/0	2/0	2/0	2/0	2/0	2/0	2/0
	ACSR Compressed or Compacted 	1/0, 1 6/1	2/0 6/1	2/0 6/1	2/0 6/1	2/0 6/1	2/0 6/1	2/0 6/1
	AWAC, ACAR 	4 2/5, 3/4, 3 4/3, 3/4, 2/5, 2 6/1, 5/2, 4/3, 3/4, 1 6/1, 5/2, 4/3, 1/0 6/1	2 2/5, 1 3/4, 1/0 5/2, 4/3, 2/0 6/1	2 2/5, 1 3/4, 1/0 5/2, 4/3, 2/0 6/1	2 2/5, 1 3/4, 1/0 5/2, 4/3, 2/0 6/1	2 2/5, 1 3/4, 1/0 5/2, 4/3, 2/0 6/1	2 2/5, 1 3/4, 1/0 5/2, 4/3, 2/0 6/1	2 2/5, 1 3/4, 1/0 5/2, 4/3, 2/0 6/1
	ALUMOWELD COPPERWELD 	1/0F, 1F, 1G, 1J, 2A, 2F, 2G, 2J, 2K, 3A, 4D, 4N, 4P, 5D, 3 No. 5, 3 No. 6, 3 No. 7; 7 No. 8, 7 No. 9, 7 No. 10	2/0F, 1/0G, 1/0J, 1K, 2N, 7 No. 7	2/0F, 1/0G, 1/0J, 1K, 2N, 7 No. 7	2/0F, 1/0G, 1/0J, 1K, 2N, 7 No. 7	2/0F, 1/0G, 1/0J, 1K, 2N, 7 No. 7	2/0F, 1/0G, 1/0J, 1K, 2N, 7 No. 7	2/0F, 1/0G, 1/0J, 1K, 2N, 7 No. 7
	Galvanized Steel 	5/16", 11/32", 3/8"	7/16"	7/16"	7/16"	7/16"	7/16"	7/16"
Solid: AL or CU 	2/0, 1/0	3/0	3/0	3/0, 2/0	3/0, 2/0	3/0, 2/0	3/0, 2/0	













ACSR Standard Round 	1/0, 1 6/1 2 6/1, 7/1	6 6/1	4 6/1, 7/1, 5 6/1	2 6/1, 7/1, 3 6/1	1/0, 1 6/1	2/0 6/1
AAAC 6201-5005 	1, 2	6, 5	4	2, 3	1/0, 1	2/0
AAC Standard Round 	1/0, 1	6, 5	4	2, 3	1/0, 1	2/0
COPPER Standard Round 	1/0, 1	6, 5	4	2, 3	1/0, 1	2/0
AAC Compressed or Compacted 	1/0	6	3, 4	1, 2	1/0	2/0
ACSR Compressed or Compacted 	1/0, 1 6/1	6 6/1	4 6/1, 7/1	2 6/1, 7/1	1/0, 1 6/1	2/0 6/1
AWAC, ACAR 	4 2/5, 3/4, 3 4/3, 3/4, 2/5, 2 6/1, 5/2, 4/3, 3/4, 1 6/1, 5/2, 4/3, 1/0 6/1	—	4 6/1	4 5/2, 4/3, 3/4, 3 6/1, 5/2, 4/3, 2 6/1	4 2/5, 3/4, 3 4/3, 3/4, 2/5, 2 6/1, 5/2, 4/3, 3/4, 1 6/1, 5/2, 4/3, 1/0 6/1	2 2/5, 1 3/4, 1/0 5/2, 4/3, 2/0 6/1
ALUMOWELD COPPERWELD 	1/0F, 1F, 1G, 1J, 2A, 2F, 2G, 2J, 2K, 3A, 4D, 4N, 4P, 5D, 3 No. 5, 3 No. 6, 3 No. 7; 7 No. 8, 7 No. 9, 7 No. 10	8A, 8C, 3 No. 12	6A, 6C, 7A, 7D, 8D, 3 No. 9, 3 No. 10, 7 No. 12	2F, 4A, 5A, 5D, 6D, 3 No. 7, 3 No. 8, 7 No. 10, 7 No. 11	1/0F, 1F, 1G, 1J, 2A, 2G, 2J, 2K, 3A, 4D, 4N, 4P, 3 No. 5, 3 No. 6, 7 No. 8, 7 No. 9	2/0F, 1/0G, 1/0J, 1K, 2N, 7 No. 7
Galvanized Steel 	5/16", 11/32", 3/8"	3/16"	7/32", 1/4"	9/32", 5/16"	11/32", 3/8"	7/16"
Solid: AL or CU 	1/0	4, 5, 6	2, 3	1/0, 1, 2	2/0	3/0









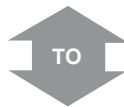
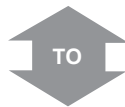
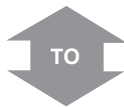
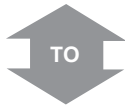

Use TAP Number 600403* 600446* 600447* 600403* 600448 600411*

*UL Listed



S T R A N D E D	Large Wire Groove Code	C	D	E	T	K	H	
	ACSR Standard Round	 3/0 6/1	3/0 6/1	3/0 6/1	3/0 6/1	3/0 6/1	3/0 6/1	3/0 6/1
	AAAC 6201-5005	 3/0	3/0	3/0	3/0	3/0	3/0	3/0
	AAC Standard Round	 3/0	3/0	3/0	3/0	3/0	3/0	3/0
	COPPER Standard Round	 3/0	3/0	3/0	3/0	3/0	3/0	3/0
	AAC Compressed or Compacted	 3/0	3/0	3/0	3/0	3/0	3/0	3/0
	ACSR Compressed or Compacted	 3/0 6/1	3/0 6/1	3/0 6/1	3/0 6/1	3/0 6/1	3/0 6/1	3/0 6/1
	AWAC, ACAR	 1 2/5, 1/0 3/4, 2/0 5/2, 4/3, 3/0 6/1	1 2/5, 1/0 3/4, 2/0 5/2, 4/3, 3/0 6/1	1 2/5, 1/0 3/4, 2/0 5/2, 4/3, 3/0 6/1	1 2/5, 1/0 3/4, 2/0 5/2, 4/3, 3/0 6/1	1 2/5, 1/0 3/4, 2/0 5/2, 4/3, 3/0 6/1	1 2/5, 1/0 3/4, 2/0 5/2, 4/3, 3/0 6/1	1 2/5, 1/0 3/4, 2/0 5/2, 4/3, 3/0 6/1
	ALUMOWELD COPPERWELD	 3/0F, 2/0G, 2/0J, 1/0F, 1N, 2P, 7 No. 6	3/0F, 2/0G, 2/0J, 1/0F, 1N, 2P, 7 No. 6	3/0F, 2/0G, 2/0J, 1/0F, 1N, 2P, 7 No. 6	3/0F, 2/0G, 2/0J, 1/0F, 1N, 2P, 7 No. 6	3/0F, 2/0G, 2/0J, 1/0F, 1N, 2P, 7 No. 6	3/0F, 2/0G, 2/0J, 1/0F, 1N, 2P, 7 No. 6	3/0F, 2/0G, 2/0J, 1/0F, 1N, 2P, 7 No. 6
	Galvanized Steel	 1/2"	1/2"	1/2"	1/2"	1/2"	1/2"	1/2"
Solid: AL or CU	 4/0	4/0	4/0	4/0	4/0	4/0	4/0	



ACSR Standard Round	 6 6/1	4 6/1, 7/1, 5 6/1	2 6/1, 7/1, 3 6/1	1/0, 1 6/1	2/0 6/1	3/0 6/1
AAAC 6201-5005	 6	4, 5	2, 3	1/0, 1	2/0	3/0
AAC Standard Round	 6	4, 5	2, 3	1/0, 1	2/0	3/0
COPPER Standard Round	 6	4, 5	2, 3	1/0, 1	2/0	3/0
AAC Compressed or Compacted	 6	3, 4	1, 2	1/0	2/0	3/0
ACSR Compressed or Compacted	 6 6/1	4 6/1, 7/1	2 6/1, 7/1	1/0, 1 6/1	2/0 6/1	3/0 6/1
AWAC, ACAR	 -	4 6/1	4 5/2, 4/3, 3/4, 3 6/1, 5/2, 4/3, 2 6/1	4 2/5, 3 3/4, 2/5, 2 5/2, 4/3, 3/4, 1 6/1, 5/2, 4/3, 1/0 6/1	2 2/5, 1 3/4, 1/0 5/2, 4/3, 2/0 6/1	1 2/5, 1/0 3/4, 2/0 5/2, 4/3, 3/0 6/1
ALUMOWELD COPPERWELD	 8A, 8C, 3 No. 12	6A, 6C, 7A, 7D, 8D, 3 No. 9, 3 No. 10, 7 No. 12	2F, 4A, 5A, 5D, 6D, 3 No. 7, 3 No. 8, 7 No. 10, 7 No. 11	1/0F, 1F, 1G, 1J, 2A, 2G, 2J, 2K, 3A, 4D, 4N, 4P, 3 No. 5, 7 No. 8, 3 No. 6, 7 No. 9	2/0F, 1/0G, 1/0J, 1K, 2N, 7 No. 7	3/0F, 2/0G, 2/0J, 1/0F, 1N, 2P, 7 No. 6
Galvanized Steel	 3/16"	7/32", 1/4"	9/32", 5/16"	11/32", 3/8"	7/16"	1/2"
Solid: AL or CU	 4, 5, 6	2, 3	1/0, 1	2/0	3/0	4/0

Use TAP Number

600446*

600447*











600448*

600411*









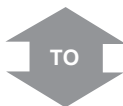
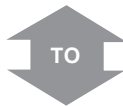

600458*

600459*

*UL Listed

S T R A N D E D	Large Wire Groove Code	G	F	T	K	H	L	
	ACSR Standard Round	 4/0 6/1	4/0 6/1	4/0 6/1	4/0 6/1	4/0 6/1	4/0 6/1	4/0 6/1
	AAAC 6201-5005	 4/0	4/0	4/0	4/0	4/0	4/0	4/0
	AAC Standard Round	 4/0	4/0	4/0	4/0	4/0	4/0	4/0
	COPPER Standard Round	 4/0	4/0	4/0	4/0	4/0	4/0	4/0
	AAC Compressed or Compacted	 4/0, 250.0, 266.8	4/0, 250.0, 266.8	4/0, 250.0, 266.8	4/0, 250.0, 266.8	4/0, 250.0, 266.8	4/0, 250.0, 266.8	4/0, 250.0, 266.8
	ACSR Compressed or Compacted	 4/0 6/1, 266.8 18/1	4/0 6/1, 266.8 18/1	4/0 6/1, 266.8 18/1	4/0 6/1, 266.8 18/1	4/0 6/1, 266.8 18/1	4/0 6/1, 266.8 18/1	4/0 6/1, 266.8 18/1
	AWAC, ACAR	 1/0 2/5, 2/0 3/4, 3/0 5/2, 4/3, 4/0 6/1	1/0 2/5, 2/0 3/4, 3/0 5/2, 4/3, 4/0 6/1	1/0 2/5, 2/0 3/4, 3/0 5/2, 4/3, 4/0 6/1	1/0 2/5, 2/0 3/4, 3/0 5/2, 4/3, 4/0 6/1	1/0 2/5, 2/0 3/4, 3/0 5/2, 4/3, 4/0 6/1	1/0 2/5, 2/0 3/4, 3/0 5/2, 4/3, 4/0 6/1	1/0 2/5, 2/0 3/4, 3/0 5/2, 4/3, 4/0 6/1
	ALUMOWELD COPPERWELD	 1/0K, 2/0K, 4/0F, 7 No. 5, 19 No. 10	1/0K, 2/0K, 4/0F, 7 No. 5, 19 No. 10	1/0K, 2/0K, 4/0F, 7 No. 5, 19 No. 10	1/0K, 2/0K, 4/0F, 7 No. 5, 19 No. 10	1/0K, 2/0K, 4/0F, 7 No. 5, 19 No. 10	1/0K, 2/0K, 4/0F, 7 No. 5, 19 No. 10	1/0K, 2/0K, 4/0F, 7 No. 5, 19 No. 10
	Galvanized Steel	 9/16"	9/16"	9/16"	9/16"	9/16"	9/16"	9/16"
Solid: AL or CU	 4/0, 250.0, 266.8, 300.0	4/0, 250.0, 266.8, 300.0	250.0, 266.8 300.0	250.0, 266.8, 300.0	250.0, 266.8, 300.0	250.0, 266.8, 300.0	250.0, 266.8, 300.0	



S T R A N D E D	ACSR Standard Round	 6 6/1	4 6/1, 7/1, 5 6/1	2 6/1, 7/1, 3 6/1	1/0, 1 6/1	2/0 6/1	3/0 6/1
	AAAC 6201-5005	 6	4, 5	2, 3	1/0, 1	2/0	3/0
	AAC Standard Round	 6	4, 5	2, 3	1/0, 1	2/0	3/0
	COPPER Standard Round	 6	4, 5	2, 3	1/0, 1	2/0	3/0
	AAC Compressed or Compacted	 6	3, 4	1, 2	1/0	2/0	3/0
	ACSR Compressed or Compacted	 6 6/1	4 6/1, 7/1	2 6/1, 7/1	1/0, 1 6/1	2/0 6/1	3/0 6/1
	AWAC, ACAR	 -	4 6/1	2 6/1, 3 6/1, 5/2, 4/3, 4 5/2, 4/3, 3/4	1/0 6/1, 1 6/1, 5/2, 4/3, 2 5/2, 4/3, 3/4, 3 3/4, 2/5, 4 2/5	2 2/5, 1 3/4, 1/0 5/2, 4/3, 2/0 6/1	1 2/5, 1/0 3/4, 2/0 5/2, 4/3, 3/0 6/1
	ALUMOWELD COPPERWELD	 8A, 8C, 3 No. 12	6A, 6C, 7A, 7D, 8D, 3 No. 9, 3 No. 10, 7 No. 12	2F, 4A, 5A, 5D, 6D, 3 No. 7, 3 No. 8, 7 No. 10, 7 No. 11	1/0F, 1F, 1G, 1J, 2A, 2G, 2J, 2K, 3A, 4D, 4N, 4P, 3 No. 5, 7 No. 8, 3 No. 6, 7 No. 9	2N, 1K, 1/0G, 1/0J, 2/0F, 7 No. 7	2P, 1N, 1/0F, 2/0J, 3/0F, 7 No. 6
	Galvanized Steel	 3/16"	7/32", 1/4"	9/32", 5/16"	11/32", 3/8"	7/16"	1/2"
	Solid: AL or CU	 4, 5, 6	2, 3, 4	1/0, 1	2/0	3/0	4/0

Use TAP Number

600455*

600456*











600411*

600458*









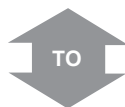
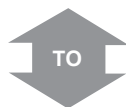
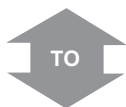
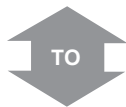

600459*

600465*

*UL Listed

S T R A N D E D	Large Wire Groove Code	M	1	2	3	4	5	
	ACSR Standard Round		4/0 6/1	266.8 6/7, 18/1, 24/7, 26/7	266.8 6/7, 18/1, 24/7, 26/7	266.8 6/7, 18/1, 24/7, 26/7	266.8 6/7, 18/1, 24/7, 26/7	266.8 6/7, 18/1, 24/7, 26/7
	AAAC 6201-5005		4/0	281.4, 307.1, 312.8	281.4, 307.1, 312.8	281.4, 307.1, 312.8	281.4, 307.1, 312.8	281.4, 307.1, 312.8
	AAC Standard Round		4/0	250.0, 266.8, 300.0	250.0, 266.8, 300.0	250.0, 266.8, 300.0	250.0, 266.8, 300.0	250.0, 266.8, 300.0
	COPPER Standard Round		4/0	250.0, 300.0	250.0, 300.0	250.0, 300.0	250.0, 300.0	250.0, 300.0
	AAC Compressed or Compacted		4/0, 250.0, 266.8	300.0, 336.4, 350.0	300.0, 336.4, 350.0	300.0, 336.4, 350.0	300.0, 336.4, 350.0	300.0, 336.4, 350.0
	ACSR Compressed or Compacted		4/0 6/1, 266.8 18/1	266.8, 336.4 18/1	266.8, 336.4 18/1	266.8, 336.4 18/1	266.8, 336.4 18/1	266.8, 336.4 18/1
	AWAC, ACAR		1/0 2/5, 2/0 3/4, 3/0 5/2, 4/3, 4/0 6/1	4/0 15/4	4/0 15/4	4/0 15/4	4/0 15/4	4/0 15/4
	ALUMOWELD COPPERWELD		1/0K, 2/0K, 4/0F, 7 No. 5, 19 No. 10	4/0E, 4/0G, 7 No. 4, 19 No. 8, 19 No. 9	4/0E, 4/0G, 7 No. 4, 19 No. 8, 19 No. 9	4/0E, 4/0G, 7 No. 4, 19 No. 8, 19 No. 9	4/0E, 4/0G, 7 No. 4, 19 No. 8, 19 No. 9	4/0E, 4/0G, 7 No. 4, 19 No. 8, 19 No. 9
	Galvanized Steel		9/16"	5/8"	5/8"	5/8"	5/8"	5/8"
Solid: AL or CU		250.0, 266.8, 300.0	336.4, 350.0, 397.5, 400.0	336.4, 350.0, 397.5, 400.0	336.4, 350.0, 397.5, 400.0	336.4, 350.0, 397.5, 400.0	336.4, 350.0, 397.5, 400.0	



ACSR Standard Round		4/0 6/1	6 6/1	4 6/1, 7/1, 5 6/1	2 6/1, 7/1, 3 6/1	1/0, 1 6/1	2/0 6/1
AAAC 6201-5005		4/0	6	4, 5	2, 3	1/0, 1	2/0
AAC Standard Round		4/0	6	4, 5	1, 2, 3	1/0	2/0
COPPER Standard Round		4/0	6	4, 5	1, 2, 3	1/0	2/0
AAC Compressed or Compacted		4/0, 250.0, 266.8	6	3, 4	1, 2	1/0, 2/0	3/0
ACSR Compressed or Compacted		4/0 6/1, 266.8 18/1	6 6/1	4 6/1, 7/1	1 6/1, 2 6/1, 7/1	1/0, 2/0 6/1	3/0 6/1
AWAC, ACAR		1/0 2/5, 2/0 3/4, 3/0 5/2, 4/3, 4/0 6/1	—	4 6/1	2 6/1, 5/2, 3 6/1, 5/2, 4/3, 4 4/3, 3/4, 5/2	4 2/5, 3 3/4, 2/5, 2 4/3, 3/4, 1 6/1, 5/2, 4/3, 1/0 6/1	2 2/5, 1 3/4, 1/0 5/2, 4/3, 2/0 6/1
ALUMOWELD COPPERWELD		1/0K, 2/0K, 4/0F, 7 No. 5, 19 No. 10	8A, 8C, 3 No. 12	5A, 6A, 6C, 7A, 7D, 8D, 3 No. 9, 3 No. 10, 7 No. 12	2F, 2G, 3A, 4A, 4N, 5D, 6D 3 No. 7, 3 No. 8, 7 No. 10, 7 No. 11	1/0F, 1F, 1G, 1J, 2A, 2J, 2K, 4D, 4P, 3 No. 5, 7 No. 8, 3 No. 6, 7 No. 9	1K, 1/0G, 1/0J, 2N, 2P, 2/0F, 7 No. 7
Galvanized Steel		9/16"	3/16"	7/32", 1/4"	9/32", 5/16"	11/32", 3/8"	7/16"
Solid: AL or CU		250.0, 266.8, 300.0	4, 5, 6	2, 3	1/0, 1	2/0, 3/0	4/0

Use TAP Number

600466*

602046-1*

602046-2*

602046-3*









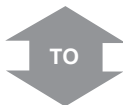
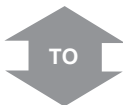
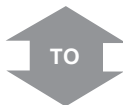
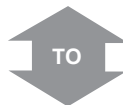
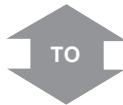

602046-4*

602046-5*

*UL Listed

S T R A N D E D	Large Wire Groove Code	6	7	9	19	18	17	
	ACSR Standard Round 	266.8 6/7, 18/1, 24/7, 26/7	266.8 6/7, 18/1, 24/7, 26/7	266.8 6/7, 18/1, 24/7, 26/7	266.8 6/7, 18/1, 24/7, 26/7	266.8 6/7, 18/1, 24/7, 26/7, 30/7, 300.0 18/1, 24/7, 26/7, 336.4 18/1	266.8 6/7, 18/1, 24/7, 26/7, 30/7, 300.0 18/1, 24/7, 26/7, 336.4 18/1	266.8 6/7, 18/1, 24/7, 26/7, 30/7, 300.0 18/1, 24/7, 26/7, 336.4 18/1
	AAAC 6201-5005 	281.4, 307.1, 312.8	281.4, 307.1, 312.8	281.4, 307.1, 312.8	281.4, 307.1, 312.8, 355.1	281.4, 307.1, 312.8, 355.1	281.4, 307.1, 312.8, 355.1	281.4, 307.1, 312.8, 355.1
	AAC Standard Round 	250.0, 266.8, 300.0	250.0, 266.8, 300.0	250.0, 266.8, 300.0	300.0, 336.4, 350.0	300.0, 336.4, 350.0	300.0, 336.4, 350.0	300.0, 336.4, 350.0
	COPPER Standard Round 	250.0, 300.0	250.0, 300.0	250.0, 300.0	250.0, 300.0, 350.0	250.0, 300.0, 350.0	250.0, 300.0, 350.0	250.0, 300.0, 350.0
	AAC Compressed or Compacted 	300.0, 336.4, 350.0	300.0, 336.4, 350.0	300.0, 336.4, 350.0	336.4, 350.0, 397.5	336.4, 350.0, 397.5	336.4, 350.0, 397.5	336.4, 350.0, 397.5
	ACSR Compressed or Compacted 	266.8, 336.4 18/1	266.8, 336.4 18/1	266.8, 336.4 18/1	336.4, 397.5 18/1	336.4, 397.5 18/1	336.4, 397.5 18/1	336.4, 397.5 18/1
	AWAC, ACAR 	4/0 15/4	4/0 15/4	4/0 15/4	336.4 18/1, 343.6 15/4, 355.0 15/4, 12/7	336.4 18/1, 343.6 15/4, 355.0 15/4, 12/7	336.4 18/1, 343.6 15/4, 355.0 15/4, 12/7	336.4 18/1, 343.6 15/4, 355.0 15/4, 12/7
	ALUMOWELD COPPERWELD 	4/OE, 4/OG, 7 No. 4, 19 No. 8, 19 No. 9	4/OE, 4/OG, 7 No. 4, 19 No. 8, 19 No. 9	4/OE, 4/OG, 7 No. 4, 19 No. 8, 19 No. 9	4/OE, 7 No. 4, 19 No. 8	4/OE, 7 No. 4, 19 No. 8	4/OE, 7 No. 4, 19 No. 8	4/OE, 7 No. 4, 19 No. 8
	Galvanized Steel 	5/8"	5/8"	5/8"	5/8"	5/8"	5/8"	5/8"
Solid: AL or CU 	336.4, 350.0, 397.5, 400.0	336.4, 350.0, 397.5, 400.0	336.4, 350.0, 397.5, 400.0	397.5, 400.0, 450.0	397.5, 400.0, 450.0	397.5, 400.0, 450.0	397.5, 400.0, 450.0	



ACSR Standard Round 	3/0 6/1	4/0 6/1	266.8 6/7, 18/1, 24/7, 26/7	6 6/1	4 6/1, 7/1, 5 6/1	2 6/1, 7/1, 3 6/1
AAAC 6201-5005 	3/0	4/0	281.4, 307.1, 312.8	6	4, 5	2, 3
AAC Standard Round 	3/0	4/0, 250.0	266.8, 300.0	6	4, 5	1, 2, 3
COPPER Standard Round 	3/0	4/0, 250.0	300.0	6	4, 5	1, 2, 3
AAC Compressed or Compacted 	4/0, 250.0	266.8, 300.0	336.4, 350.0	6	3, 4	1, 2
ACSR Compressed or Compacted 	4/0 6/1	266.8 18/1	336.4 18/1	6 6/1	4 6/1, 7/1	1 6/1, 2 6/1, 7/1
AWAC, ACAR 	1 2/5, 1/0 3/4, 2/0 5/2, 4/3, 3/0 6/1	1/0 2/5, 2/0 3/4, 3/0 5/2, 4/3, 4/0 6/1, 15/4	—	—	4 6/1	2 6/1, 5/2, 3 6/1, 5/2, 4/3, 4 4/3, 3/4, 5/2
ALUMOWELD COPPERWELD 	1N, 1/OK, 2/OG, 2/OJ, 3/OF, 7 No. 6, 19 No. 10	2/OK, 4/OF, 7 No. 5, 19 No. 10	4/OE, 4/OG, 7 No. 4, 19 No. 8	8A, 8C, 3 No. 12	5A, 6A, 6C, 7A, 7D, 8D, 3 No. 9, 3 No. 10, 7 No. 12	2F, 2G, 3A, 4A, 4N, 5D, 6D, 3 No. 7, 3 No. 8, 7 No. 10, 7 No. 11
Galvanized Steel 	1/2"	9/16"	5/8"	3/16"	7/32", 1/4"	9/32", 5/16"
Solid: AL or CU 	250.0, 266.8	300.0	336.4, 350.0, 397.5, 400.0	4, 5, 6	2, 3	1/0, 1

Use TAP Number

602046-6*

602046-7*











602046-9*

602380*











602380-1*

602380-2*

*UL Listed











Large Wire Groove Code		5	6	7	9	16
S T R A N D E D	ACSR Standard Round 	266.8 6/7, 18/1, 24/7, 26/7, 30/7, 300.0 18/1, 24/7, 26/7, 336.4 18/1	266.8 6/7, 18/1, 24/7, 26/7, 30/7, 300.0 18/1, 24/7, 26/7, 336.4 18/1	266.8 6/7, 18/1, 24/7, 26/7, 30/7, 300.0 18/1, 24/7, 26/7, 336.4 18/1	266.8 6/7, 18/1, 24/7, 26/7, 30/7, 300.0 18/1, 24/7, 26/7, 336.4 18/1	266.8 6/7, 18/1, 24/7, 26/7, 30/7, 300.0 18/1, 24/7, 26/7, 336.4 18/1
	AAAC 6201-5005 	281.4, 307.1, 312.8, 355.1	281.4, 307.1, 312.8, 355.1	281.4, 307.1, 312.8, 355.1	281.4, 307.1, 312.8, 355.1	281.4, 307.1, 312.8, 355.1
	AAC Standard Round 	300.0, 336.4, 350.0	300.0, 336.4, 350.0	300.0, 336.4, 350.0	300.0, 336.4, 350.0	300.0, 336.4, 350.0
	COPPER Standard Round 	250.0, 300.0, 350.0	250.0, 300.0, 350.0	250.0, 300.0, 350.0	250.0, 300.0, 350.0	250.0, 300.0, 350.0
	AAC Compressed or Compacted 	336.4, 350.0, 397.5	336.4, 350.0, 397.5	336.4, 350.0, 397.5	336.4, 350.0, 397.5	336.4, 350.0, 397.5
	ACSR Compressed or Compacted 	336.4, 397.5 18/1	336.4, 397.5 18/1	336.4, 397.5 18/1	336.4, 397.5 18/1	336.4, 397.5 18/1
	AWAC, ACAR 	336.4 18/1, 343.6 15/4, 355.0 15/4, 12/7	336.4 18/1, 343.6 15/4, 355.0 15/4, 12/7	336.4 18/1, 343.6 15/4, 355.0 15/4, 12/7	336.4 18/1, 343.6 15/4, 355.0 15/4, 12/7	336.4 18/1, 343.6 15/4, 355.0 15/4, 12/7
	ALUMOWELD COPPERWELD 	4/0 E, 7 No. 4, 19 No. 8	4/0 E, 7 No. 4, 19 No. 8	4/0 E, 7 No. 4, 19 No. 8	4/0 E, 7 No. 4, 19 No. 8	4/0 E, 7 No. 4, 19 No. 8
	Galvanized Steel 	5/8"	5/8"	5/8"	5/8"	5/8"
	Solid: AL or CU 	397.5, 400.0, 450.0	397.5, 400.0, 450.0	397.5, 400.0, 450.0	397.5, 400.0, 450.0	397.5, 400.0, 450.0













S T R A N D E D	ACSR Standard Round 	1/0, 1 6/1	2/0 6/1	3/0 6/1	4/0 6/1	266.8 6/7, 18/1, 24/7, 26/7, 30/7, 300.0 18/1, 24/7, 26/7, 336.4 18/1
	AAAC 6201-5005 	1/0, 1	2/0	3/0	4/0	281.4, 307.1, 312.8, 355.1
	AAC Standard Round 	1/0	2/0	3/0	4/0, 250.0, 266.8	300.0, 336.4, 350.0
	COPPER Standard Round 	1/0	2/0	3/0	4/0, 250.0	–
	AAC Compressed or Compacted 	1/0, 2/0	3/0	4/0, 250.0	266.8, 300.0	336.4, 350.0
	ACSR Compressed or Compacted 	1/0, 2/0 6/1	3/0 6/1	4/0 6/1	266.8 18/1	336.4 18/1
	AWAC, ACAR 	4 2/5, 3 3/4, 2/5, 2 4/3, 3/4, 1 6/1, 5/2, 4/3, 1/0 6/1	2 2/5, 1 3/4, 1/0 5/2, 4/3, 2/0 6/1	1 2/5, 1/0 3/4, 2/0 5/2, 4/3, 3/0 6/1	1/0 2/5, 2/0 3/4, 3/0 5/2, 4/3, 4/0 6/1, 15/4	336.4 18/1, 343.6 15/4, 350.0 15/4, 12/7
	ALUMOWELD COPPERWELD 	1/0F, 1F, 1G, 1J, 2A, 2J, 2K, 4D, 4P, 3 No. 5, 3 No. 6, 7 No. 8, 7 No. 9	1K, 1/0G, 1/0J, 2N, 2P, 2/0F, 7 No. 7	1N, 1/0K, 2/0G, 2/0J, 3/0F, 7 No. 6, 19 No. 10	2/0K, 4/0F, 4/0G, 7 No. 5, 19 No. 9	4/0E, 7 No. 4, 19 No. 8
	Galvanized Steel 	11/32", 3/8"	7/16"	1/2"	9/16"	5/8"
	Solid: AL or CU 	2/0, 3/0	4/0	250.0, 266.8	350.0, 336.4, 300.0	–

Use TAP Number 602380-3* 602380-4* 602380-5* 602380-6* 602380-7*

*UL Listed











Large Wire Groove Code							
S T R A N D E D	ACSR Standard Round 	336.4 18/1, 24/7, 26/7, 266.8 30/7, 300.0 18/1 24/7, 26/7, 30/7	336.4 18/1, 24/7, 26/7, 266.8 30/7, 300.0 18/1 24/7, 26/7, 30/7	336.4 18/1, 24/7, 26/7, 266.8 30/7, 300.0 18/1 24/7, 26/7, 30/7	336.4 18/1, 24/7, 26/7, 266.8 30/7, 300.0 18/1 24/7, 26/7, 30/7	336.4 18/1, 24/7, 26/7, 266.8 30/7, 300.0 18/1 24/7, 26/7, 30/7	336.4 18/1, 24/7, 26/7, 266.8 30/7, 300.0 18/1 24/7, 26/7, 30/7
	AAAC 6201-5005 	355.1	355.1	355.1	355.1	355.1	355.1
	AAC Standard Round 	336.4, 350.0 397.5, 400.0	336.4, 350.0 397.5, 400.0	336.4, 350.0 397.5, 400.0	336.4, 350.0 397.5, 400.0	336.4, 350.0 397.5, 400.0	336.4, 350.0 397.5, 400.0
	COPPER Standard Round 	350.0, 400.0	350.0, 400.0	350.0, 400.0	350.0, 400.0	350.0, 400.0	350.0, 400.0
	AAC Compressed or Compacted 	336.4, 350.0, 397.5	336.4, 350.0, 397.5	336.4, 350.0, 397.5	336.4, 350.0, 397.5	336.4, 350.0, 397.5	336.4, 350.0, 397.5
	ACSR Compressed or Compacted 	336.4, 397.5 18/1	336.4, 397.5 18/1	336.4, 397.5 18/1	336.4, 397.5 18/1	336.4, 397.5 18/1	336.4, 397.5 18/1
	AWAC, ACAR 	336.4 18/1, 16/3, 15/4, 343.6 15/4, 355.0 15/4, 12/7	336.4 18/1, 16/3, 15/4, 343.6 15/4, 355.0 15/4, 12/7	336.4 18/1, 16/3, 15/4, 343.6 15/4, 355.0 15/4, 12/7	336.4 18/1, 16/3, 15/4, 343.6 15/4, 355.0 15/4, 12/7	336.4 18/1, 16/3, 15/4, 343.6 15/4, 355.0 15/4, 12/7	336.4 18/1, 16/3, 15/4, 343.6 15/4, 355.0 15/4, 12/7
	ALUMOWELD COPPERWELD 	4/0 E, 19 No. 7, 19 No. 8, 7 No. 4, 37 No. 10	4/0 E, 19 No. 7, 19 No. 8, 7 No. 4, 37 No. 10	4/0 E, 19 No. 7, 19 No. 8, 7 No. 4, 37 No. 10	4/0 E, 19 No. 7, 19 No. 8, 7 No. 4, 37 No. 10	4/0 E, 19 No. 7, 19 No. 8, 7 No. 4, 37 No. 10	4/0 E, 19 No. 7, 19 No. 8, 7 No. 4, 37 No. 10
	Galvanized Steel 	5/8"	5/8"	5/8"	5/8"	5/8"	5/8"
	Solid: AL or CU 	450.0, 477.0, 500.0	450.0, 477.0, 500.0	450.0, 477.0, 500.0	450.0, 477.0, 500.0	450.0, 477.0, 500.0	450.0, 477.0, 500.0













S T R A N D E D	ACSR Standard Round 	6 6/1	4 6/1, 7/1, 5 6/1	2 6/1, 7/1, 3 6/1	1/0, 1 6/1	2/0 6/1	3/0 6/1
	AAAC 6201-5005 	6	4, 5	2, 3	1/0, 1	2/0	3/0
	AAC Standard Round 	6	4, 5	2, 3	1/0, 1	2/0	3/0
	COPPER Standard Round 	6	4, 5	2, 3	1/0, 1	2/0	3/0
	AAC Compressed or Compacted 	6	3, 4	1, 2	1/0	2/0	3/0, 4/0
	ACSR Compressed or Compacted 	6 6/1	4 6/1, 7/1	2 6/1, 7/1	1/0, 1 6/1	2/0 6/1	3/0 6/1
	AWAC, ACAR 	-	4 6/1	2 6/1, 3 6/1, 5/2, 4/3, 4 5/2, 4/3, 3/4	1/0 1/6, 1 6/1, 5/2, 4/3, 2 5/2, 4/3, 3/4, 3 3/4, 2/5, 4 2/5	2 2/5, 1 3/4, 1/0 5/2, 4/3, 2/0 6/1, 4/3,	1 2/5, 1/0 3/4, 2/0 5/2, 3/0 6/1
	ALUMOWELD COPPERWELD 	8A, 8C, 3 No. 12	6A, 6C, 7A, 7D, 8D, 3 No. 9, 3 No. 10, 7 No. 10	2F, 4A, 5A, 5D, 6D, 3 No. 7, 3 No. 8, 7 No. 10, 7 No. 11	1/0F, 1F, 1G, 1J, 2A, 2G, 2J, 2K, 3A, 4D, 4N, 4P, 3 No. 5, 3 No. 6, 7 No. 8, 7 No. 9	2N, 1K, 1/0G, 1/0J, 2/0F, 7 No. 7	2P, 1N, 2/0G, 2/0J, 3/0F, 7 No. 6
	Galvanized Steel 	3/16"	7/32", 1/4"	9/32", 5/16"	11/32", 3/8"	7/16"	1/2"
	Solid: AL or CU 	4, 5, 6	2, 3, 4	1/0, 1, 2	1/0, 2/0	2/0, 3/0	4/0

Use TAP Number 602014* 602013* 602000* 602001* 602002* 602003*

*UL Listed











Large Wire Groove Code							
S T R A N D E D	ACSR Standard Round 	336.4 18/1, 24/7, 26/7, 266.8 30/7, 300.0 18/1 24/7, 26/7, 30/7	336.4 18/1, 24/7, 26/7, 266.8 30/7, 300.0 18/1 24/7, 26/7, 30/7	336.4 18/1, 24/7, 26/7, 266.8 30/7, 300.0 18/1 24/7, 26/7, 30/7	477.0, 397.5 18/1, 24/7, 26/7, 397.5, 336.4 30/7	477.0, 397.5 18/1, 24/7, 26/7, 397.5, 336.4 30/7	477.0, 397.5 18/1, 24/7, 26/7, 397.5, 336.4 30/7
	AAAC 6201-5005 	355.1	355.1	355.1	419.6, 465.4, 466.3, 503.6, 559.5	419.6, 465.4, 466.3, 503.6, 559.5	419.6, 465.4, 466.3, 503.6, 559.5
	AAC Standard Round 	336.4, 350.0 397.5, 400.0	336.4, 350.0 397.5, 400.0	336.4, 350.0 397.5, 400.0	450.0, 477.0, 500.0, 550.0, 556.5	450.0, 477.0, 500.0, 550.0, 556.5	450.0, 477.0, 500.0, 550.0, 556.5
	COPPER Standard Round 	350.0, 400.0	350.0, 400.0	350.0, 400.0	450.0, 500.0, 550.0	450.0, 500.0, 550.0	450.0, 500.0, 550.0
	AAC Compressed or Compacted 	336.4, 350.0, 397.5	336.4, 350.0, 397.5	336.4, 350.0, 397.5	-	-	-
	ACSR Compressed or Compacted 	336.4, 397.5 18/1	336.4, 397.5 18/1	336.4, 397.5 18/1	477.0, 556.5	477.0, 556.5	477.0, 556.5
	AWAC, ACAR 	336.4 18/1, 16/3, 15/4, 343.6 15/4, 355.0 15/4, 12/7	336.4 18/1, 16/3, 15/4, 343.6 15/4, 355.0 15/4, 12/7	336.4 18/1, 16/3, 15/4, 343.6 15/4, 355.0 15/4, 12/7	503.6 15/4, 12/7	503.6 15/4, 12/7	503.6 15/4, 12/7
	ALUMOWELD COPPERWELD 	4/0 E, 19 No. 7, 19 No. 8, 7 No. 4, 37 No. 10	4/0 E, 19 No. 7, 19 No. 8, 7 No. 4, 37 No. 10	4/0 E, 19 No. 7, 19 No. 8, 7 No. 4, 37 No. 10	19 No. 6, 37 No. 9	19 No. 6, 37 No. 9	19 No. 6, 37 No. 9
	Galvanized Steel 	5/8"	5/8"	5/8"	3/4"	3/4"	3/4"
	Solid: AL or CU 	450.0, 477.0, 500.0	450.0, 477.0, 500.0	450.0, 477.0, 500.0	-	-	-











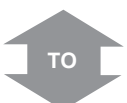
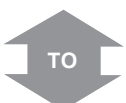
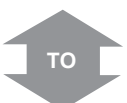
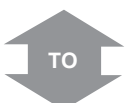
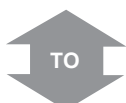
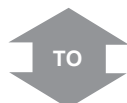

S T R A N D E D	ACSR Standard Round 	4/0 1/6	266.8 6/7, 18/1, 24/7, 26/7, 4/0 6/1	300.0, 336.4 18/1, 24/7, 26/7, 266.8, 300.0 30/7, 266.8 6/7	6 6/1	4 6/1, 7/1, 5 6/1	2 6/1, 7/1, 3 6/1
	AAAC 6201-5005 	4/0	4/0, 281.4, 307.1, 312.8	355.1, 394.5	6	4, 5	2, 3
	AAC Standard Round 	4/0	250.0, 266.8, 300.0	336.4, 350.0, 397.5, 400.0	6	4, 5	2, 3
	COPPER Standard Round 	4/0	250.0, 300.0	350.0, 400.0	6	4, 5	2, 3
	AAC Compressed or Compacted 	250.0, 266.8	300.0, 336.4, 350.0	397.5	6	3, 4	1, 2
	ACSR Compressed or Compacted 	4/0 6/1, 266.8 18/1	266.8 18/1	397.5 18/1	6 6/1	4 6/1, 7/1	2 6/1, 7/1
	AWAC, ACAR 	1/0 2/5, 2/0 3/4, 3/0 5/2, 4/3, 4 6/1	4/0 15/4	336.4 18/1, 16/3, 15/4, 355.0 15/4, 12/7, 343.6 15/4	-	4 6/1	2 6/1, 3 6/1, 5/2, 4/3, 4 5/2, 4/3, 3/4
	ALUMOWELD COPPERWELD 	2/0K, 4/0F 7 No. 5, 19 No. 10	4/0G, 7 No. 4, 19 No. 8, 19 No. 9	19 No. 7, 37 No.10	8A, 8C, 3 No. 12	6A, 6C, 7A, 7D, 8D, 3 No. 9, 3 No. 10, 7 No. 12	2F, 4A, 5A, 5D, 6D, 3 No. 7, 3 No. 8, 7 No. 10, 7 No. 11
	Galvanized Steel 	9/16"	9/16", 5/8"	-	3/16"	7/32", 1/4"	9/32", 5/16"
	Solid: AL or CU 	250.0, 266.8, 300.0	336.4, 350.0, 397.5, 400.0	450.0, 477.0, 500.0	4, 5, 6	2, 3, 4	1/0, 1, 2

Use TAP Number **602004*** **602006*** **602007*** **I-602031-0*** **602031-9*** **602031-8***

*UL Listed











Large Wire Groove Code								
S T R A N S M I T T E R	ACSR Standard Round 	477.0 26/7, 24/7, 18/1, 336.4 30/7, 397.5 30/7 26/7, 24/7, 18/1	477.0 26/7, 24/7, 18/1, 336.4 30/7, 397.5 30/7 26/7, 24/7, 18/1	477.0 26/7, 24/7, 18/1, 336.4 30/7, 397.5 30/7 26/7, 24/7, 18/1	477.0 26/7, 24/7, 18/1, 336.4 30/7, 397.5 30/7 26/7, 24/7, 18/1	477.0 26/7, 24/7, 18/1, 336.4 30/7, 397.5 30/7 26/7, 24/7, 18/1	477.0 26/7, 24/7, 18/1, 336.4 30/7, 397.5 30/7 26/7, 24/7, 18/1	
	AAAC 6201-5003 	419.5, 466.3, 465.4, 503.6	419.5, 466.3, 465.4, 503.6	419.5, 466.3, 465.4, 503.6	419.5, 466.3, 465.4, 503.6	419.5, 466.3, 465.4, 503.6	419.5, 466.3, 465.4, 503.6	419.5, 466.3, 465.4, 503.6
	AAC Standard Round 	450.0, 477.0, 500.0, 550.0, 556.5	450.0, 477.0, 500.0, 550.0, 556.5	450.0, 477.0, 500.0, 550.0, 556.5	450.0, 477.0, 500.0, 550.0, 556.5	450.0, 477.0, 500.0, 550.0, 556.5	450.0, 477.0, 500.0, 550.0, 556.5	450.0, 477.0, 500.0, 550.0, 556.5
	COPPER Standard Round 	450.0, 500.0, 550.0	450.0, 500.0, 550.0	450.0, 500.0, 550.0	450.0, 500.0, 550.0	450.0, 500.0, 550.0	450.0, 500.0, 550.0	450.0, 500.0, 550.0
	AAC Compressed or Compacted 	–	–	–	–	–	–	–
	ACSR Compressed or Compacted 	477.0, 556.5	477.0, 556.5	477.0, 556.5	477.0, 556.5	477.0, 556.5	477.0, 556.5	477.0, 556.5
	AWAC, ACAR 	503.6 15/4, 12/7	503.6 15/4, 12/7	503.6 15/4, 12/7	503.6 15/4, 12/7	503.6 15/4, 12/7	503.6 15/4, 12/7	503.6 15/4, 12/7
	ALUMOWELD COPPERWELD 	19 No. 6, 37 No. 9	19 No. 6, 37 No. 9	19 No. 6, 37 No. 9	19 No. 6, 37 No. 9	19 No. 6, 37 No. 9	19 No. 6, 37 No. 9	19 No. 6, 37 No. 9
	Galvanized Steel 	3/4"	3/4"	3/4"	3/4"	3/4"	3/4"	3/4"
	Solid: AL or CU 	–	–	–	–	–	–	–













S T R A N S M I T T E R	ACSR Standard Round 	1/0 6/1	2/0 6/1	3/0 6/1	4/0 6/1	266.8 30/7, 24/7, 6/7, 18/1	266.8 30/7, 24/7, 6/7, 18/1
	AAAC 6201-5003 	1/0	2/0	3/0	4/0	281.4, 307.1, 312.8	355.1, 394.5
	AAC Standard Round 	1/0	2/0	3/0	4/0	250.0, 266.8, 300.0	336.4, 350.0, 397.5, 400.0
	COPPER Standard Round 	1/0	2/0	3/0	4/0	250.0, 300.0	350.0, 400.0
	AAC Compressed or Compacted 	1/0	2/0	3/0	250.0, 266.8	300.0, 336.4	397.5
	ACSR Compressed or Compacted 	1/0 6/1	2/0 6/1	3/0 6/1	266.8 18/1, 4/0 6/1	336.4 18/1	397.5
	AWAC, ACAR 	3 3/4, 2 4/3, 1 5/2, 6/1	2/0 6/1, 1/0 5/2, 6/1, 1 3/4, 4/3, 2 2/5, 3/4, 3 2/5	3/0 6/1, 2/0 4/3, 5/2, 1/0 3/4, 4/3, 1 2/5	4/0 6/1, 3/0 5/2, 2/0 3/4, 1/0 2/5	3/0 4/3, 4/0 15/4	355.0 15/4, 12/7, 343.6 15/4, 336.4 15/4, 16/3, 18/1
	ALUMOWELD COPPERWELD 	4P, 2K, 2J, 1G, 1F, 7 No. 9, 3 No. 6	2/OF, 1/OJ, 1/OG, 1/OF, 1K, 1J, 2N, 7 No. 7, 7 No. 8, 3 No. 5	3/OF, 2/OJ, 2/OG, 1/OK, 1N, 2P, 7 No.6	19 No. 10, 7 No. 5, 4/O F, 2/O K	19 No. 8, 19 No. 9, 7 No. 4, 4/O E, 4/O G	19 No. 7, 37 No. 10
	Galvanized Steel 	3/8"	7/16"	1/2"	–	9/16", 5/8"	–
	Solid: AL or CU 	2/0	3/0	4/0	300.0, 250.0	400.0, 350.0	450.0, 500.0

Use TAP Number I-602031-9* I-602031-8* I-602031-7* 1-602031-6* I-602031-5* I-602031-4*

*UL Listed

Large Wire Groove Code								
S T R A N D E D	ACSR Standard Round 	477.0 26/7, 24/7, 18/1, 336.4 30/7, 397.5 30/7 26/7, 24/7, 18/1	556.5 26/7, 24/7, 18/1, 477.0 30/7, 26/7	556.5 26/7, 24/7, 18/1, 477.0 30/7, 26/7	556.5 26/7, 24/7, 18/1, 477.0 30/7, 26/7	556.5 26/7, 24/7, 18/1, 477.0 30/7, 26/7	556.5 26/7, 24/7, 18/1, 477.0 30/7, 26/7	
	AAAC 6201-5003 	419.5, 466.3, 465.4, 503.6	559.5, 587.2, 599.6, 652.4, 652.8	559.5, 587.2, 599.6, 652.4, 652.8	559.5, 587.2, 599.6, 652.4, 652.8	559.5, 587.2, 599.6, 652.4, 652.8	559.5, 587.2, 599.6, 652.4, 652.8	559.5, 587.2, 599.6, 652.4, 652.8
	AAC Standard Round 	450.0, 477.0, 500.0, 550.0, 556.5	556.5, 600.0, 636.0	556.5, 600.0, 636.0	556.5, 600.0, 636.0	556.5, 600.0, 636.0	556.5, 600.0, 636.0	556.5, 600.0, 636.0
	COPPER Standard Round 	450.0, 500.0, 550.0	550.0, 600.0	550.0, 600.0	550.0, 600.0	550.0, 600.0	550.0, 600.0	550.0, 600.0
	AAC Compressed or Compacted 	—	—	—	—	—	—	—
	ACSR Compressed or Compacted 	477.0, 556.5	636.0 18/1	636.0 18/1	636.0 18/1	636.0 18/1	636.0 18/1	636.0 18/1
	AWAC, ACAR 	503.6 15/4, 12/7	653.1 15/4, 12/7, 568.3 15/4	653.1 15/4, 12/7, 568.3 15/4	653.1 15/4, 12/7, 568.3 15/4	653.1 15/4, 12/7, 568.3 15/4	653.1 15/4, 12/7, 568.3 15/4	653.1 15/4, 12/7, 568.3 15/4
	ALUMOWELD COPPERWELD 	19 No. 6, 37 No. 9	19 No. 5, 37 No. 8	19 No. 5, 37 No. 8	19 No. 5, 37 No. 8	19 No. 5, 37 No. 8	19 No. 5, 37 No. 8	19 No. 5, 37 No. 8
	Galvanized Steel 	3/4"	7/8"	7/8"	7/8"	7/8"	7/8"	7/8"
	Solid: AL or CU 	—	—	—	—	—	—	—



S T R A N D E D	ACSR Standard Round 	477.0 26/7, 24/7, 18/1, 397.5 30/7, 26/7	6 6/1	4 7/1, 6/1, 5 6/1	2 6/1, 3 6/1	2 6/1, 7/1	80.0 8/1, 1 6/1
	AAAC 6201-5003 	465.4, 466.3, 503.6, 559.5, 599.6	6	4, 5	3	2	1
	AAC Standard Round 	477.0, 500.0, 550.0, 556.5	6	3, 4	2	1	1/0
	COPPER Standard Round 	500.0, 550.0	5,6	4	2	1	1/0
	AAC Compressed or Compacted 	—	6	3, 4	2	1	1/0
	ACSR Compressed or Compacted 	556.5, 636.0 18/1	6 6/1	4 7/1, 6/1	2 6/1, 7/1	1 6/1	1/0 6/1
	AWAC, ACAR 	503.6 15/4, 12/7	—	4 6/1	4 4/3, 5/2, 3 5/2, 6/1	4 2/5, 3/4, 3 4/3, 2 5/2, 6/1	3 3/4, 2 4/3, 1 5/2, 6/1
	ALUMOWELD COPPERWELD 	19 No. 6, 37 No. 9	8A, 8C, 3 No. 12	8D, 7D, 7A, 6A, 6C, 3 No. 9, 3 No. 10, 7 No. 12	6D, 5D, 5A, 4A, 3 No. 8, 7 No. 11	4N, 3A, 2G, 2F, 3 No. 7, 7 No. 10	4D, 4P, 2K, 2A, 2J, 1G, 1F, 3 No. 6, 7 No. 9
	Galvanized Steel 	—	3/16"	1/4", 7/32"	9/32"	11/32"	3/8"
	Solid: AL or CU 	—	5, 6	4, 3	2, 1	1/0	2/0

Use TAP Number **I-602031-3*** **2-602031-2*** **2-602031-1*** **2-602031-0*** **1-602031-9*** **I-602031-8***

*UL Listed

Large Wire Groove Code							
S T R A N S M I T T E R	ACSR Standard Round	556.5 26/7, 24/7, 18/1, 477.0 30/7, 26/7	556.5 26/7, 24/7, 18/1, 477.0 30/7, 26/7	556.5 26/7, 24/7, 18/1, 477.0 30/7, 26/7	556.5 26/7, 24/7, 18/1, 477.0 30/7, 26/7	556.5 26/7, 24/7, 18/1, 477.0 30/7, 26/7	556.5 26/7, 24/7, 18/1, 477.0 30/7, 26/7
	AAAC 6201-5003	559.5, 587.2, 599.6, 652.4, 652.8	559.5, 587.2, 599.6, 652.4, 652.8	559.5, 587.2, 599.6, 652.4, 652.8	559.5, 587.2, 599.6, 652.4, 652.8	559.5, 587.2, 599.6, 652.4, 652.8	559.5, 587.2, 599.6, 652.4, 652.8
	AAC Standard Round	556.5, 600.0, 636.0	556.5, 600.0, 636.0	556.5, 600.0, 636.0	556.5, 600.0, 636.0	556.5, 600.0, 636.0	556.5, 600.0, 636.0
	COPPER Standard Round	550.0, 600.0	550.0, 600.0	550.0, 600.0	550.0, 600.0	550.0, 600.0	550.0, 600.0
	AAC Compressed or Compacted	–	–	–	–	–	–
	ACSR Compressed or Compacted	636.0 18/1	636.0 18/1	636.0 18/1	636.0 18/1	636.0 18/1	636.0 18/1
	AWAC, ACAR	653.1 15/4, 12/7, 568.3 15/4	653.1 15/4, 12/7, 568.3 15/4	653.1 15/4, 12/7, 568.3 15/4	653.1 15/4, 12/7, 568.3 15/4	653.1 15/4, 12/7, 568.3 15/4	653.1 15/4, 12/7, 568.3 15/4
	ALUMOWELD COPPERWELD	19 No. 5, 37 No. 8	19 No. 5, 37 No. 8	19 No. 5, 37 No. 8	19 No. 5, 37 No. 8	19 No. 5, 37 No. 8	19 No. 5, 37 No. 8
	Galvanized Steel	7/8"	7/8"	7/8"	7/8"	7/8"	7/8"
	Solid: AL or CU	–	–	–	–	–	–



S T R A N S M I T T E R	ACSR Standard Round	1/0 6/1	110.8, 101.8 12/7, 2/0 6/1	4/0 6/1, 3/0 6/1	266.8 30/7, 26/7, 24/7, 6/7, 18/1	336.4, 397.5 30/7, 26/7, 24/7, 18/1	477.0, 556.5 26/7, 24/7, 18/1, 477.0 30/7
	AAAC 6201-5003	1/0	2/0	4/0, 3/0	281.4, 307.1, 312.8	355.1, 394.5, 419.6, 465.4, 466.3	652.8, 652.4, 599.6, 503.6, 587.2, 559.2
	AAC Standard Round	2/0	3/0	4/0	250.0, 266.8, 300.0	336.4, 350.0, 397.5, 400.0, 450.0, 477.0	636.0, 600.0, 500.0, 550.0, 556.5
	COPPER Standard Round	2/0	3/0	4/0	250.0, 300.0	350.0, 400.0, 450.0	500.0, 600.0, 550.0
	AAC Compressed or Compacted	–	3/0	4/0, 250.0	266.8, 300.0, 336.4, 350.0	397.5, 477.0, 500.0	–
	ACSR Compressed or Compacted	2/0 6/1	3/0 6/1	266.8 18/1, 4/0 6/1	366.4 18/1	556.5, 397.5, 477.0 18/1	636.0 18/1
	AWAC, ACAR	1/0 5/2, 6/1, 1 3/4, 4/3, 2 2/5, 3/4, 3 2/5	3/0 6/1, 2/0 5/2, 6/1, 1/0 3/4, 4/3, 1 2/5	4/0 6/1, 3/0 5/2, 4/3, 2/0 3/4, 4/3, 1/0 2/5	4/0 15/4	336.4 15/4, 16/3, 18/1, 343.6 15/4, 355.0 15/4, 12/7	503.6, 653.1 15/4, 12/7, 568.3 15/4
	ALUMOWELD COPPERWELD	1/OG, 1/OF, 1K, 1J, 2N, 7 No.7, 7 No.8, 3 No. 5	3/OF, 2/OJ, 2/OG, 1/OK, 1/OJ, 1N, 2P, 2/OF, 7 No. 6	19 No. 9, 19 No. 10, 7 No. 5, 4/OF, 2/OK	19 No. 8, 7 No. 4, 4/OE, 4/OG	19 No. 7, 37 No. 9, 37 No. 10	19 No. 6, 19 No. 5, 37 No. 8
	Galvanized Steel	–	7/16"	9/16", 1/2"	5/8"	3/4"	7/8"
	Solid: AL or CU	3/0	4/0	300.0, 250.0	400.0, 350.0	450.0, 500.0	–

Use TAP Number I-602031-7* I-602031-6* I-602031-5* I-602031-4* I-602031-3* I-602031-2*

*UL Listed



















Large Wire Groove Code							
S T R A N D E D	ACSR Standard Round	605.0 54/7, 24/7, 653.9 18/3, 556.5 30/7	605.0 54/7, 24/7, 653.9 18/3, 556.5 30/7	605.0 54/7, 24/7, 653.9 18/3, 556.5 30/7	605.0 54/7, 24/7, 653.9 18/3, 556.5 30/7	605.0 54/7, 24/7, 653.9 18/3, 556.5 30/7	605.0 54/7, 24/7, 653.9 18/3, 556.5 30/7
	AAAC 6201-5003	—	—	—	—	—	—
	AAC Standard Round	—	—	—	—	—	—
	COPPER Standard Round	—	—	—	—	—	—
	AAC Compressed or Compacted	—	—	—	—	—	—
	ACSR Compressed or Compacted	—	—	—	—	—	—
	AWAC, ACAR	—	—	—	—	—	—
	ALUMOWELD COPPERWELD	—	—	—	—	—	—
	Galvanized Steel	—	—	—	—	—	—
	Solid: AL or CU	—	—	—	—	—	—











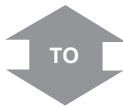
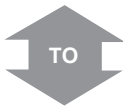
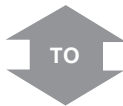
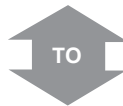
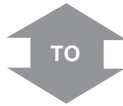

S T R A N D E D	ACSR Standard Round	4 7/1, 6/1, 5 6/1	2 7/1, 6/1, 3 6/1	1/0 6/1, 1 6/1, 80.0 8/1	2/0 6/1	3/0 6/1, 101.8, 110.8, 134.6 12/7	4/0 6/1, 159.0 12/7
	AAAC 6201-5003	4, 5	2, 3	1/0, 1	2/0	3/0	4/0
	AAC Standard Round	3, 4, 5	2	1/0	2/0	3/0	250.0, 4/0
	COPPER Standard Round	4, 5	2, 3	1/0	2/0	3/0	250.0, 4/0
	AAC Compressed or Compacted	3, 4	1, 2	2/0, 1/0	3/0	250.0, 4/0	266.8, 300.0
	ACSR Compressed or Compacted	4 7/1, 6/1	2 7/1, 6/1, 1 6/1	1/0 6/1	2/0 6/1	4/0 6/1, 3/0 6/1	266.8 18/1
	AWAC, ACAR	4 6/1	2 6/1, 3 5/2, 4/3, 6/1, 4 4/3, 3/4	1/0 6/1, 1 5/2, 4/3, 6/1, 2 4/3, 3/4, 3 3/4, 2/5, 4 2/5	2/0 6/1, 1/0 5/2, 4/3, 1 3/4, 2 2/5	2/0 5/2, 4/3, 3/0 5/2, 6/1, 1/0 3/4, 1 2/5	4/0 15/4, 6/1, 3/0 4/3, 2/0 3/4, 1/0 2/5
	ALUMOWELD COPPERWELD	5A, 6A, 6C, 7A, 7D, 8D, 7 No. 12, 3 No. 10, 3 No. 9	2F, 3A, 4A, 5D, 6D, 3 No. 8, 3 No. 7, 7 No. 10, 7 No. 11	1J, 1G, 1F, 2K, 2J, 2A, 4D, 4P, 1/0F, 3 No. 6, 3 No. 5, 7 No. 8, 7 No. 9	2/0F, 1/0G, 1/0J, 1K, 2N, 7 No. 7	3/0F, 2/0J, 2/0G, 1/0K, 1N, 2P, 7 No. 6, 19 No.10	4/0G, 4/0F, 2/0K, 19 No. 9, 7 No. 5
	Galvanized Steel	1/4", 7/32"	5/16", 9/32"	3/8", 11/32"	7/16"	1/2"	9/16"
	Solid: AL or CU	2, 3, 4	1/0, 1	2/0	3/0	250.0, 266.8, 4/0	300.0, 336.4

Use TAP Number **I-60121-4*** **I-602121-3*** **I-602121-2*** **1-602121-1*** **1-602121-0*** **602121-9***

*UL Listed

Large Wire Groove Code							
S T R A N S M I T T E R	ACSR Standard Round 	605.0 54/7, 24/7, 653.9 18/3, 556.5 30/7	605.0 54/7, 24/7, 653.9 18/3, 556.5 30/7	605.0 54/7, 24/7, 653.9 18/3, 556.5 30/7	605.0 54/7, 24/7, 653.9 18/3, 556.5 30/7	605.0 54/7, 24/7, 653.9 18/3, 556.5 30/7	605.0 54/7, 24/7, 653.9 18/3, 556.5 30/7
	AAAC 6201-5003 	–	–	–	–	–	–
	AAC Standard Round 	–	–	–	–	–	–
	COPPER Standard Round 	–	–	–	–	–	–
	AAC Compressed or Compacted 	–	–	–	–	–	–
	ACSR Compressed or Compacted 	–	–	–	–	–	–
	AWAC, ACAR 	–	–	–	–	–	–
	ALUMOWELD COPPERWELD 	–	–	–	–	–	–
	Galvanized Steel 	–	–	–	–	–	–
	Solid: AL or CU 	–	–	–	–	–	–



S T R A N S M I T T E R	ACSR Standard Round 	266.8 30/7, 26/7, 24/7, 18/1, 6/7, 300.0 30/7, 26/7, 24/7, 18/1, 176.9, 190.8 12/7	336.4 26/7, 24/7, 18/1, 211.3 12/7, 203.2 16/19	397.5 18/1, 336.4 30/7	477.0 30/7, 26/7, 24/7, 18/1, 397.5 30/7	556.5 18/1, 500.0 30/7	636.0 54/7, 30/19, 30/7, 26/7, 24/7, 18/1, 605.0, 653.9 18/3, 556.5 30/7
	AAAC 6201-5003 	281.4, 307.1, 312.8	355.1, 394.5	419.6	503.6, 559.5, 587.2, 599.6	–	704.6, 740.8, 746.1
	AAC Standard Round 	266.8, 300.0	336.4, 350.0	–	500.0, 550.0, 556.5	600.0	700.0, 715.5, 750.0
	COPPER Standard Round 	300.0	350.0, 400.0	–	500.0, 550.0	600.0	700.0, 750.0
	AAC Compressed or Compacted 	336.4, 350.0	397.5, 477.0	500.0	636.0	–	874.5
	ACSR Compressed or Compacted 	336.4, 18/1	397.5 18/1	477.0 18/1	556.5, 636.0 18/1	–	874.5 36/1
	AWAC, ACAR 	–	355.0 15/4, 12/7, 343.6 15/4, 336.4 15/4, 16/3, 18/1	–	568.3 15/4, 503.6 15/4, 12/7	–	739.8 30/7, 33/4, 24/13, 18/19
	ALUMOWELD COPPERWELD 	4/OE, 19 No. 8, 7 No. 4	19 No. 7, 37 No. 10	–	19 No. 6, 37 No. 9	37 No. 8	–
	Galvanized Steel 	5/8"	–	3/4"	7/8"	–	1"
	Solid: AL or CU 	350.0, 397.5, 400.0	450.0, 477.0, 500.0	–	–	–	–

Use TAP Number

602121-8*

602121-7*











602121-6*

602121-5*











602121-4*

602121-3*

*UL Listed











Large Wire Groove Code								
S T R A N S M I T T E R	ACSR Standard Round		605.0 54/7, 24/7, 653.9 18/3, 556.5 30/7	605.0 54/7, 24/7, 653.9 18/3, 556.5 30/7	605.0 54/7, 24/7, 653.9 18/3, 556.5 30/7	636.0 30/19, 30/7, 26/7, 24/7, 666.6 54/7, 26/7, 24/7, 715.5 45/7, 605.0 30/19, 30/7	636.0 30/19, 30/7, 26/7, 24/7, 666.6 54/7, 26/7, 24/7, 715.5 45/7, 605.0 30/19, 30/7	636.0 30/19, 30/7, 26/7, 24/7, 666.6 54/7, 26/7, 24/7, 715.5 45/7, 605.0 30/19, 30/7
	AAAC 6201-5003		–	–	–	740.8, 746.1	740.8, 746.1	740.8, 746.1
	AAC Standard Round		–	–	–	715.5, 750.0	715.5, 750.0	715.5, 750.0
	COPPER Standard Round		–	–	–	750.0	750.0	750.0
	AAC Compressed or Compacted		–	–	–	874.5	874.5	874.5
	ACSR Compressed or Compacted		–	–	–	874.5 36/1	874.5 36/1	874.5 36/1
	AWAC, ACAR		–	–	–	739.8 33/4, 30/7, 24/13, 18/19	739.8 33/4, 30/7, 24/13, 18/19	739.8 33/4, 30/7, 24/13, 18/19
	ALUMOWELD COPPERWELD		–	–	–	37 No. 7	37 No. 7	37 No. 7
	Galvanized Steel		–	–	–	1"	1"	1"
	Solid: AL or CU		–	–	–	–	–	–













S T R A N S M I T T E R	ACSR Standard Round		715.5 54/7, 45/7, 26/7, 24/7, 666.6 54/7, 26/7, 24/7, 795.0 36/1	795.0 54/7, 45/7, 30/19, 30/7, 26/7, 24/7, 874.5 45/7, 54/7, 715.5 30/19, 30/7	954.0 36/1, 900.0 45/7	6 6/1, 5 6/1	4 7/1, 6/1, 3 6/1	2 7/1, 6/1, 1 6/1, 80.0 8/1
	AAAC 6201-5003		833.6	927.2, 932.6	–	5, 6	3, 4	1, 2
	AAC Standard Round		795.0, 800.0	874.5, 900.0	954.0, 1000.0	4, 5, 6	2, 3	1/0, 1
	COPPER Standard Round		800.0	850.0, 900.0	1000.0	4, 5, 6	2, 3	1/0, 1
	AAC Compressed or Compacted		954.0	–	–	3, 4	1, 2	2/0, 1/0
	ACSR Compressed or Compacted		954.0 36/1	–	–	4 7/1, 6/1	2 7/1, 6/1	1/0, 1 6/1
	AWAC, ACAR		853.7 30/7, 24/13, 18/19, 862.7 18/19, 840.2 24/13, 819.2 30/7	927.2 30/7, 24/13, 18/19	1012.2 24/13, 983.1 30/7	4 6/1	2 6/1, 3 5/2, 6/1, 4 4/3, 5/2, 3/4	1/0 6/1, 1 5/2, 6/1, 2 4/3, 5/2, 3/4, 3 4/3, 2/5, 3/4, 4 2/5
	ALUMOWELD COPPERWELD		37 No. 7	37 No. 6	–	6A, 6C, 7A, 7D, 8A, 8D, 3 No. 10, 7 No. 12	2F, 4A, 5A, 5D, 6A, 3 No. 7, 3 No. 8, 3 No. 9, 7 No. 10, 7 No. 11	1/0F, 1F, 1G, 2A, 2G, 2J, 2K, 3A, 4D, 4N, 4P, 3 No. 6, 7 No. 8, 7 No. 9
	Galvanized Steel		–	–	–	1/4", 7/32", 3/16"	9/32"	3/8", 11/32", 5/16"
	Solid: AL or CU		–	–	–	3, 4	1, 2	2/0, 1/0

Use TAP Number 602121-2* 602121-1* 602121* I-602121-4* I-602121-3* 1-602121-2*

*UL Listed











S T R A N D E D	Large Wire Groove Code							
	ACSR Standard Round 	636.0 30/19, 30/7, 26/7, 24/7, 666.6 54/7, 26/7, 24/7, 715.5 45/7, 605.0 30/19, 30/7	636.0 30/19, 30/7, 26/7, 24/7, 666.6 54/7, 26/7, 24/7, 715.5 45/7, 605.0 30/19, 30/7	636.0 30/19, 30/7, 26/7, 24/7, 666.6 54/7, 26/7, 24/7, 715.5 45/7, 605.0 30/19, 30/7	636.0 30/19, 30/7, 26/7, 24/7, 666.6 54/7, 26/7, 24/7, 715.5 45/7, 605.0 30/19, 30/7	636.0 30/19, 30/7, 26/7, 24/7, 666.6 54/7, 26/7, 24/7, 715.5 45/7, 605.0 30/19, 30/7	636.0 30/19, 30/7, 26/7, 24/7, 666.6 54/7, 26/7, 24/7, 715.5 45/7, 605.0 30/19, 30/7	636.0 30/19, 30/7, 26/7, 24/7, 666.6 54/7, 26/7, 24/7, 715.5 45/7, 605.0 30/19, 30/7
	AAAC 6201-5003 	740.8, 746.1	740.8, 746.1	740.8, 746.1	740.8, 746.1	740.8, 746.1	740.8, 746.1	
	AAC Standard Round 	715.5, 750.0	715.5, 750.0	715.5, 750.0	715.5, 750.0	715.5, 750.0	715.5, 750.0	
	COPPER Standard Round 	750.0	750.0	750.0	750.0	750.0	750.0	
	AAC Compressed or Compacted 	874.5	874.5	874.5	874.5	874.5	874.5	
	ACSR Compressed or Compacted 	874.5 36/1	874.5 36/1	874.5 36/1	874.5 36/1	874.5 36/1	874.5 36/1	
	AWAC, ACAR 	739.8 33/4, 30/7, 24/13, 18/19	739.8 33/4, 30/7, 24/13, 18/19	739.8 33/4, 30/7, 24/13, 18/19	739.8 33/4, 30/7, 24/13, 18/19	739.8 33/4, 30/7, 24/13, 18/19	739.8 33/4, 30/7, 24/13, 18/19	
	ALUMOWELD COPPERWELD 	37 No. 7	37 No. 7	37 No. 7	37 No. 7	37 No. 7	37 No. 7	
	Galvanized Steel 	1"	1"	1"	1"	1"	1"	
Solid: AL or CU 	-	-	-	-	-	-		













S T R A N D E D	ACSR Standard Round 	1/0 6/1	3/0 6/1, 2/0 6/1, 101.8, 110.8 12/7	4/0 6/1, 134.6 12/7	266.8 26/7, 24/7, 18/1, 6/7, 176.9, 159.0, 190.8 12/7	336.4 26/7, 24/7, 18/1, 266.8 30/7, 211.3 12/7, 300.0 30/7, 26/7, 24/7, 18/1	97.52 6/7, 24/7, 18/1, 336.4 30/7, 203.2 16/19
	AAAC 6201-5003 	1/0	2/0, 3/0	4/0	281.4, 307.1, 312.8	355.1, 394.5	419.6, 465.4, 466.3
	AAC Standard Round 	2/0	3/0	4/0	250.0, 266.8, 300.0	336.4, 350.0	397.5, 400.0, 450.0
	COPPER Standard Round 	2/0	3/0	4/0	250.0, 300.0	350.0	400.0, 450.0
	AAC Compressed or Compacted 	3/0	4/0	250.0, 266.8	300.0, 336.4, 350.0	397.5, 477.0	500.0, 556.5
	ACSR Compressed or Compacted 	2/0 6/1	3/0 6/1	266.8 18/1, 4/0 6/1	336.4 18/1	397.5 18/1	477.0 18/1
	AWAC, ACAR 	2/0 6/1, 1/0 5/2, 1 3/4, 4/3, 2 2/5	3/0 6/1, 2/0 5/2, 1/0 4/3, 3/4, 12/5	4/0 6/1, 3/0 4/3, 5/2, 2/0 4/3, 3/4, 1/0 2/5	4/0 15/4	355.0 15/4, 12/7, 343.6 15/4, 336.4 16/3, 18/1	336.4 15/4
	ALUMOWELD COPPERWELD 	2/0 F, 1/0 G, 1/0 J, 1J, 1K, 2N, 7 No. 7, 3 No. 5	3/0F, 2/0G, 2/0J, 1/0K, 1N, 2P, 7 No. 6	4/0F, 2/0K, 19 No. 10, 7 No. 5	4/0 E, 4/0 G, 19 NO. 9, 7 No. 4	19 No. 8	37 No. 10, 19 No. 7
	Galvanized Steel 	7/16"	-	9/16", 1/2"	5/8"	-	3/4"
	Solid: AL or CU 	3/0	4/0	250.0, 266.8 300.0	336.4, 350.0, 397.5, 400.0	450.0, 477.0, 500.0	-

Use TAP Number 1-602121-1* 1-602121-0* 602121-9* 602121-8* 602121-7* 602121-6*

*UL Listed











Large Wire Groove Code							
S T R A N D E D	ACSR Standard Round 	636.0 30/19, 30/7, 26/7, 24/7, 666.6 54/7, 26/7, 24/7, 715.5 45/7, 605.0 30/19, 30/7	636.0 30/19, 30/7, 26/7, 24/7, 666.6 54/7, 26/7, 24/7, 715.5 45/7, 605.0 30/19, 30/7	636.0 30/19, 30/7, 26/7, 24/7, 666.6 54/7, 26/7, 24/7, 715.5 45/7, 605.0 30/19, 30/7	636.0 30/19, 30/7, 26/7, 24/7, 666.6 54/7, 26/7, 24/7, 715.5 45/7, 605.0 30/19, 30/7	636.0 30/19, 30/7, 26/7, 24/7, 666.6 54/7, 26/7, 24/7, 715.5 45/7, 605.0 30/19, 30/7	636.0 30/19, 30/7, 26/7, 24/7, 666.6 54/7, 26/7, 24/7, 715.5 45/7, 605.0 30/19, 30/7
	AAAC 6201-5003 	740.8, 746.1	740.8, 746.1	740.8, 746.1	740.8, 746.1	740.8, 746.1	740.8, 746.1
	AAC Standard Round 	715.5, 750.0	715.5, 750.0	715.5, 750.0	715.5, 750.0	715.5, 750.0	715.5, 750.0
	COPPER Standard Round 	750.0	750.0	750.0	750.0	750.0	750.0
	AAC Compressed or Compacted 	874.5	874.5	874.5	874.5	874.5	874.5
	ACSR Compressed or Compacted 	874.5 36/1	874.5 36/1	874.5 36/1	874.5 36/1	874.5 36/1	874.5 36/1
	AWAC, ACAR 	739.8 33/4, 30/7, 24/13, 18/19	739.8 33/4, 30/7, 24/13, 18/19	739.8 33/4, 30/7, 24/13, 18/19	739.8 33/4, 30/7, 24/13, 18/19	739.8 33/4, 30/7, 24/13, 18/19	739.8 33/4, 30/7, 24/13, 18/19
	ALUMOWELD COPPERWELD 	37 No. 7	37 No. 7	37 No. 7	37 No. 7	37 No. 7	37 No. 7
	Galvanized Steel 	1"	1"	1"	1"	1"	1"
	Solid: AL or CU 	-	-	-	-	-	-













S T R A N D E D	ACSR Standard Round 	477.0 26/7, 24/7, 18/1, 397.5 30/7	556.5 26/7, 24/7, 18/1, 477.0, 500.0 30/7	636.0 54/7, 26/7, 24/7, 36/1, 18/1, 605.0 54/7, 30/7, 26/7, 24/7, 556.5 30/7	666.6 54/7, 26/7, 24/7, 636.0 30/19, 30/7, 715.5 45/7	795.0 54/7, 45/7, 26/7, 24/7, 36/1, 715.5 54/7, 26/7, 24/7, 30/19, 30/7	795.0 30/7, 30/19, 954.0 36/1, 900.0 45/7, 874.5 54/7, 45/7
	AAAC 6201-5003 	503.6	559.5, 587.2, 599.6	652.4, 652.8, 704.6, 740.8	-	833.6	927.2, 932.6
	AAC Standard Round 	477.0, 500.0	550.0, 556.5, 600.0	636.0, 650.0, 715.5, 700.0	750.0	795.0, 800.0, 874.5, 900.0	954.0, 1000.0
	COPPER Standard Round 	500.0	550.0, 600.0	650.0, 700.0	750.0	800.0, 850.0, 900.0	1000.0
	AAC Compressed or Compacted 	636.0	-	795.0, 874.5	-	954.0	-
	ACSR Compressed or Compacted 	556.5 18/1	636.0 18/1	874.5, 795.0 36/1	-	954.0 36/1	-
	AWAC, ACAR 	503.6 15/4, 12/7	653.1 15/4, 12/7, 568.3 15/4	739.8 30/7, 33/4, 24/3, 18/9	-	853.7 30/7, 24/13, 18/19, 862.7 18/19, 840.2 24/13, 819.2 30/7	1012.2 24/13, 983.1 30/7, 927.2 30/7, 24/13, 18/19
	ALUMOWELD COPPERWELD 	19 No. 6, 37 No. 9	37 No. 8, 19 No. 5	-	37 No. 7	-	37 No. 6
	Galvanized Steel 	-	7/8"	-	1"	-	-
	Solid: AL or CU 	-	-	-	-	-	-

Use TAP Number 602121-5* 602121-4* 602121-3* 602121-2* 602121-1* 602121*

*UL Listed











Large Wire Groove Code								
S T R A N D E D	ACSR Standard Round 	795.0 54/7, 45/7, 26/7, 24/7, 36/1, 715.5 54/7, 30/19, 30/7, 26/7, 24/7	795.0 54/7, 45/7, 26/7, 24/7, 36/1, 715.5 54/7, 30/19, 30/7, 26/7, 24/7	795.0 54/7, 45/7, 26/7, 24/7, 36/1, 715.5 54/7, 30/19, 30/7, 26/7, 24/7	795.0 54/7, 45/7, 26/7, 24/7, 36/1, 715.5 54/7, 30/19, 30/7, 26/7, 24/7	795.0 54/7, 45/7, 26/7, 24/7, 36/1, 715.5 54/7, 30/19, 30/7, 26/7, 24/7	795.0 54/7, 45/7, 26/7, 24/7, 36/1, 715.5 54/7, 30/19, 30/7, 26/7, 24/7	
	AAAC 6201-5003 	833.6, 927.2, 932.6	833.6, 927.2, 932.6	833.6, 927.2, 932.6	833.6, 927.2, 932.6	833.6, 927.2, 932.6	833.6, 927.2, 932.6	833.6, 927.2, 932.6
	AAC Standard Round 	795.0, 800.0 874.5, 900.0	795.0, 800.0 874.5, 900.0	795.0, 800.0 874.5, 900.0	795.0, 800.0 874.5, 900.0	795.0, 800.0 874.5, 900.0	795.0, 800.0 874.5, 900.0	795.0, 800.0 874.5, 900.0
	COPPER Standard Round 	800.0 850.0, 900.0	800.0 850.0, 900.0	800.0 850.0, 900.0	800.0 850.0, 900.0	800.0 850.0, 900.0	800.0 850.0, 900.0	800.0 850.0, 900.0
	AAC Compressed or Compacted 	954.0	954.0	954.0	954.0	954.0	954.0	954.0
	ACSR Compressed or Compacted 	954.0 36/1	954.0 36/1	954.0 36/1	954.0 36/1	954.0 36/1	954.0 36/1	954.0 36/1
	AWAC, ACAR 	853.7, 927.2 30/7, 24/13, 18/19, 862.7 18/19, 840.2 24/13, 819.2 30/7	853.7, 927.2 30/7, 24/13, 18/19, 862.7 18/19, 840.2 24/13, 819.2 30/7	853.7, 927.2 30/7, 24/13, 18/19, 862.7 18/19, 840.2 24/13, 819.2 30/7	853.7, 927.2 30/7, 24/13, 18/19, 862.7 18/19, 840.2 24/13, 819.2 30/7	853.7, 927.2 30/7, 24/13, 18/19, 862.7 18/19, 840.2 24/13, 819.2 30/7	853.7, 927.2 30/7, 24/13, 18/19, 862.7 18/19, 840.2 24/13, 819.2 30/7	853.7, 927.2 30/7, 24/13, 18/19, 862.7 18/19, 840.2 24/13, 819.2 30/7
	ALUMOWELD COPPERWELD 	—	—	—	—	—	—	—
	Galvanized Steel 	—	—	—	—	—	—	—
	Solid: AL or CU 	—	—	—	—	—	—	—













S T R A N D E D	ACSR Standard Round 	6 6/1	4 7/1, 6/1, 5 6/1	2 7/1, 6/1, 3 6/1	1/0 6/1, 1 6/1, 80.0 8/1	2/0 6/1	3/0 6/1, 101.8, 110.8 12/7
	AAAC 6201-5003 	6	4, 5	2, 3	1/0, 1	2/0	3/0
	AAC Standard Round 	6	3, 4, 5	1, 2	1/0	2/0	3/0
	COPPER Standard Round 	6	3, 4, 5	1, 2	1/0	2/0	3/0
	AAC Compressed or Compacted 	6	3, 4	2	2/0, 1/0	3/0	4/0
	ACSR Compressed or Compacted 	6 6/1	4 7/1, 6/1	1 6/1, 2 7/1, 6/1	1/0 6/1	2/0 6/1	3/0 6/1
	AWAC, ACAR 	—	4 5/2, 6/1	2 5/2, 6/1, 3 4/3, 5/2, 6/1, 4 3/4, 4/3	1/0 6/1, 1 5/2, 6/1, 2 4/3, 3/4, 3 2/5, 3/4, 4 2/5	2/0 6/1, 1/0 5/2, 4/3, 1 3/4, 4/3, 2 2/5	3/0 6/1, 2/0 5/2, 1/0 3/4, 1 2/5
	ALUMOWELD COPPERWELD 	8A, 8C 3 No. 12	5A, 6A, 6C, 7A, 7D, 8D, 7 No. 12, 3 No. 9, 3 No. 10	2F, 2G, 3A, 4A, 4N, 5D, 6D, 3 No. 7, 3 No. 8, 7 No. 10, 7 No. 11	1/0 F, 1F, 1G, 1J, 2A, 2J, 2K, 4D, 4P, 3 No. 5, 3 No. 6, 7 No. 8, 7 No. 9	2/0F, 1/0G, 1/0F, 1K, 2N, 7 No. 7	3/0F, 2/0G, 2/0J, 1/0K, 1N, 2P, 7 No. 6
	Galvanized Steel 	3/16"	1/4", 7/32"	5/16", 9/32"	3/8", 11/32"	7/16"	1/2"
	Solid: AL or CU 	5, 6	2, 3, 4	1/0, 1	2/0	3/0	250.0, 4/0

Use TAP Number 1-602121-4* 1-602121-3* 1-602121-2* 1-602121-1* 1-602121-0* 602121-9*

*UL Listed

Large Wire Groove Code							
S T R A N D E D	ACSR Standard Round		795.0 54/7, 45/7, 26/7, 24/7, 36/1, 715.5 54/7, 30/19, 30/7, 26/7, 24/7	795.0 54/7, 45/7, 26/7, 24/7, 36/1, 715.5 54/7, 30/19, 30/7, 26/7, 24/7	795.0 54/7, 45/7, 26/7, 24/7, 36/1, 715.5 54/7, 30/19, 30/7, 26/7, 24/7	795.0 54/7, 45/7, 26/7, 24/7, 36/1, 715.5 54/7, 30/19, 30/7, 26/7, 24/7	795.0 54/7, 45/7, 26/7, 24/7, 36/1, 715.5 54/7, 30/19, 30/7, 26/7, 24/7
	AAAC 6201-5003		833.6, 927.2, 932.6	833.6, 927.2, 932.6	833.6, 927.2, 932.6	833.6, 927.2, 932.6	833.6, 927.2, 932.6
	AAC Standard Round		795.0, 800.0 874.5, 900.0	795.0, 800.0 874.5, 900.0	795.0, 800.0 874.5, 900.0	795.0, 800.0 874.5, 900.0	795.0, 800.0 874.5, 900.0
	COPPER Standard Round		800.0 850.0, 900.0	800.0 850.0, 900.0	800.0 850.0, 900.0	800.0 850.0, 900.0	800.0 850.0, 900.0
	AAC Compressed or Compacted		954.0	954.0	954.0	954.0	954.0
	ACSR Compressed or Compacted		954.0 36/1	954.0 36/1	954.0 36/1	954.0 36/1	954.0 36/1
	AWAC, ACAR		853.7, 927.2 30/7, 24/13, 18/19, 862.7 18/19, 840.2 24/13, 819.2 30/7	853.7, 927.2 30/7, 24/13, 18/19, 862.7 18/19, 840.2 24/13, 819.2 30/7	853.7, 927.2 30/7, 24/13, 18/19, 862.7 18/19, 840.2 24/13, 819.2 30/7	853.7, 927.2 30/7, 24/13, 18/19, 862.7 18/19, 840.2 24/13, 819.2 30/7	853.7, 927.2 30/7, 24/13, 18/19, 862.7 18/19, 840.2 24/13, 819.2 30/7
	ALUMOWELD COPPERWELD		–	–	–	–	–
	Galvanized Steel		–	–	–	–	–
	Solid: AL or CU		–	–	–	–	–













S T R A N D E D	ACSR Standard Round		4/0 6/1, 134.6 12/7	266.8 26/7, 24/7, 18/1, 6/7, 300.0 18/1, 159.0, 190.8, 176.9 12/7	336.4 26/7, 24/7, 18/1, 300.0 30/7, 26/7, 24/7, 266.8 30/7, 211.3 12/7, 203.2 16/19	397.5 26/7, 24/7, 18/1, 336.4 30/7	477.0 26/7, 24/7, 18/1, 397.5 30/7	556.5 26/7, 18/1, 24/7, 477.0, 500.0 30/7
	AAAC 6201-5003		4/0	281.4, 307.1, 312.8	355.1, 394.5	419.6, 465.4, 466.3	503.6, 559.5, 599.6	587.2, 652.4, 652.8
	AAC Standard Round		4/0	250.0, 266.8, 300.0	336.4, 350.0	397.5, 400.0, 450.0, 477.0	500.0, 550.0	556.5, 600.0
	COPPER Standard Round		4/0	250.0, 300.0	350.0	400.0, 450.0	500.0, 550.0	600.0
	AAC Compressed or Compacted		250.0, 266.8	300.0, 336.4, 350.0	397.5	477.0, 500.0 556.5	636.0	–
	ACSR Compressed or Compacted		266.8 18/1, 4/0 6/1	336/4 18/1	397.5 18/1	477.0, 556.6 18/1	–	636.0 18/1
	AWAC, ACAR		4/0 6/1, 3/0 4/3, 5/2, 2/0 4/3, 3/4, 1/0 2/5	4/0 15/4	355.0 15/4, 12/7 343.6 15/4, 336.4 16/3, 18/1	336.4 15/4	503.6 15/4, 12/7	653.1 15/4, 12/7, 568.3 15/4
	ALUMOWELD COPPERWELD		4/0F, 2/0K, 19 No. 10, 7 No. 5	19 No. 8, 19 No. 9, 7 No. 4, 4/0E, 4/0G	37 No. 10, 19 No. 7	37 No. 9	19 No. 6	37 No. 8 19 No. 5
	Galvanized Steel		9/16"	5/8"	–	3/4"	–	7/8"
	Solid: AL or CU		266.8, 300.0	336.4, 350.0, 397.5, 400.0	450.0, 477.0, 500.0	–	–	–











Use TAP Number 602121-8* 602121-7* 602121-6* 602121-5* 602121-4* 602121-3*

*UL Listed



Large Wire Groove Code							
S T R A N D E D	ACSR Standard Round 	795.0 54/7, 45/7, 26/7, 24/7, 36/1, 715.5 54/7, 30/19, 30/7, 26/7, 24/7	795.0 54/7, 45/7, 26/7, 24/7, 36/1, 715.5 54/7, 30/19, 30/7, 26/7, 24/7	795.0 54/7, 45/7, 26/7, 24/7, 36/1, 715.5 54/7, 30/19, 30/7, 26/7, 24/7	954.0 45/7, 36/1, 900.0 54/7, 45/7, 874.5 54/7, 795.0 30/7, 30/19	954.0 45/7, 36/1, 900.0 54/7, 45/7, 874.5 54/7, 795.0 30/7, 30/19	954.0 45/7, 36/1, 900.0 54/7, 45/7, 874.5 54/7, 795.0 30/7, 30/19
	AAAC 6201-5003 	833.6, 927.2, 932.6	833.6, 927.2, 932.6	833.6, 927.2, 932.6	-	-	-
	AAC Standard Round 	795.0, 800.0, 874.5, 900.0	795.0, 800.0, 874.5, 900.0	795.0, 800.0, 874.5, 900.0	954.0, 1000.0	954.0, 1000.0	954.0, 1000.0
	COPPER Standard Round 	800.0, 850.0, 900.0	800.0, 850.0, 900.0	800.0, 850.0, 900.0	1000.0	1000.0	1000.0
	AAC Compressed or Compacted 	954.0	954.0	954.0	-	-	-
	ACSR Compressed or Compacted 	954.0 36/1	954.0 36/1	954.0 36/1	-	-	-
	AWAC, ACAR 	853.7, 927.2 30/7, 24/13, 18/19, 862.7 18/19, 840.2 24/13, 819.2 30/7	853.7, 927.2 30/7, 24/13, 18/19, 862.7 18/19, 840.2 24/13, 819.2 30/7	853.7, 927.2 30/7, 24/13, 18/19, 862.7 18/19, 840.2 24/13, 819.2 30/7	1024.5 30/7, 24/13, 18/19, 1012.2 24/13, 983.1 30/7	1024.5 30/7, 24/13, 18/19, 1012.2 24/13, 983.1 30/7	1024.5 30/7, 24/13, 18/19, 1012.2 24/13, 983.1 30/7
	ALUMOWELD COPPERWELD 	-	-	-	37 No. 6	37 No. 6	37 No. 6
	Galvanized Steel 	-	-	-	-	-	-
	Solid: AL or CU 	-	-	-	-	-	-



S T R A N D E D	ACSR Standard Round 	636.0 54/7, 26/7, 24/7, 36/1, 18/1, 605.0 54/7, 26/7, 24/7, 30/19, 30/7, 556.5 30/7, 653.9 18/3	715.5 54/7, 45/7, 26/7, 24/7, 795.0 36/1, 666.6 54/7, 26/7, 24/7, 636.0 30/19, 30/7	795.0 54/7, 45/7, 26/7, 24/7, 715.5 30/19, 30/7	6 6/1	4 7/1, 6/1, 5 6/1	1 6/1, 2 7/1, 6/1
	AAAC 6201-5003 	704.6	740.8, 746.1, 833.6	927.2	6	4, 5	1, 2, 3
	AAC Standard Round 	636.0, 650.0, 700.0, 795.0	715.5, 750.0, 795.0	800.0, 874.5, 900.0	5, 6	3, 4	1, 2
	COPPER Standard Round 	650.0, 700.0	750.0	-	5, 6	3, 4	1, 2
	AAC Compressed or Compacted 	795.0	874.5, 954.0	-	4, 6	2, 3	1/0, 1
	ACSR Compressed or Compacted 	795.0 36/1	874.5, 954.0 36/1	-	6 6/1	4 7/1, 6/1	1 6/1, 2 7/1, 6/1
	AWAC, ACAR 	-	819.2 30/7, 739.8 33/4, 30/7, 24/13, 18/9	853.7, 927.2 30/7, 24/13, 18/19, 862.7 18/19, 840.2 23/13	-	4 5/2, 6/1	1 6/1, 2 4/3, 5/2, 6/1, 3 3/4, 4/3, 5/2, 6/1, 4 2/5, 3/4, 4/3
	ALUMOWELD COPPERWELD 	-	37 No. 7	-	8A, 8C, 3 No. 12	5A, 6A, 6C, 7A, 7D, 8D, 3 No. 9, 3 No. 10, 7 No. 11, 7 No. 12	1F, 2F, 2G, 2J, 3A, 4A, 4D, 4N, 5D, 6D, 3 No. 6, 3 No. 7, 3 No. 8, 7 No. 9, 7 No. 10
	Galvanized Steel 	-	1"	-	3/16"	7/32", 9/32", 1/4"	3/8", 5/16", 9/32", 11/32"
	Solid: AL or CU 	-	-	-	4, 5, 6	2, 3	1/0, 1

Use TAP Number 602121-2* 602121-1* 602121* 1-602180-6* 1-602180-5* 1-602180-4*

*UL Listed













Large Wire Groove Code							
S T R A N S M I T T E R	ACSR Standard Round	954.0 45/7, 36/1, 900.0 54/7, 45/7, 874.5 54/7, 795.0 30/7, 30/19	954.0 45/7, 36/1, 900.0 54/7, 45/7, 874.5 54/7, 795.0 30/7, 30/19	954.0 45/7, 36/1, 900.0 54/7, 45/7, 874.5 54/7, 795.0 30/7, 30/19	954.0 45/7, 36/1, 900.0 54/7, 45/7, 874.5 54/7, 795.0 30/7, 30/19	954.0 45/7, 36/1, 900.0 54/7, 45/7, 874.5 54/7, 795.0 30/7, 30/19	954.0 45/7, 36/1, 900.0 54/7, 45/7, 874.5 54/7, 795.0 30/7, 30/19
	AAAC 6201-5003	–	–	–	–	–	–
	AAC Standard Round	954.0, 1000.0	954.0, 1000.0	954.0, 1000.0	954.0, 1000.0	954.0, 1000.0	954.0, 1000.0
	COPPER Standard Round	1000.0	1000.0	1000.0	1000.0	1000.0	1000.0
	AAC Compressed or Compacted	–	–	–	–	–	–
	ACSR Compressed or Compacted	–	–	–	–	–	–
	AWAC, ACAR	1024.5 30/7, 24/13, 18/19, 1012.2 24/13, 983.1 30/7	1024.5 30/7, 24/13, 18/19, 1012.2 24/13, 983.1 30/7	1024.5 30/7, 24/13, 18/19, 1012.2 24/13, 983.1 30/7	1024.5 30/7, 24/13, 18/19, 1012.2 24/13, 983.1 30/7	1024.5 30/7, 24/13, 18/19, 1012.2 24/13, 983.1 30/7	1024.5 30/7, 24/13, 18/19, 1012.2 24/13, 983.1 30/7
	ALUMOWELD COPPERWELD	37 No. 6	37 No. 6	37 No. 6	37 No. 6	37 No. 6	37 No. 6
	Galvanized Steel	–	–	–	–	–	–
	Solid: AL or CU	–	–	–	–	–	–













S T R A N S M I T T E R	ACSR Standard Round	2/0 6/1, 1/0 6/1, 80.0 8/1	3/0 6/1, 101.8 12/7	4/0 6/1, 110.8, 134.6 12/7	266.8 18/1, 159.0, 176.9 12/7	336.4 26/7, 24/7, 18/1, 300.0 30/7, 26/7, 24/7, 18/1, 266.8 30/7, 26/7, 24/7, 6/7, 211.3 12/7, 190.8 12/7	397.5 18/1, 336.4 30/7, 203.2 16/19
	AAAC 6201-5003	2/0, 1/0	3/0	4/0	281.4	307.1, 312.8, 355.1	394.5, 419.6
	AAC Standard Round	2/0, 1/0	3/0	4/0	250.0, 266.8	300.0, 336.4, 350.0	397.5, 400.0
	COPPER Standard Round	2/0, 1/0	3/0	4/0	250.0	300.0, 350.0	400.0
	AAC Compressed or Compacted	2/0	3/0	250.0, 4/0	266.8, 300.0, 336.4	350.0, 397.5	477.0, 500.0
	ACSR Compressed or Compacted	2/0, 1/0 6/1	3/0 6/1	4/0 6/1	266.8 18/1	336.4 18/1, 397.5 18/1	477.0 18/1
	AWAC, ACAR	1/0 6/1, 1 4/3, 5/2, 2 3/4, 3 2/5	2/0 6/1, 1/0 4/3, 5/2, 1 3/4, 2 2/5	3/0 6/1, 5/2, 2/0 4/3, 5/2, 1/0 3/4, 1 2/5	4/0 15/4, 6/1, 3/0 4/3, 2/0 3/4, 1/0 2/5	336.4 18/1, 343.6 15/4, 355.0 15/4, 12/7	336.4 16/3, 15/4
	ALUMOWELD COPPERWELD	4P, 1/0F, 1/0G, 1G, 1J, 1K, 2A, 2K, 2N, 3 No. 5, 7 No. 8	2/0F, 2/0G, 1/0J, 1N, 2P, 7 No. 7	3/0F, 2/0J, 2/0K, 1/0K, 7 No. 6, 19 No. 10	4/0F, 4/0G, 7 No. 5, 19 No. 9	4/0E, 7 No. 4, 19 No. 8	19 No. 7, 37 No. 10
	Galvanized Steel	–	7/16"	1/2"	9/16"	5/8"	–
	Solid: AL or CU	3/0, 2/0	4/0	250.0, 266.8, 300.0	336.4, 350.0, 397.5	400.0, 450.0, 477.0	500.0

Use TAP Number 1-602180-3* 1-602180-2* 1-602180-1* 1-602180-0* 602180-9* 602180-8*

*UL Listed











Large Wire Groove Code							
S T R A N S M I T T E R	ACSR Standard Round 	954.0 45/7, 36/1, 900.0 54/7, 45/7, 874.5 54/7, 795.0 30/7, 30/19	954.0 45/7, 36/1, 900.0 54/7, 45/7, 874.5 54/7, 795.0 30/7, 30/19	954.0 45/7, 36/1, 900.0 54/7, 45/7, 874.5 54/7, 795.0 30/7, 30/19	954.0 45/7, 36/1, 900.0 54/7, 45/7, 874.5 54/7, 795.0 30/7, 30/19	954.0 45/7, 36/1, 900.0 54/7, 45/7, 874.5 54/7, 795.0 30/7, 30/19	954.0 45/7, 36/1, 900.0 54/7, 45/7, 874.5 54/7, 795.0 30/7, 30/19
	AAAC 6201-5003 	–	–	–	–	–	–
	AAC Standard Round 	954.0, 1000.0	954.0, 1000.0	954.0, 1000.0	954.0, 1000.0	954.0, 1000.0	954.0, 1000.0
	COPPER Standard Round 	1000.0	1000.0	1000.0	1000.0	1000.0	1000.0
	AAC Compressed or Compacted 	–	–	–	–	–	–
	ACSR Compressed or Compacted 	–	–	–	–	–	–
	AWAC, ACAR 	1024.5 30/7, 24/13, 18/19, 1012.2 24/13, 983.1 30/7	1024.5 30/7, 24/13, 18/19, 1012.2 24/13, 983.1 30/7	1024.5 30/7, 24/13, 18/19, 1012.2 24/13, 983.1 30/7	1024.5 30/7, 24/13, 18/19, 1012.2 24/13, 983.1 30/7	1024.5 30/7, 24/13, 18/19, 1012.2 24/13, 983.1 30/7	1024.5 30/7, 24/13, 18/19, 1012.2 24/13, 983.1 30/7
	ALUMOWELD COPPERWELD 	37 No. 6	37 No. 6	37 No. 6	37 No. 6	37 No. 6	37 No. 6
	Galvanized Steel 	–	–	–	–	–	–
	Solid: AL or CU 	–	–	–	–	–	–













S T R A N S M I T T E R	ACSR Standard Round 	477.0 26/7, 24/7, 18/1, 397.5 30/7, 26/7, 24/7	556.5 18/1, 477.0, 500.0 30/7	636.0 54/7, 36/1, 26/7, 24/7, 18/1, 605.0 54/7, 30/19, 30/7, 26/7, 24/7, 556.6 30/7, 26/7, 24/7, 653.9 18/3	715.5 45/7, 666.6 54/7, 26/7, 24/7, 636.0 30/19, 30/7	795.0 45/7, 36/1, 715.5 54/7, 30/19, 30/7, 26/7, 24/7	874.5 54/7, 45/7, 795.0 54/7, 30/19, 30/7, 26/7, 24/7
	AAAC 6201-5003 	465.4, 466.3, 503.6	559.5, 587.2, 599.6	652.4, 652.8, 704.6	740.8, 746.1	833.6	927.2, 932.6
	AAC Standard Round 	450.0, 477.0, 500.0	550.0, 556.5, 600.0	636.0, 650.0, 700.0	715.5, 750.0	795.0, 800.0, 874.5	900.0, 954.0
	COPPER Standard Round 	450.0, 500.0, 550.0	600.0	650.0, 700.0	750.0	800.0, 850.0	900.0
	AAC Compressed or Compacted 	556.5	636.0	795.0	874.5	954.0	–
	ACSR Compressed or Compacted 	556.5 18/1	636.0 18/1	795.0 36/1	874.5 36/1	954.0 36/1	–
	AWAC, ACAR 	503.6 15/4, 12/7	568.3 15/4	653.1 15/4, 12/7	739.8 33/4, 30/7, 24/13, 18/19	819.2 30/7, 840.2 24/13, 853.7 30/7, 24/13, 18/19, 862.7 18/19, 927.2 30/7, 24/13, 18/19	1024.5 30/7, 24/13, 18/19, 1012.2 24/13, 983.1 30/7
	ALUMOWELD COPPERWELD 	19 No. 6, 37 No. 9	37 No. 8	19 No. 5	37 No. 7	–	37 No. 6
	Galvanized Steel 	3/4"	7/8"	–	1"	–	–
	Solid: AL or CU 	–	–	–	–	–	–

Use TAP Number 602180-7* 602180-6* 602180-5* 602180-4* 602180-3* 602180-2*

*UL Listed

Large Wire Groove Code							
S T R A N D E D	ACSR Standard Round 	954.0 45/7, 36/1, 900.0 54/7, 45/7, 874.5 54/7, 795.0 30/7, 30/19	954.0 45/7, 36/1, 900.0 54/7, 45/7, 874.5 54/7, 795.0 30/7, 30/19	1033.5 54/7, 45/7, 36/1, 954.0 54/7, 30/7	1033.5 54/7, 45/7, 36/1, 954.0 54/7, 30/7	1033.5 54/7, 45/7, 36/1, 954.0 54/7, 30/7	1033.5 54/7, 45/7, 36/1, 954.0 54/7, 30/7
	AAAC 6201-5003 	–	–	–	–	–	–
	AAC Standard Round 	954.0, 1000.0	954.0, 1000.0	1033.5, 1110.0, 1113.0	1033.5, 1110.0, 1113.0	1033.5, 1110.0, 1113.0	1033.5, 1110.0, 1113.0
	COPPER Standard Round 	1000.0	1000.0	–	–	–	–
	AAC Compressed or Compacted 	–	–	–	–	–	–
	ACSR Compressed or Compacted 	–	–	–	–	–	–
	AWAC, ACAR 	1024.5 30/7, 24/13, 18/19, 1012.2 24/13, 983.1 30/7	1024.5 30/7, 24/13, 18/19, 1012.2 24/13, 983.1 30/7	1172.0 30/7, 24/13, 18/19, 33/4, 1081.0, 1109.0 30/7, 24/13, 18/19	1172.0 30/7, 24/13, 18/19, 33/4, 1081.0, 1109.0 30/7, 24/13, 18/19	1172.0 30/7, 24/13, 18/19, 33/4, 1081.0, 1109.0 30/7, 24/13, 18/19	1172.0 30/7, 24/13, 18/19, 33/4, 1081.0, 1109.0 30/7, 24/13, 18/19
	ALUMOWELD COPPERWELD 	37 No. 6	37 No. 6	–	–	–	–
	Galvanized Steel 	–	–	–	–	–	–
	Solid: AL or CU 	–	–	–	–	–	–



S T R A N D E D	ACSR Standard Round 	1033.5 54/7, 45/7, 36/1, 954.0 54/7, 45/7, 36/1, 30/7, 900.0 54/7, 45/7	1033.5 54/7, 45/7, 954.0 30/7	6 6/1	4 7/1, 6/1, 5 6/1	2 7/1, 6/1, 3 6/1	1/0 6/1, 1 6/1, 80.0 8/1
	AAAC 6201-5003 	–	–	6	4, 5	2, 3	1/0, 1
	AAC Standard Round 	1000.0, 1033.5, 1100.0, 1113.0	1113.0, 1100.0	6	4, 5	2, 3	1/0, 1
	COPPER Standard Round 	1000.0	–	6	4, 5	2, 3	1/0, 1
	AAC Compressed or Compacted 	–	–	6	3, 4	1, 2	1/0
	ACSR Compressed or Compacted 	–	–	6 6/1	4 7/1, 6/1	2 7/1, 6/1	1/0 6/1, 1 6/1
	AWAC, ACAR 	1172.0 33/4, 30/7, 24/13, 18/19, 1081.0, 1109.0 30/7, 24/13, 18/19	1172.0 33/4, 30/7, 24/13, 18/19, 1109.0 30/7, 24/13, 18/19	–	–	2 6/1, 3 4/3, 5/2, 6/1, 4 4/3, 5/2, 3/4, 6/1	1 5/2, 6/1, 3 3/4, 2 4/3, 5/2, 4 2/5
	ALUMOWELD COPPERWELD 	–	–	8A, 8C, 3 No. 12	6A, 6C, 7A, 7D, 8D, 3 No. 9, 3 No. 10, 7 No. 12	2F, 4A, 5A, 5D, 6D, 3 No. 7, 3 No. 8, 7 No. 10, 7 No. 11	1F, 1G, 2A, 2G, 2J, 2K, 3A, 4D, 4N, 4P, 3 No. 6, 7 No. 9
	Galvanized Steel 	–	–	–	1/4", 7/32", 3/16"	5/16", 9/32"	11/32", 3/8"
	Solid: AL or CU 	–	–	5, 6	2, 3, 4	1/0, 1	2/0

Use TAP Number 602180-1* 602180* 1-602180-6* 1-602180-5* 1-602180-4* 1-602180-3*

*UL Listed

Large Wire Groove Code							
S T R A N S M I T T E R	ACSR Standard Round	1033.5 54/7, 45/7, 36/1, 954.0 54/7, 30/7	1033.5 54/7, 45/7, 36/1, 954.0 54/7, 30/7	1033.5 54/7, 45/7, 36/1, 954.0 54/7, 30/7	1033.5 54/7, 45/7, 36/1, 954.0 54/7, 30/7	1033.5 54/7, 45/7, 36/1, 954.0 54/7, 30/7	1033.5 54/7, 45/7, 36/1, 954.0 54/7, 30/7
	AAAC 6201-5003	–	–	–	–	–	–
	AAC Standard Round	1033.5, 1110.0, 1113.0	1033.5, 1110.0, 1113.0	1033.5, 1110.0, 1113.0	1033.5, 1110.0, 1113.0	1033.5, 1110.0, 1113.0	1033.5, 1110.0, 1113.0
	COPPER Standard Round	–	–	–	–	–	–
	AAC Compressed or Compacted	–	–	–	–	–	–
	ACSR Compressed or Compacted	–	–	–	–	–	–
	AWAC, ACAR	1172.0 30/7, 24/13, 18/19, 33/4, 1081.0, 1109.0 30/7, 24/13, 18/19	1172.0 30/7, 24/13, 18/19, 33/4, 1081.0, 1109.0 30/7, 24/13, 18/19	1172.0 30/7, 24/13, 18/19, 33/4, 1081.0, 1109.0 30/7, 24/13, 18/19	1172.0 30/7, 24/13, 18/19, 33/4, 1081.0, 1109.0 30/7, 24/13, 18/19	1172.0 30/7, 24/13, 18/19, 33/4, 1081.0, 1109.0 30/7, 24/13, 18/19	1172.0 30/7, 24/13, 18/19, 33/4, 1081.0, 1109.0 30/7, 24/13, 18/19
	ALUMOWELD COPPERWELD	–	–	–	–	–	–
	Galvanized Steel	–	–	–	–	–	–
	Solid: AL or CU	–	–	–	–	–	–



S T R A N S M I T T E R	ACSR Standard Round	2/0 6/1	3/0 6/1, 101.8 12/7	4/0 6/1, 110.8, 134.6 12/7	266.8 26/7, 24/7, 18/1, 6/7, 159.0, 176.9, 190.8 12/7	336.4 26/7, 24/7, 18/1, 300.0 30/7, 26/7, 24/7, 18/1, 266.8 30/7, 211.3 12/7, 203.2 16/19	397.5 26/7, 24/7, 18/1, 336.4 30/7
	AAAC 6201-5003	2/0	3/0	4/0	281.4, 307.1, 312.8	355.1, 394.5	419.6, 465.4, 466.3
	AAC Standard Round	2/0	3/0	4/0	250.0, 266.8, 300.0	336.4, 350.0	397.5, 400.0, 450.0
	COPPER Standard Round	2/0	3/0	4/0	250.0, 300.0	350.0	350.0, 400.0, 450.0
	AAC Compressed or Compacted	2/0	3/0	250.0, 266.8, 4/0	300.0, 336.4, 350.0	397.5	477.0, 500.0, 556.5
	ACSR Compressed or Compacted	2/0 6/1	3/0 6/1	4/0 6/1	266.8 18/1, 336.4 18/1	397.5 18/1	477.0 18/1
	AWAC, ACAR	1/0 5/2, 6/1, 1 4/3, 2 3/4, 3 2/5	3/0 6/1, 2/0 6/1, 5/2, 4/3, 1/0 4/3, 3/4, 1 3/4, 2/5, 2 2/5	4/0 6/1, 3/0 4/3, 5/2, 2/0 3/4, 1/0 2/5	4/0 15/4	343.6 15/4, 336.4 18/1, 16/3	336.4 15/4
	ALUMOWELD COPPERWELD	1/0F, 1/0G, 1J, 1K, 2N, 3 No.5, 7 No. 8	2/0J, 2/0G, 2/0F, 1/0K, 1/0J, 1N, 2P, 7 No. 6, 7 No. 7	4/0F, 3/0F, 2/0K, 7 No. 5, 19 No. 10	4/0E, 4/0G, 7 No. 4, 19. No. 9	19 No. 8	19 No. 7, 37 No. 10
	Galvanized Steel	–	1/2", 7/16"	9/16"	5/8"	–	3/4"
	Solid: AL or CU	3/0	4/0	250.0, 266.8, 300.0	336.4, 350.0, 397.5, 400.0	477.0, 450.0	500.0

Use TAP Number **1-602180-2*** **1-602180-1*** **1-602180-0*** **602180-9*** **602180-8*** **602180-7***

*UL Listed













Large Wire Groove Code							
S T R A N D E D	ACSR Standard Round	1033.5 54/7, 45/7, 36/1, 954.0 54/7, 30/7	1033.5 54/7, 45/7, 36/1, 954.0 54/7, 30/7	1033.5 54/7, 45/7, 36/1, 954.0 54/7, 30/7	1033.5 54/7, 45/7, 36/1, 954.0 54/7, 30/7	1033.5 54/7, 45/7, 36/1, 954.0 54/7, 30/7	1033.5 54/7, 45/7, 36/1, 954.0 54/7, 30/7
	AAAC 6201-5003	–	–	–	–	–	–
	AAC Standard Round	1033.5, 1110.0, 1113.0	1033.5, 1110.0, 1113.0	1033.5, 1110.0, 1113.0	1033.5, 1110.0, 1113.0	1033.5, 1110.0, 1113.0	1033.5, 1110.0, 1113.0
	COPPER Standard Round	–	–	–	–	–	–
	AAC Compressed or Compacted	–	–	–	–	–	–
	ACSR Compressed or Compacted	–	–	–	–	–	–
	AWAC, ACAR	1172.0 30/7, 24/13, 18/19, 33/4, 1081.0, 1109.0 30/7, 24/13, 18/19	1172.0 30/7, 24/13, 18/19, 33/4, 1081.0, 1109.0 30/7, 24/13, 18/19	1172.0 30/7, 24/13, 18/19, 33/4, 1081.0, 1109.0 30/7, 24/13, 18/19	1172.0 30/7, 24/13, 18/19, 33/4, 1081.0, 1109.0 30/7, 24/13, 18/19	1172.0 30/7, 24/13, 18/19, 33/4, 1081.0, 1109.0 30/7, 24/13, 18/19	1172.0 30/7, 24/13, 18/19, 33/4, 1081.0, 1109.0 30/7, 24/13, 18/19
	ALUMOWELD COPPERWELD	–	–	–	–	–	–
	Galvanized Steel	–	–	–	–	–	–
	Solid: AL or CU	–	–	–	–	–	–













S T R A N D E D	ACSR Standard Round	477.0 26/7, 24/7, 18/1, 397.5 30/7	556.5 26/7, 24/7, 18/1, 477.0, 500.0 30/7	636.0 54/7, 36/1, 26/7, 24/7, 18/1, 605.0 54/7, 30/19, 30/7, 26/7, 24/7, 556.5 30/7, 653.9 18/3	715.5 54/7, 45/7, 26/7, 24/7, 666.6 54/7, 26/7, 24/7, 636.0 30/19, 30/7	795.0 54/7, 45/7, 36/1, 26/7, 24/7, 715.5 30/7, 30/19	954.0 45/7, 36/1, 874.5, 900.0 54/7, 45/7, 795.0 54/7, 30/19, 30/7, 26/7, 24/7
	AAAC 6201-5003	503.6, 559.5, 599.6	587.2, 652.4, 652.8	704.6	740.8, 746.1	833.6	927.2, 932.6
	AAC Standard Round	477.0, 500.0 550.0, 556.5	600.0	636.0, 650.0, 700.0	715.5, 750.0	795.0, 800.0, 874.5	900.0, 954.0, 1000.0
	COPPER Standard Round	500.0, 550.0	600.0	650.0, 700.0	750.0	800.0, 850.0	900.0, 1000.0
	AAC Compressed or Compacted	556.5, 636.0	–	795.0	874.5	954.0	–
	ACSR Compressed or Compacted	556.518/1	636.0 18/1	795 36/1	874.5 36/1	954.0 36/1	–
	AWAC, ACAR	503.6 15/4, 12/7	568.3 15/4	653.1 15/4, 12/7	739.8 33/4, 30/7, 24/13, 18/19	862.7 18/19, 853.7 30/7, 24/13, 18/19, 840.2 24/13, 819.2 30/7	927.2, 1024.5 30/7, 24/13, 18/19, 1012.2 24/13, 983.1 30/7
	ALUMOWELD COPPERWELD	19 No. 6, 37 No. 9	37 No. 8	19 No. 5	37 No. 7	–	37 No. 6
	Galvanized Steel	–	7/8"	–	1"	–	–
	Solid: AL or CU	–	–	–	–	–	–

Use TAP Number **602180-6*** **602180-5*** **602180-4*** **602180-3*** **602180-2*** **602180-1***

*UL Listed

S T R A N S M I T T E R	Large Wire Groove Code							
	ACSR Standard Round		1033.5 54/7, 45/7, 36/1, 954.0 54/7, 30/7	1113.0 45/7, 54/19, 1192.5 36/1, 45/7	1113.0 45/7, 54/19, 1192.5 36/1, 45/7	1113.0 45/7, 54/19, 1192.5 36/1, 45/7	1113.0 45/7, 54/19, 1192.5 36/1, 45/7	1113.0 45/7, 54/19, 1192.5 36/1, 45/7
	AAAC 6201-5003		–	–	–	–	–	–
	AAC Standard Round		1033.5, 1110.0, 1113.0	1192.5, 1200.0, 1250.0, 1272.0	1192.5, 1200.0, 1250.0, 1272.0	1192.5, 1200.0, 1250.0, 1272.0	1192.5, 1200.0, 1250.0, 1272.0	1192.5, 1200.0, 1250.0, 1272.0
	COPPER Standard Round		–	–	–	–	–	–
	AAC Compressed or Compacted		–	–	–	–	–	–
	ACSR Compressed or Compacted		–	–	–	–	–	–
	AWAC, ACAR		1172.0 30/7, 24/13, 18/19, 33/4, 1081.0, 1109.0 30/7, 24/13, 18/19	–	–	–	–	–
	ALUMOWELD COPPERWELD		–	–	–	–	–	–
	Galvanized Steel		–	–	–	–	–	–
Solid: AL or CU		–	–	–	–	–	–	













ACSR Standard Round		1033.5 54/7, 45/7, 36/1, 954.0 54/7, 45/7, 30/7	6 6/1	5 6/1, 4 6/1, 7/1	3 6/1, 2 6/1, 7/1	1/0 6/1, 1 6/1, 80.0 8/1	2/0 6/1
AAAC 6201-5003		–	6	5, 4	3, 2	1/0, 1	2/0
AAC Standard Round		1033.5, 1110.0, 1113.0	6	5, 4, 3	2, 1	1/0	2/0
COPPER Standard Round		–	6	5, 4, 3	2	1/0, 1	2/0
AAC Compressed or Compacted		–	6	4, 3	2, 1	1/0, 2/0	3/0
ACSR Compressed or Compacted		–	6 6/1	4 6/1, 7/1	2 6/1, 7/1, 1 6/1	1/0 6/1	2/0 6/1
AWAC, ACAR		1172.0 33/4, 30/7, 24/13, 18/19, 1081.0, 1109.0 30/7, 24/13, 18/19	–	4 6/1, 5/2	4 4/3, 3/4, 3 6/1, 5/2, 4/3, 2 6/1, 5/2	4 2/5, 3 3/4, 2/5, 2 4/3, 3/4, 1 6/1, 5/2, 4/3, 1/0 6/1	2 2/5, 1 3/4, 1/0 5/2, 4/3, 2/0 6/1
ALUMOWELD COPPERWELD		–	8A, 8C, 3 No. 12	5A, 6A, 6C, 7A, 7D, 8D, 3 No. 9, 3 No. 10, 7 No. 12	2F, 2G, 3A, 4A, 4N, 3 No. 7, 3 No. 8, 7 No. 10, 7 No. 11	4D, 4P, 2A, 2J, 2K, 1F, 1G, 1/OF, 3 No. 5, 3 No. 6, 7 No. 8, 7 No. 9	1J, 1K, 2N, 1/OG, 1/OJ, 2/OF, 7 No. 7
Galvanized Steel		–	5/16"	7/32", 1/4"	9/32", 5/16"	11/32", 3/8"	7/16"
Solid: AL or CU		–	5, 6	2, 3, 4	1/0, 1	2/0	2/0, 3/0











Use TAP Number 602180* 1-602300-7 1-602300-6 1-602300-5 1-602300-4 1-602300-3

*UL Listed



Large Wire Groove Code						
S T R A N D E D	ACSR Standard Round 	1113.0 45/7, 54/19, 1192.5 36/1, 45/7	1113.0 45/7, 54/19, 1192.5 36/1, 45/7	1113.0 45/7, 54/19, 1192.5 36/1, 45/7	1113.0 45/7, 54/19, 1192.5 36/1, 45/7	1113.0 45/7, 54/19, 1192.5 36/1, 45/7
	AAAC 6201-5003 	–	–	–	–	–
	AAC Standard Round 	1192.5, 1200.0, 1250.0, 1272.0	1192.5, 1200.0, 1250.0, 1272.0	1192.5, 1200.0, 1250.0, 1272.0	1192.5, 1200.0, 1250.0, 1272.0	1192.5, 1200.0, 1250.0, 1272.0
	COPPER Standard Round 	–	–	–	–	–
	AAC Compressed or Compacted 	–	–	–	–	–
	ACSR Compressed or Compacted 	–	–	–	–	–
	AWAC, ACAR 	–	–	–	–	–
	ALUMOWELD COPPERWELD 	–	–	–	–	–
	Galvanized Steel 	–	–	–	–	–
	Solid: AL or CU 	–	–	–	–	–



S T R A N D E D	ACSR Standard Round 	3/0 6/1, 101.8, 110.8	4/0 6/1, 134.6, 159.0 12/7	176.9, 190.8 12/7, 266.8 18/1, 24/7, 6/7, 26/7, 30/7, 300.0 18/1	203.2 16/19, 211.3 12/7, 266.8 30/7, 300.0 24/7, 26/7, 30/7, 336.4 18/1, 24/7, 26/7	336.4 30/7, 397.5 18/1, 24/7, 26/7
	AAAC 6201-5003 	3/0	4/0	281.4, 312.8, 307.1	355.1, 394.5	419.6, 465.4
	AAC Standard Round 	3/0	4/0, 250.0	266.8, 300.0	336.4, 350.0, 397.5, 450.0, 477.0, 500.0	400.0, 450.0
	COPPER Standard Round 	3/0	4/0, 250.0	300.0	350.0	400.0, 450.0
	AAC Compressed or Compacted 	4/0	250.0, 266.8	336.4, 350.0	397.5, 477.0	500.0, 556.5
	ACSR Compressed or Compacted 	3/0 6/1	4/0, 266.8 6/1	336.4 18/1	397.5 18/1	477.0 18/1
	AWAC, ACAR 	1 2/5, 1/0 3/4, 2/5, 2/0 5/2, 4/3, 3/0 6/1	1/0 2/5, 2/0 3/4, 3/0 4/3, 5/2, 4/0 6/1, 15/4	–	336.4 18/1, 16/3, 15/4, 355.0 15/4, 12/7, 343.6 15/4	–
	ALUMOWELD COPPERWELD 	1N, 1/OK, 2/OJ, 2/OG, 3/OF, 7 No. 6	2/OK, 4/OEK, 4/OF, 4/OG, 7 No. 5, 19 No. 9, 19 No. 10	4/OE, 4/OG, 19 No. 8, 7 No. 4	19 No. 7, 37 No. 10	–
	Galvanized Steel 	1/2"	9/16"	5/8"	–	3/4"
	Solid: AL or CU 	4/0, 250.0	266.8, 300.0	350.0, 397.5, 400.0	–	–

Use TAP Number **1-602300-2** **1-602300-1** **1-602300-0** **602300-9** **602300-8**

*UL Listed



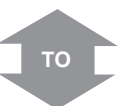
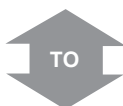
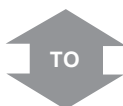
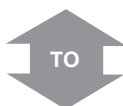
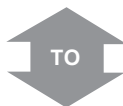







Large Wire Groove Code						
S T R A N S M I T T E R	ACSR Standard Round	1113.0 45/7, 54/19, 1192.5 36/1, 45/7	1113.0 45/7, 54/19, 1192.5 36/1, 45/7	1113.0 45/7, 54/19, 1192.5 36/1, 45/7	1113.0 45/7, 54/19, 1192.5 36/1, 45/7	1113.0 45/7, 54/19, 1192.5 36/1, 45/7
	AAAC 6201-5003	–	–	–	–	–
	AAC Standard Round	1192.5, 1200.0, 1250.0, 1272.0	1192.5, 1200.0, 1250.0, 1272.0	1192.5, 1200.0, 1250.0, 1272.0	1192.5, 1200.0, 1250.0, 1272.0	1192.5, 1200.0, 1250.0, 1272.0
	COPPER Standard Round	–	–	–	–	–
	AAC Compressed or Compacted	–	–	–	–	–
	ACSR Compressed or Compacted	–	–	–	–	–
	AWAC, ACAR	–	–	–	–	–
	ALUMOWELD COPPERWELD	–	–	–	–	–
	Galvanized Steel	–	–	–	–	–
	Solid: AL or CU	–	–	–	–	–











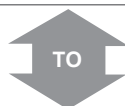
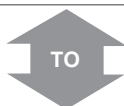
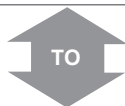

S T R A N S M I T T E R	ACSR Standard Round	397.5 30/7, 477.0 18/1, 24/7, 26/7	477.0, 500.0 30/7, 556.5 18/1, 24/7, 26/7	556.6 30/7, 605.0 24/7, 54/7, 26/7, 30/7, 30/19, 636.0 36/1, 18/1, 24/7, 26/7, 54/7, 653.9 18/3	636.0 30/7, 30/19, 666.6 24/7, 54/7, 26/7, 715.5 24/7, 54/7, 45/7, 26/7, 795.0 36/1	715.5 30/7, 30/19, 795.0 45/7, 24/7, 54/7, 26/7, 874.5 45/7
	AAAC 6201-5003	503.6, 559.5	587.2, 652.4	704.6, 740.8, 746.1	833.6	927.2, 932.6
	AAC Standard Round	477.0, 500.0, 550.0, 556.6	600.0, 636.0, 650.0	700.0, 715.5	750.0, 795.0, 800.0	874.5, 900.0, 954.0
	COPPER Standard Round	500.0, 550.0	600.0, 650.0	700.0	750.0, 800.0	850.0, 900.0
	AAC Compressed or Compacted	636.0	–	795.0, 874.5	954.0	–
	ACSR Compressed or Compacted	556.5, 636.0 18/1	–	795.0, 874.5 36/1	954.0 36/1	–
	AWAC, ACAR	503.6 15/4, 12/7	568.3 15/4, 653.1 15/4, 12/7	739.83 3/4, 30/7, 24/13, 18/19	819.2 30/7	840.2 24/13, 862.7 18/19, 853.7, 927.2 30/7, 24/13, 18/19
	ALUMOWELD COPPERWELD	19 No. 6, 37 No. 9	19 No. 5, 37 No. 8	–	37 No. 7	–
	Galvanized Steel	–	7/8"	–	1"	–
	Solid: AL or CU	–	–	–	–	–

Use TAP Number **602300-7** **602300-6** **602300-5** **602300-4** **602300-3**

*UL Listed

Large Wire Groove Code					
S T R A N D E D	ACSR Standard Round		1113.0 45/7, 54/19, 1192.5 36/1, 45/7	1113.0 45/7, 54/19, 1192.5 36/1, 45/7	1113.0 45/7, 54/19, 1192.5 36/1, 45/7
	AAAC 6201-5003		–	–	–
	AAC Standard Round		1192.5, 1200.0, 1250.0, 1272.0	1192.5, 1200.0, 1250.0, 1272.0	1192.5, 1200.0, 1250.0, 1272.0
	COPPER Standard Round		–	–	–
	AAC Compressed or Compacted		–	–	–
	ACSR Compressed or Compacted		–	–	–
	AWAC, ACAR		–	–	–
	ALUMOWELD COPPERWELD		–	–	–
	Galvanized Steel		–	–	–
	Solid: AL or CU		–	–	–



S T R A N D E D	ACSR Standard Round		795.0 30/7, 30/19, 874.5 54/7, 900.0 45/7, 54/7, 954.0 36/1, 45/7, 48/7	900.0 30/7, 954.0 54/7, 30/7, 1033.5 36/1, 45/7, 48/7, 54/7	1113.0 45/7, 54/19, 1192.5 36/1, 45/7
	AAAC 6201-5003		–	–	–
	AAC Standard Round		1000.0, 1033.5	1100.0, 1113.0	1192.5, 1200.0, 1250.0, 1272.0
	COPPER Standard Round		1000.0	–	–
	AAC Compressed or Compacted		–	–	–
	ACSR Compressed or Compacted		–	–	–
	AWAC, ACAR		983.1 30/7, 1012.2 24/13, 1024.5 24/13, 30/7, 18/19	1081.0, 1109.0 30/7, 24/13, 30/7, 1172.0 33/4, 30/7, 24/13, 18/19	–
	ALUMOWELD COPPERWELD		37 No. 6	–	–
	Galvanized Steel		–	–	–
	Solid: AL or CU		–	–	–

Use TAP Number

602300-2

602300-1

602300

*UL Listed

Wire ID Code	-	-	-	-	-	-	-
Copper Std. Round	8	6	6	4	1/0	1/0	4
Copper Compressed	-	-	-	-	-	-	-
Copper Compacted	-	-	-	-	-	-	-
Copper Solid	8, 6	4	4	2	-	-	2
COPPERWELD	-	-	-	-	-	-	-
Ground Rod	-	-	-	-	-	-	-
Pin Diameter	-	-	-	-	-	-	-



Copper Std. Round	8	8	6	8, 6	8, 6	4, 2	4
Copper Compressed	-	-	-	-	-	-	-
Copper Compacted	-	4	-	-	-	-	-
Copper Solid	8, 6	8	6, 4	8, 6	8, 6, 4	2	4, 2
COPPERWELD	-	-	-	-	-	-	-
Ground Rod	-	-	-	-	-	-	-
Pin Diameter	-	-	-	-	-	-	-

Use TAP Number **2182410-5** **2182410-5** **2182410-4** **2182410-4** **2182410-2** **21028410-2** **2102410-3**

Wire ID Code	00	NX	NW	NT	NO	NN	MX
Copper Std. Round	1/0	2/0	2/0	2/0	2/0	2/0	3/0
Copper Compressed	1/0	2/0	2/0	2/0	2/0	2/0	3/0
Copper Compacted	2/0	3/0	3/0	3/0	3/0	3/0	4/0
Copper Solid	2/0	3/0	3/0	3/0	3/0	3/0	4/0
COPPERWELD	7 No. 8, 1G, 3 No. 5, 2K, 1/0F, 2A, 1J, 4P	7 No. 7, 1/0G, 2/0F, 1K, 1/0J, 2N	7 No. 7, 1/0G, 2/0F, 1K, 1/0J, 2N	7 No. 7, 1/0G, 2/0F, 1K, 1/0J, 2N	7 No. 7, 1/0G, 2/0F, 1K, 1/0J, 2N	7 No. 7, 1/0G, 2/0F, 1K, 1/0J, 2N	7 No. 6, 1N, 2/0J, 2P, 2/0G, 1/0K
Ground Rod	3/8"	-	-	-	-	-	1/2"
Pin Diameter	3/8"	-	-	-	-	-	1/2"



Copper Std. Round	1/0	5, 6	4, 3	2, 1	1/0	2/0	5, 6
Copper Compressed	1/0	-	4	2, 1	1/0	2/0	-
Copper Compacted	2/0	4	2	1, 1/0	2/0	3/0	4
Copper Solid	2/0	4	3, 2	1, 1/0	2/0	3/0	4
COPPERWELD	7 No. 8, 1G, 3 No. 5, 2K, 1/0F, 2A, 1J, 4P	8A	3 No. 10, 6C, 3 No. 9, 6A, 3 No. 8, 8D, 6D	7 No. 10, 1F, 4N, 7 No. 9, 2J, 4D, 3 No. 7, 2G, 4A, 3 No. 6, 2F	7 No. 8, 1G, 3 No. 5, 2K, 1/0F, 2A, 1J, 4P	7 No. 7, 1/0G, 2/0F, 1K, 1/0J, 2N	8A
Ground Rod	3/8"	-	-	-	3/8"	-	-
Pin Diameter	3/8"	-	-	-	3/8"	-	-

Use TAP Number **1-275187-8*** **4-275187-0*** **3-275187-9** **1-275187-7*** **1-275187-6*** **1-275187-5*** **3-275187-7***

*UL Listed

Wire ID Code	-	-	-
Copper Std. Round	2	2	2
Copper Compressed	-	-	-
Copper Compacted	-	-	-
Copper Solid	2, 1/0	1/0	-
COPPERWELD	-	-	-
Ground Rod	-	-	-
Pin Diameter	-	-	-



Copper Std. Round	8, 6	4	2
Copper Compressed	-	-	-
Copper Compacted	-	-	-
Copper Solid	-	4, 2	1/0
COPPERWELD	-	-	-
Ground Rod	-	-	-
Pin Diameter	-	-	-

Use TAP Number **277060-8**** **277060-9**** **277060-10****

Wire ID Code	MW	MT	MO	MN	MM	LX	LW
Copper Std. Round	3/0	3/0	3/0	3/0	3/0	4/0	4/0
Copper Compressed	3/0	3/0	3/0	3/0	3/0	4/0, 250.0	4/0, 250.0
Copper Compacted	4/0	4/0	4/0	4/0	4/0	250.0	250.0
Copper Solid	4/0	4/0	4/0	4/0	4/0	-	-
COPPERWELD	7 No. 6, 1N, 2/OJ, 2P, 2/OG, 1/OKN	7 No. 6, 1N, 2/OJ, 2P, 2/OG, 1/OKN	7 No. 6, 1N, 2/OJ, 2P, 2/OG, 1/OK	7 No. 6, 1N, 2/OJ, 2P, 2/OG, 1/OK	7 No. 6, 1N, 2/OJ, 2P, 2/OG, 1/OK	7 No. 5, 4/OF, 2/OK	7 No. 5, 4/OF, 2/OK
Ground Rod	1/2"	1/2"	1/2"	1/2"	1/2"	-	-
Pin Diameter	1/2"	1/2"	1/2"	1/2"	1/2"	-	-

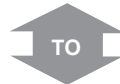

Copper Std. Round	4, 3	2, 1	1/0	2/0	3/0	5, 6	4, 3
Copper Compressed	4	2, 1	1/0	2/0	3/0	-	4
Copper Compacted	2	1, 1/0	2/0	3/0	4/0	4	2
Copper Solid	3, 2	1, 1/0	2/0	3/0	4/0	4	3, 2
COPPERWELD	3 No. 10, 6C, 3 No. 9, 6A, 3 No. 8, 8D, 6D	7 No. 10, 1F, 4N, 7 No. 9, 2J, 4D, 3 No. 7, 2G, 4A, 3 No. 6, 2F	7 No. 8, 1G, 3 No. 5, 2K, 1/OF, 2A, 1J, 4P	7 No. 7, 1/OG, 2/OF, 1K, 1/OJ, 2N	7 No. 6, 1N, 2/OJ, 2P, 2/OG, 1/OK	8A	3 No. 10, 6C, 3 No. 9, 6A, 3 No. 8, 8D, 6D
Ground Rod	-	-	3/8"	-	1/2"	-	-
Pin Diameter	-	-	3/8"	-	1/2"	-	-

Use TAP Number **3-275187-6*** **1-275187-4*** **1-275187-3*** **1-275187-2*** **1-275187-1*** **3-275187-4*** **3-275187-3***

*UL Listed

Wire ID Code	LT	LO	LN	LM	LL	RX	RW
Copper Std. Round	4/0	4/0	4/0	4/0	4/0	250.0	250.0
Copper Compressed	4/0, 250.0	4/0, 250.0	4/0, 250.0	4/0, 250.0	4/0, 250.0	300.0	300.0
Copper Compacted	250.0	250.0	250.0	250.0	250.0	300.0, 350.0	300.0, 350.0
Copper Solid	-	-	-	-	-	-	-
COPPERWELD	7 No. 5, 4/OF, 2/OK	7 No. 5, 4/OF, 2/OK	7 No. 5, 4/OF, 2/OK	7 No. 5, 4/OF, 2/OK	7 No. 5, 4/OF, 2/OK	19 No. 9, 4/OEK, 7 No. 4, 4/OE, 250EK, 4/OG	19 No. 9, 4/OEK, 7 No. 4, 4/OE, 250EK, 4/OG
Ground Rod	-	-	-	-	-	5/8"	5/8"
Pin Diameter	-	-	-	-	-	9/16"	9/16"

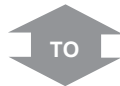

Copper Std. Round	4, 3	2, 1	1/0	2/0	3/0	5, 6	4, 3
Copper Compressed	4	2, 1	1/0	2/0	3/0	-	4
Copper Compacted	2	1, 1/0	2/0	3/0	4/0	4	2
Copper Solid	3, 2	1, 1/0	2/0	3/0	4/0	4	3, 2
COPPERWELD	3 No. 10, 6C, 3 No. 9, 6A, 3 No. 8, 8D, 6D	7 No. 10, 1F, 4N, 7 No. 9, 2J, 4D, 3 No. 7, 2G, 4A, 3 No. 6, 2F	7 No. 8, 1G, 3 No. 5, 2K, 1/OF, 2A, 1J, 4P	7 No. 7, 1/OG, 2/OF, 1K, 1/OJ, 2N	7 No. 6, 1N, 2/OJ, 2P, 2/OG, 1/OK	8A	3 No. 10, 6C, 3 No. 9, 6A, 3 No. 8, 8D, 6D
Ground Rod	-	-	3/8"	-	1/2"	-	-
Pin Diameter	-	-	3/8"	-	1/2"	-	-

Use TAP Number **1-275187-0*** **275187-9*** **275187-8*** **275187-7*** **275187-6*** **3-275187-1*** **3-275187-0***

Wire ID Code	RT	RO	RN	RM	RL	RR
Copper Std. Round	250.0	250.0	250.0	250.0	250.0	250.0
Copper Compressed	300.0	300.0	300.0	300.0	300.0	300.0
Copper Compacted	300.0, 350.0	300.0, 350.0	300.0, 350.0	300.0, 350.0	300.0, 350.0	300.0, 350.0
Copper Solid	-	-	-	-	-	-
COPPERWELD	19 No. 9, 4/OEK, 7 No. 4, 4/OE, 250EK, 4/OG	19 No. 9, 4/OEK, 7 No. 4, 4/OE, 250EK, 4/OG	19 No. 9, 4/OEK, 7 No. 4, 4/OE, 250EK, 4/OG	19 No. 9, 4/OEK, 7 No. 4, 4/OE, 250EK, 4/OG	19 No. 9, 4/OEK, 7 No. 4, 4/OE, 250EK, 4/OG	19 No. 9, 4/OEK, 7 No. 4, 4/OE, 250EK, 4/OG
Ground Rod	5/8"	5/8"	5/8"	5/8"	5/8"	5/8"
Pin Diameter	9/16"	9/16"	9/16"	9/16"	9/16"	9/16"



Copper Std. Round	2, 1	1/0	2/0	3/0	4/0	250.0
Copper Compressed	2, 1	1/0	2/0	3/0	4/0, 250.0	300.0
Copper Compacted	1, 1/0	2/0	3/0	4/0	250.0	300.0, 350.0
Copper Solid	1, 1/0	2/0	3/0	4/0	-	-
COPPERWELD	7 No. 10, 1F, 4N, 7 No. 9, 2J, 4D, 3 No. 7, 2G, 4A, 3 No. 6, 2F	7 No. 8, 1G, 3 No. 5, 2K, 1/OF, 2A, 1J, 4P	7 No. 7, 1/OG, 2/OF, 1K, 1/OJ, 2N	7 No. 6, 1N, 2/OJ, 2P, 2/OG, 1/OK	7 No. 5, 4/OF, 2/OK	19 No. 9, 4/OEK, 7 No. 4, 4/OE, 250EK, 4/OG
Ground Rod	-	3/8"	-	1/2"	-	5/8"
Pin Diameter	-	3/8"	-	1/2"	-	9/16"

Use TAP Number **275187-5*** **275187-4*** **275187-3*** **275187-2*** **275187-1*** **2-275187-8***

Wire ID Code	HX	HW	HT	HO	HN	HM	HL
Copper Std. Round	300.0	300.0	300.0	300.0	300.0	300.0	300.0
Copper Compressed	-	-	-	-	-	-	-
Copper Compacted	-	-	-	-	-	-	-
Copper Solid	-	-	-	-	-	-	-
COPPERWELD	19 No. 8, 250EK	19 No. 8, 250EK	19 No. 8, 250EK	19 No. 8, 250EK	19 No. 8, 250EK	19 No. 8, 250EK	19 No. 8, 250EK
Ground Rod	-	-	-	-	-	-	-
Pin Diameter	5/8"	5/8"	5/8"	5/8"	5/8"	5/8"	5/8"

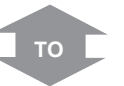
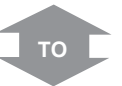

Copper Std. Round	5, 6	4, 3	2, 1	1/0	2/0	3/0	4/0
Copper Compressed	-	4	2, 1	1/0	2/0	3/0	4/0, 250.0
Copper Compacted	4	2	1, 1/0	2/0	3/0	4/0	250.0
Copper Solid	4	3, 2	1, 1/0	2/0	3/0	4/0	-
COPPERWELD	8A	3 No. 10, 6C, 3 No. 9, 6A, 3 No. 8, 8D, 6D	7 No. 10, 1F, 4N, 7 No. 9, 2J, 4D, 3 No. 7, 2G, 4A, 3 No. 6 2F	7 No. 8, 1G, 3 No. 5, 2K, 1/0F, 2A, 1J, 4P	7 No. 7, 1/0G, 2/0F, 1K, 1/0J, 2N	7 No. 6, 1N, 2/0J, 2P, 2/0G, 1/0K	7 No. 5, 4/0F, 2/0K
Ground Rod	-	-	-	3/8"	-	1/2"	-
Pin Diameter	-	-	-	3/8"	-	1/2"	-

Use TAP Number 6-276337-5* 6-276337-4* 6-276337-2* 6-276337-0* 5-276337-9* 5-276337-8* 5-276337-7*

Wire ID Code	HK	HH	GX	GW	GT	GO	GN
Copper Std. Round	300.0	300.0	350.0	350.0	350.0	350.0	350.0
Copper Compressed	-	-	350.0	350.0	350.0	350.0	350.0
Copper Compacted	-	-	400.0	400.0	400.0	400.0	400.0
Copper Solid	-	-	-	-	-	-	-
COPPERWELD	19 No. 8, 250EK	19 No. 8, 250EK	300EK, 250EK	300EK, 250EK	300EK, 250EK	300EK, 250EK	300EK, 250EK
Ground Rod	-	-	3/4"	3/4"	3/4"	3/4"	3/4"
Pin Diameter	5/8"	5/8"	-	-	-	-	-

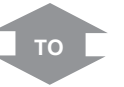
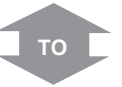

Copper Std. Round	250.0	300.0	5, 6	4, 3	2, 1	1/0	2/0
Copper Compressed	300.0	-	-	4	2, 1	1/0	2/0
Copper Compacted	300.0, 350.0	-	4	2	1, 1/0	2/0	3/0
Copper Solid	-	-	4	3, 2	1, 1/0	2/0	3/0
COPPERWELD	19 No. 9, 4/0EK, 7 No. 4, 4/0E, 250EK, 4/0G	19 No. 8, 250EK	8A	3 No. 10, 6C, 3 No. 9, 6A, 3 No. 8, 8D, 6D	7 No. 10, 1F, 4N, 7 No. 9, 2J, 4D, 3 No. 7, 2G, 4A, 3 No. 6, 2F	7 No. 8, 1G, 3 No. 5, 2K, 1/0F, 2A, 1J, 4P	7 No. 7, 1/0G, 2/0F, 1K, 1/0J, 2N
Ground Rod	5/8"	-	-	-	-	3/8"	-
Pin Diameter	9/16"	5/8"	-	-	-	3/8"	-

Use TAP Number 5-276337-6* 5-276337-5* 5-276337-4* 5-276337-3* 5-276337-1* 4-276337-9* 4-276337-8*

Wire ID Code	GM	GL	GK	GH	GG	EX	EW
Copper Std. Round	350.0	350.0	350.0	350.0	350.0	400.0	400.0
Copper Compressed	350.0	350.0	350.0	350.0	350.0	400.0	400.0
Copper Compacted	400.0	400.0	400.0	400.0	400.0	450.0, 500.0	450.0, 500.0
Copper Solid	-	-	-	-	-	-	-
COPPERWELD	300EK, 250EK	300EK, 250EK	300EK, 250EK	300EK, 250EK	300EK, 250EK	300E, 350EK, 19 No. 7, 37 No. 10	300E, 350EK, 19 No. 7, 37 No. 10
Ground Rod	3/4"	3/4"	3/4"	3/4"	3/4"	-	-
Pin Diameter	-	-	-	-	-	-	-

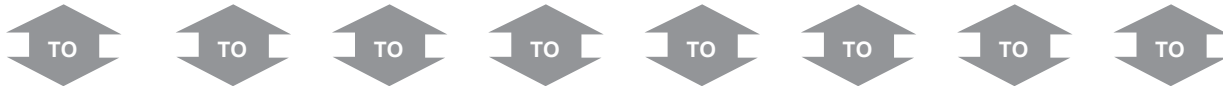

Copper Std. Round	3/0	4/0	250.0	300	350.0	5, 6	4, 3
Copper Compressed	3/0	4/0, 250.0	300.0	-	350.0	-	4
Copper Compacted	4/0	250.0	300.0, 350.0	-	400.0	4	2
Copper Solid	4/0	-	-	-	-	4	3, 2
COPPERWELD	7 No. 6, 1N, 2/OJ, 2P, 2/OG, 1/OK	7 No. 5, 4/OF, 2/OK	19 No. 9, 4/OEK, 7 No. 4, 4/OE, 250EK, 4/OG	19 No. 8, 250EK	300EK, 250EK	#8A	3 No. 10, 6C, 3 No. 9, 6A, 3 No. 8, 8D, 6D
Ground Rod	1/2"	-	5/8"	-	3/4"	-	-
Pin Diameter	1/2"	-	9/16"	5/8"	-	-	-

Use TAP Number 4-276337-7* 4-276337-6* 4-276337-5* 4-276337-4* 4-276337-3* 4-276337-2* 4-276337-1*

Wire ID Code	ET	EO	EN	EM	EL	EK	EH
Copper Std. Round	400.0	400.0	400.0	400.0	400.0	400.0	400.0
Copper Compressed	400.0	400.0	400.0	400.0	400.0	400.0	400.0
Copper Compacted	450.0, 500.0	450.0, 500.0	450.0, 500.0	450.0, 500.0	450.0, 500.0	450.0, 500.0	450.0, 500.0
Copper Solid	-	-	-	-	-	-	-
COPPERWELD	300E, 350EK, 19 No. 7, 37 No. 10	300E, 350EK, 19 No. 7, 37 No. 10	300E, 350EK, 19 No. 7, 37 No. 10	300E, 350EK, 19 No. 7, 37 No. 10	300E, 350EK, 19 No. 7, 37 No. 10	300E, 350EK, 19 No. 7, 37 No. 10	300E, 350EK, 19 No. 7, 37 No. 10
Ground Rod	-	-	-	-	-	-	-
Pin Diameter	-	-	-	-	-	-	-

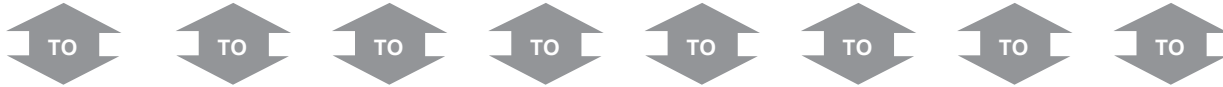

Copper Std. Round	2, 1	1/0	2/0	3/0	4/0	250.0	300.0
Copper Compressed	2, 1	1/0	2/0	3/0	4/0, 250.0	300.0	-
Copper Compacted	1, 1/0	2/0	3/0	4/0	250.0	300.0, 350.0	-
Copper Solid	1, 1/0	2/0	3/0	4/0	-	-	-
COPPERWELD	7 No. 10, 1F, 4N, 7 No. 9, 2J, 4D, 3 No. 7, 2G, 4A, 3 No. 6, 2F	7 No. 8, 1G, 3 No. 5, 2K, 1/OF, 2A, 1J, 4P	7 No. 7, 1/OG, 2/OF, 1K, 1/OJ, 2N	7 No. 6, 1N, 2/OJ, 2P, 2/OG, 1/OK	7 No. 5, 4/OF, 2/OK	19 No. 9, 4/OEK, 7 No. 4, 4/OE, 250EK, 4/OG	19 No. 8, 250EK
Ground Rod	-	3/8"	-	1/2"	-	5/8"	-
Pin Diameter	-	3/8"	-	1/2"	-	9/16"	5/8"

Use TAP Number 3-276337-9* 3-276337-7* 3-276337-6* 3-276337-5* 3-276337-4* 3-276337-3* 3-276337-2*

Wire ID Code	EG	EE	BX	BW	BT	BO	BN
Copper Std. Round	400.0	400.0	450.0	450.0	450.0	450.0	450.0
Copper Compressed	400.0	400.0	450.0	450.0	450.0	450.0	450.0
Copper Compacted	450.0, 500.0	450.0, 500.0	550.0	550.0	550.0	550.0	550.0
Copper Solid	-	-	-	-	-	-	-
COPPERWELD	300E, 350EK, 19 No. 7, 37 No. 10	300E, 350EK, 19 No. 7, 37 No. 10	-	-	-	-	-
Ground Rod	-	-	-	-	-	-	-
Pin Diameter	-	-	3/4"	3/4"	3/4"	3/4"	3/4"



Copper Std. Round	350.0	400.0	5, 6	4, 3	2, 1	1/0	2/0
Copper Compressed	350.0	400.0	-	4	2, 1	1/0	2/0
Copper Compacted	400.0	450.0, 500.0	4	2	1, 1/0	2/0	3/0
Copper Solid	-	-	4	3, 2	1, 1/0	2/0	3/0
COPPERWELD	300EK, 250EK	300E, 350EK, 19 No. 7, 37 No. 10	#8A	3 No. 10, 6C, 3 No. 9, 6A, 3 No. 8, 8D, #6D	7 No. 10, 1F, 4N, 7 No. 9, 2J, 4D, 3 No. 7, 2G, 4A, 3 No. 6, 2F	7 No. 8, 1G, 3 No. 5, 2K, 1/0F, 2A, 1J, 4P	7 No. 7, 1/0G, 2/0F, 1K, 1/0J, 2N
Ground Rod	3/4"	-	-	-	-	3/8"	-
Pin Diameter	-	-	-	-	-	3/8"	-

Use TAP Number **3-276337-1*** **3-276337-0*** **2-276337-9*** **2-276337-8*** **276337-4*** **2-276337-5*** **276337-3***

Wire ID Code	BM	BL	BK	BH	BG	BE	BB
Copper Std. Round	450.0	450.0	450.0	450.0	450.0	450.0	450.0
Copper Compressed	450.0	450.0	450.0	450.0	450.0	450.0	450.0
Copper Compacted	550.0	550.0	550.0	550.0	550.0	550.0	550.0
Copper Solid	-	-	-	-	-	-	-
COPPERWELD	-	-	-	-	-	-	-
Ground Rod	-	-	-	-	-	-	-
Pin Diameter	3/4"	3/4"	3/4"	3/4"	3/4"	3/4"	3/4"



Copper Std. Round	3/0	4/0	250.0	300	350.0	400.0	450.0
Copper Compressed	3/0	4/0, 250.0	300.0	-	350.0	400.0	450.0
Copper Compacted	4/0	250.0	300.0, 350.0	-	400.0	450.0, 500.0	550.0
Copper Solid	4/0	-	-	-	-	-	-
COPPERWELD	7 No. 6, 1N, 2/0J, 2P, 2/0G, 1/0K	7 No. 5, 4/0F, 2/0K	19 No. 9, 4/0EK, 7 No. 4, 4/0E, 250EK, 4/0G	19 No. 8, 250EK	300EK, 250EK	300E, 350EK, 19 No. 7, 37 No. 10	-
Ground Rod	1/2"	-	5/8"	-	3/4"	-	-
Pin Diameter	1/2"	-	9/16"	5/8"	-	-	3/4"

Use TAP Number **2-276337-4*** **276337-2*** **2-276337-3*** **2-276337-2*** **2-276337-1*** **2-276337-0*** **1-276337-9***

Wire ID Code	AX	AW	AT	AO	AN	AM	AL
Copper Std. Round	500.0	500.0	500.0	500.0	500.0	500.0	500.0
Copper Compressed	500.0	500.0	500.0	500.0	500.0	500.0	500.0
Copper Compacted	600.0	600.0	600.0	600.0	600.0	600.0	600.0
Copper Solid	-	-	-	-	-	-	-
COPPERWELD	350E, 19 No.6, 37 No. 9	350E, 19 No.6, 37 No. 9	350E, 19 No.6, 37 No. 9	350E, 19 No.6, 37 No. 9	350E, 19 No.6, 37 No. 9	350E, 19 No.6, 37 No. 9	350E, 19 No.6, 37 No. 9
Ground Rod	-	-	-	-	-	-	-
Pin Diameter	-	-	-	-	-	-	-



Copper Std. Round	5, 6	4, 3	2, 1	1/0	2/0	3/0	4/0
Copper Compressed	-	4	2, 1	1/0	2/0	3/0	4/0, 250.0
Copper Compacted	4	2	1, 1/0	2/0	3/0	4/0	250.0
Copper Solid	4	3, 2	1, 1/0	2/0	3/0	4/0	-
COPPERWELD	8A	3 No. 10, 6C, 3 No. 9, 6A, 3 No. 8, 8D, 6D	7 No. 10, 1F, 4N, 7 No. 9, 2J, 4D, 3 No. 7, 2G, 4A, 3 No. 6, 2F	7 No. 8, 1G, 3 No. 5, 2K, 1/OF, 2A, 1J, 4P	7 No. 7, 1/OG, 2/OF, 1K, 1/OJ, 2N	7 No. 6, 1N, 2/OJ, 2P, 2/OG, 1/OK	7 No. 5, 4/OF, 2/OK
Ground Rod	-	-	-	3/8"	-	1/2"	-
Pin Diameter	-	-	-	3/8"	-	1/2"	-











Use TAP Number 1-276337-8* 1-276337-7* 276337-8* 1-276337-4* 276337-7* 1-276337-3* 276337-6*

Wire ID Code	AK	AH	AG	AE	AB	AA
Copper Std. Round	500.0	500.0	500.0	500.0	500.0	500.0
Copper Compressed	500.0	500.0	500.0	500.0	500.0	500.0
Copper Compacted	600.0	600.0	600.0	600.0	600.0	600.0
Copper Solid	-	-	-	-	-	-
COPPERWELD	350E, 19 No.6, 37 No. 9	350E, 19 No.6, 37 No. 9	350E, 19 No.6, 37 No. 9	350E, 19 No.6, 37 No. 9	350E, 19 No.6, 37 No. 9	350E, 19 No.6, 37 No. 9
Ground Rod	-	-	-	-	-	-
Pin Diameter	-	-	-	-	-	-













Copper Std. Round	250.0	300.0	350.0	400.0	450.0	500.0
Copper Compressed	300.0	-	350.0	400.0	450.0	500.0
Copper Compacted	300.0, 350.0	-	400.0	450.0, 500.0	550.0	600.0
Copper Solid	-	-	-	-	-	-
COPPERWELD	19 No. 9, 4/OEK, 7 No. 4, 4/OE, 250EK, 4/OG	19 No. 8, 250EK	300EK, 250EK	300E, 350EK, 19 No. 7, 37 No. 10	-	350E, 19 No. 6, 37 No. 9
Ground Rod	5/8"	-	3/4"	-	-	-
Pin Diameter	9/16"	5/8"	-	-	3/4"	-











Use TAP Number 276337-9* 1-276337-2* 1-276337-1* 1-276337-0* 276337-1* 276337-5*











Stirrup Selection Thru Wire Stranded	Red Shell No. 69338-2 Small Wire Range		White Shell No. 69338-5 Type II Stirrups		
ACSR Standard Round 	6 6/1	2, 3, 4, 5, 6/1, 7/1	6 6/1	2, 3, 4, 5, 6/1, 7/1	1/0, 1, 2, 3, 6/1, 7/1
AAAC 6201 - 5003 	6	2, 3, 4, 5	6	2, 3, 4, 5	1/0, 1, 2, 3
AAC Standard Round 	6	2, 3, 4, 5	6	2, 3, 4, 5	1/0, 1, 2, 3
COPPER Standard Round 	6	2, 3, 4, 5	6	2, 3, 4, 5	2, 3
AAC Compressed or Compacted 	6	1, 2, 3, 4,	6	1, 2, 3, 4,	1/0, 1, 2
ACSR Compressed or Compacted 	6 6/1	2, 4, 6 6/1, 7/1	6 6/1	2, 4, 6 6/1, 7/1	1/0, 1, 2
AWAC, ACAR 	—	2 6/1, 3 4/3, 5/2, 6/1 4 3/4, 4/3, 5/2, 6/1	—	2 6/1, 3 4/3, 5/2, 6/1 4 3/4, 4/3, 5/2, 6/1	1/0 6/1, 2 6/1, 5/2, 4/3 3/4, 2/5, 1 6/1, 5/2, 4/3, 3 6/1, 5/2, 4/3, 3/4, 2/5
ALUMOWELD COPPERWELD 	8A, 8C, 3 No. 12	2F, 2G, 3A, 4A, 4N, 5A, 5D, 6A, 6C, 6D, 7A, 7D, 8D, 3 No. 7, 3 No. 10, 3 No. 8, 7 No. 10, 7 No. 12, 3 No. 9, 7 No. 11	8A, 8C, 3 No. 12	2F, 2G, 3A, 4A, 4N, 5A, 5D, 6A, 6C, 6D, 7A, 7D, 8D, 3 No. 7, 3 No. 10, 3 No. 8, 7 No. 10, 7 No. 12, 3 No. 9, 7 No. 11	45/2, 4/3, 3/4, 5/2, 1/0F, 1F, 1G, 1J, 2A, 2F, 2G, 2J, 2K, 3A, 4A, 4D, 4N, 4P, 5D, 6D, 3 No. 5, 3 No. 6, 3 No. 7, 3 No. 8, 7 No. 8, 7 No. 9, 7 No. 10, 7 No. 11
Galvanized Steel 	3/16"	1/4", 5/16", 7/32", 9/32"	3/16"	1/4", 5/16", 7/32", 9/32"	9/32, 5/16, 11/32, 3/8
Solid: AL or CU 	6, 5, 4	3, 2, 1	6, 5, 4	3, 2, 1	1
Stirrup Color & Number	Red 600580	Red 600581	White 602585	White 602586	White 81667-1
Bail Size	#2	#2	#2	#2	#2











Red coded taps are not sold in North America and should be substituted with white coded taps.











*UL Listed

Stirrup Selection Thru Wire Stranded	Blue Shell No. 69338-1 Medium Wire Range						
ACSR Standard Round		1, 1/0, 2/0 6/1, 80.0 8/1	80.0 8/1	2/0, 3/0 6/1, 101.8, 110.8, 134.6 12/1	3/0, 4/0 6/1, 101.8, 110.8, 134.6 12/1	3/0, 4/0 6/1, 101.8, 110.8, 134.6 12/7	3/0, 4/0 6/1, 101.8, 110.8, 134.6 12/7
AAAC 6201 - 5003		1, 1/0, 2/0	1, 1/0, 2/0	2/0, 3/0	3/0, 4/0	3/0, 4/0	3/0, 4/0
AAC Standard Round		1, 1/0, 2/0	1, 1/0, 2/0	2/0, 3/0	3/0, 4/0	4/0	4/0
COPPER Standard Round		1, 1/0, 2/0	1, 1/0, 2/0	2/0, 3/0	3/0, 4/0	4/0	4/0
AAC Compressed or Compacted		1/0, 2/0	1/0, 2/0	2/0, 3/0	3/0, 4/0, 250.0, 266.8	4/0, 250.0, 266.8	4/0, 250.0, 266.8
ACSR Compressed or Compacted		1, 1/0, 2/0 6/1	1, 1/0, 2/0 6/1	2/0, 3/0 6/1	3/0, 4/0 6/1 266.8 18/1	4/0 6/1 266.8 18/1	4/0 6/1 266.8 18/1
AWAC, ACAR		2/0, 1/0, 1 6/1, 1/0 4/3, 2, 1/0, 5/2, 2, 1 2/5, 3/4, 4/3, 3 2/5, 3/4, 4 2/5	2/0, 1/0, 1 6/1, 1/0 4/3, 2, 1/0, 5/2, 2, 1 2/5, 3/4, 4/3, 3 2/5, 3/4, 4 2/5	3/0 6/1, 2/0 4/3, 5/2, 6/1, 1/0 3/4, 4/3, 5/2, 1 2/5, 3/4	4/0 6/1, 3/0 4/3, 5/2, 6/1, 2/0 4/3, 3/4, 5/2, 1/0 3/4, 2/5, 1 2/5	4/0 6/1, 3/0 4/3, 5/2, 6/1, 2/0 4/3, 3/4, 5/2, 1/0 3/4, 2/5, 1 2/5	4/0 6/1, 3/0 4/3, 5/2, 6/1, 2/0 4/3, 3/4, 5/2, 1/0 3/4, 2/5, 1 2/5
ALUMOWELD COPPERWELD		1/0F, 1/0G, 1/0J, 2/0F, 1F, 1G, 1J, 1K, 2A, 2J, 2K, 2N, 4D, 4P, 3 No. 5, 3 No. 6, 7 No. 7, 7 No. 8, 7 No. 9	1/0F, 1/0G, 1/0J, 2/0F, 1F, 1G, 1J, 1K, 2A, 2J, 2K, 2N, 4D, 4P, 3 No. 5, 3 No. 6, 7 No. 7, 7 No. 8, 7 No. 9	1/0G, 1/0J, 1/0K, 2/0F, 2/0G, 2/0J, 1N, 2N, 2P, 7 No. 6, 7 No. 7	1/0K, 2/0G, 2/0J, 2/0K, 3/0F, 4/0F, 1N, 2P, 7 No. 5, 7 No. 6, 19 No. 10	1/0K, 2/0G, 2/0J, 2/0K, 3/0F, 4/0F, 1N, 2P, 7 No. 5, 7 No. 6, 19 No. 10	1/0K, 2/0G, 2/0J, 2/0K, 3/0F, 4/0F, 1N, 2P, 7 No. 5, 7 No. 6, 19 No. 10
Galvanized Steel		11/32", 3/8", 7/16"	11/32", 3/8", 7/16"	7/16", 1/12"	1/2", 9/16"	1/2", 9/16"	1/2", 9/16"
Solid: AL or CU		1/0, 2/0, 3/0	1/0, 2/0, 3/0	2/0, 3/0, 4/0	250.0, 266.8, 300.0, 3/0, 4/0	250.0, 266.8, 300.0, 4/0	250.0, 266.8, 300.0, 4/0
Stirrup Color & Number		Blue 600464	Blue 275436-1	Blue 600468	Blue 600469	Blue 275435-1	Blue 602173
Bail Size		#2	#1/0	#2	#2	#1/0	#2/0

Stirrup Selection Thru Wire Stranded	Blue Shell No. 69338-1 Medium Wire Range				
ACSR Standard Round		266.8 24/7, 26/7, 18/1, 6/7, 159.0, 176.9, 190.8	266.8 24/7, 26/7, 18/1, 6/7, 159.0, 176.9, 190.8	266.8 6/7, 18/1, 24/1, 26/7, 30/7, 300.0 18/1, 24/7, 26/7, 336.4 18/1	266.8 6/7, 18/1, 24/1, 26/7, 30/7, 300.0 18/1, 24/7, 26/7, 336.4 18/1
AAAC 6201 - 5003		281.4, 307.1, 312.8	281.4, 307.1, 312.8	281.4, 307.1, 312.8, 355.1	281.4, 307.1, 312.8, 355.1
AAC Standard Round		250.0, 266.8, 300.0	250.0, 266.8, 300.0	300.0, 336.4, 350.0	300.0, 336.4, 350.0
COPPER Standard Round		250.0, 300.0	250.0, 300.0	250.0, 300.0, 350.0	250.0, 300.0, 350.0
AAC Compressed or Compacted		266.8, 300.0, 336.4, 350.0	266.8, 300.0, 336.4, 350.0	336.4, 350.0, 397.5	336.4, 350.0, 397.5
ACSR Compressed or Compacted		266.8, 336.4 18/1	266.8, 336.4 18/1	336.4, 397.5 18/1	336.4, 397.5 18/1
AWAC, ACAR		4/0 15/4	4/0 15/4	336.4 18/1, 343.6 15/4, 355.0 15/4, 12/7	336.4 18/1, 343.6 15/4, 355.0 15/4, 12/7
ALUMOWELD COPPERWELD		4/0E, 4/0G, 7 No. 4, 19 No. 8, 19 No. 9	4/0E, 4/0G, 7 No. 4, 19 No. 8, 19 No. 9	4/0E, 7 No. 4, 19 No. 8	4/0E, 7 No. 4, 19 No. 8
Galvanized Steel		5/8"	5/8"	5/8"	5/8"
Solid: AL or CU		336.4, 350.0, 397.6, 400.0	336.4, 350.0, 397.6, 400.0	397.5, 400.0, 450.0	397.5, 400.0, 450.0
Stirrup Color & Number		Blue 600463	Blue 602201	Blue 602502	Blue 276478-1
Bail Size		#2	#1/0	#1/0	#2

Stirrup Selection Thru Wire Stranded	Yellow Shell No. 69338-4 Large Wire Range						
ACSR Standard Round		336.4 26/7, 24/7, 18/1, 266.8 30/7, 300.0 18/1, 24/7, 26/7, 30/7, 211.3 12/7, 203.2 16/19	336.4 26/7, 24/7, 18/1, 266.8 30/7, 300.0 18/1, 24/7, 26/7, 30/7, 211.3 12/7, 203.2 16/19	336.4 26/7, 24/7, 18/1, 266.8 30/7, 300.0 18/1, 24/7, 26/7, 30/7, 211.3 12/7, 203.2 16/19	477.0 26/7, 24/7, 18/1, 336.4 30/7, 397.5 30/7, 26/7, 24/7, 18/1	477.0 26/7, 24/7, 18/1, 336.4 30/7, 397.5 30/7, 26/7, 24/7, 18/1	477.0 26/7, 24/7, 18/1, 336.4 30/7, 397.5 30/7, 26/7, 24/7, 18/1
AAAC 6201 - 5003		355.1, 394.5, 394.6	355.1, 394.5, 394.6	355.1, 394.5, 394.6	419.6, 466.3, 465.4, 503.6	419.6, 466.3, 465.4, 503.6	419.6, 466.3, 465.4, 503.6
AAC Standard Round		336.4, 350.0, 397.5, 400.0	336.4, 350.0, 397.5, 400.0	336.4, 350.0, 397.5, 400.0	450.0, 477.0, 500.0, 550.0, 556.5	450.0, 477.0, 500.0, 550.0, 556.5	450.0, 477.0, 500.0, 550.0, 556.5
COPPER Standard Round		350.0, 400.0	350.0, 400.0	350.0, 400.0	450.0, 500.0, 550.0	450.0, 500.0, 550.0	450.0, 500.0, 550.0
AAC Compressed or Compacted		336.4, 350.0, 397.5	336.4, 350.0, 397.5	336.4, 350.0, 397.5	477.0, 500.0, 556.6, 636.0	477.0, 500.0, 556.6, 636.0	477.0, 500.0, 556.6, 636.0
ACSR Compressed or Compacted		336.4, 397.518/1	336.4, 397.518/1	336.4, 397.518/1	477.0, 556.6, 636.018/1	477.0, 556.6, 636.018/1	477.0, 556.6, 636.018/1
AWAC, ACAR		343.6 15/4, 355.01 5/4, 12/7, 336.4 18/1, 16/3, 15/4	343.6 15/4, 355.01 5/4, 12/7, 336.4 18/1, 16/3, 15/4	343.6 15/4, 355.01 5/4, 12/7, 336.4 18/1, 16/3, 15/4	503.6 15/4, 12/7, 336.4 15/4	503.6 15/4, 12/7, 336.4 15/4	503.6 15/4, 12/7, 336.4 15/4
ALUMOWELD COPPERWELD		4/OE, 7 No. 4, 19 No. 7, 19 No. 8, 37 No. 10	4/OE, 7 No. 4, 19 No. 7, 19 No. 8, 37 No. 10	4/OE, 7 No. 4, 19 No. 7, 19 No. 8, 37 No. 10	19 No. 6, 37 No. 8	19 No. 6, 37 No. 9	19 No. 6, 37 No. 9
Galvanized Steel		5/8"	5/8"	5/8"	3/4"	3/4"	3/4"
Solid: AL or CU		450.0, 477.0, 500.0	450.0, 477.0, 500.0	450.0, 477.0, 500.0	-	-	-
Stirrup Color & Number		Yellow 600474	Yellow 602142	Yellow 602136	Yellow 602047	Yellow 602143	Yellow 602247
Bail Size		1/0	2/0	4/0	1/0	2/0	4/0

Stirrup Selection Thru Wire Stranded	Yellow Shell No. 69338-4 Large Wire Range					
ACSR Standard Round		556.5 26/7, 24/7, 18/1, 477.0 30/7, 26/7, 24/7	556.5 26/7, 24/7, 18/1, 477.0 30/7, 26/7, 24/7	556.5 26/7, 24/7, 18/1, 477.0 30/7, 26/7, 24/7	556.5 30/7, 605.0, 636.0 54/7, 24/7, 26/7, 30/19, 30/7, 636.0 18/1, 36/1, 653.9 18/3 666.6 24/7, 54/7, 26/7	556.5 30/7, 605.0, 636.0 54/7, 24/7, 26/7, 30/19, 30/7, 636.0 18/1, 36/1, 653.9 18/3 666.6 24/7, 54/7, 26/7
AAAC 6201 - 5003		559.5, 587.2, 599.6, 652.4, 652.8	559.5, 587.2, 599.6, 652.4, 652.8	559.5, 587.2, 599.6, 652.4, 652.8	704.6, 740.8, 746.1	704.6, 740.8, 746.1
AAC Standard Round		550.0, 556.5, 600.0, 636.5	550.0, 556.5, 600.0, 636.5	550.0, 556.5, 600.0, 636.5	650.0, 700.0, 715.5, 750.0	650.0, 700.0, 715.5, 750.0
COPPER Standard Round		550.0, 600.0	550.0, 600.0	550.0, 600.0	650.0, 700.0, 750.0	650.0, 700.0, 750.0
AAC Compressed or Compacted		-	-	-	795.0, 874.5	795.0, 874.5
ACSR Compressed or Compacted		636.0 18/1	636.0 18/1	636.0 18/1	795.0, 874.5 36/1	795.0, 874.5 36/1
AWAC, ACAR		653.1 15/4, 12/7 568.3 15/4	653.1 15/4, 12/7 568.3 15/4	653.1 15/4, 12/7 568.3 15/4	739.8 33/4, 30/7, 24/13, 18/19	739.8 33/4, 30/7, 24/13, 18/19
ALUMOWELD COPPERWELD		19 No. 5, 37 No. 8	19 No. 5, 37 No. 8	19 No. 5, 37 No. 8	37 No. 7	37 No. 7
Galvanized Steel		7/8"	7/8"	7/8"	1"	1"
Solid: AL or CU		-	-	-	-	-
Stirrup Color & Number		Yellow 602104	Yellow 602248	Yellow 602115	Yellow 602174	Yellow 275074
Bail Size		1/0	2/0	4/0	2/0	4/0

Stirrup Selection Thru Wire Stranded	Yellow Shell No. 69338-4 Large Wire Range		
ACSR Standard Round 	715.5, 795.5 54/7, 24/7, 26/7, 30/19, 30/7, 45/7, 795.5 36/1, 874.5 45/7	715.5, 795.5 54/7, 24/7, 26/7, 30/19, 30/7, 45/7, 795.5 36/1, 874.5 45/7	874.5 54/7, 900.0 45/7, 54/7, 954.0 30/7, 954.0, 1033.5 36/1, 45/7, 54/7
AAAC 6201 - 5003 	833.6, 927.2, 932.6	833.6, 927.2, 932.6	—
AAC Standard Round 	795.0, 800.0, 874.5, 900.0, 954.0	795.0, 800.0, 874.5, 900.0, 954.0	1000.0, 1033.5, 1100.0, 1113.0
COPPER Standard Round 	800.0, 850.0, 900.0	800.0, 850.0, 900.0	1000.0
AAC Compressed or Compacted 	954.0	954.0	—
ACSR Compressed or Compacted 	954.0 36/1	954.0 36/1	—
AWAC, ACAR 	819.2, 853.7, 927.2, 983.1 30/7, 840.2, 853.7, 927.2 24/13, 853.7, 862.7, 927.2 18/19	819.2, 853.7, 927.2, 983.1 30/7, 840.2, 853.7, 927.2 24/13, 853.7, 862.7, 927.2 18/19	1012.2 24/13, 1172.0 33/4, 1024.5, 1081.0, 1109.0, 1172.0 30/7, 24/13, 18/19
ALUMOWELD COPPERWELD 	37 No. 6	37 No. 6	—
Galvanized Steel 	—	—	—
Solid: AL or CU 	—	—	—
Stirrup Color & Number	Yellow 602162	Yellow 602163	Yellow 602237
Bail Size	2/0	4/0	4/0





Chapter 2 Identification Solutions

Heat Shrink Markers.....	100
Cable Markers.....	101
Labels.....	103
Portable Marker Kit.....	106
Printers & Accessories	107

ShrinkMark Heat Shrinkable Sleeves

FEATURES

- Shrink ratio of 3:1
- Expanded sleeve diameters from .125" (3.125 mm) to 1.50" (38 mm)
- Sleeves come in 2.00" (50 mm) lengths
- Flame retardant. Sleeves meet UL 224
- Print performance to military requirements
- ShrinkMark sleeves can be supplied pre-scored for a more economical use of material
- Several packaging options to choose from: 250, 1,000 or 2,500 pieces per box
- Standard colors are white and yellow
- Elliptical shape leaves un-shrunk sleeves in place
- Temperature range is -30°C to 105°C

APPLICATIONS

- TE's Raychem ShrinkMark sleeves are suitable for a wide variety of applications. Heat shrinkable sleeves provide legible identification for all types of cables used by electrical contractors and instrumentation control manufacturers.
- ShrinkMark sleeves are ideal for tough industrial environments, including switch gear, motor control centers, and terminal boxes. They shrink faster than conventional thermoplastic tags

BENEFITS

- ♦ ShrinkMark sleeves are extruded from TE's Raychem tubing resulting in a low installed profile with no edges to snag. The cross-linked polyolefin construction makes ShrinkMark sleeves resistant to abrasion, aggressive cleaning solvents, and industrial fluids.

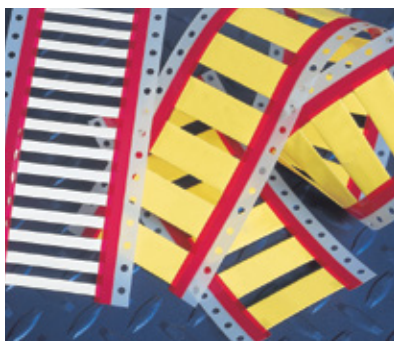

Printers	Ribbons
IDP-T200-PRINTER	IDP-TMS-RJS-RIBN-4RPSCE
IDP-TE3112-PRINTER	IDP-TMS-RJS-RIBN-4RPSCE

PRODUCT SELECTION INFORMATION: DIMENSIONS IN INCHES (MM)

Catalog Number*	Wire Size	Nominal Diameter	Recovered Diameter
ShrinkMark-18-2-9	#22-#18	0.125 (3)	0.042 (1)
ShrinkMark-18-2-S1-9	#22-#18	0.125 (3)	0.042 (1)
ShrinkMark-12-2-9	#18-#12	0.187 (5)	0.062 (2)
ShrinkMark-12-2-S1-9	#18-#12	0.187 (5)	0.062 (2)
ShrinkMark-10-2-9	#16-#10	0.250 (6)	0.083 (2)
ShrinkMark-10-2-S1-9	#16-#10	0.250 (6)	0.083 (2)
ShrinkMark-2-2-9	#10-#2	0.500 (13)	0.167 (4)
ShrinkMark-2-2-S1-9	#10-#2	0.500 (13)	0.167 (4)
ShrinkMark-250-2-9	#1-250	1.00 (25)	0.333 (9)
ShrinkMark-250-2-S1-9	#1-250	1.00 (25)	0.333 (9)
ShrinkMark-1000-2-9	350-1000	1.40 (36)	0.740 (19)
ShrinkMark-1000-2-S1-9	350-1000	1.40 (36)	0.740 (19)

*Replace -9 with -4 if Yellow is needed



UL recognized to
Standard 224



Certified C22.2
No. 198.1

ShrinkMark 10 - 2 - S2 - 9 (1K)

Product name

Largest nominal conductor size in range

Sleeve length in inches

Number of scores

Blank = No scores yields 1 each - 2" marker

S1 = One score yields 2 each - 1" markers per sleeve

S2 = Two scores yield 3 each - 5/8" markers per sleeve

S3 = Three scores yield 4 each - 1/2" markers per sleeve

Standard package

Blank = 250 sleeves per box

(1K) = 1,000 sleeves per box

(2.5K) = 2,500 sleeves per box

Color

4 = Yellow

9 = White

CM-SCE Cable Markers

FEATURES

- Markers are a standard 2" (55 mm) length that come in a .25" (6.25 mm) or .50" (12.7 mm) width
- Flame retardant
- Cable Markers meet UL 224
- Print performance to military requirements
- Standard color is white
- Temperature range is -55°C to 135°C

APPLICATIONS

- TE's Raychem CM-SCE cable markers provide a reliable method of identifying cable, wire bundles, pipes, and conduits.

BENEFITS

- ♦ Simple installation with markers installed using standard nylon tie wraps.



PRODUCT SELECTION INFORMATION: DIMENSIONS IN INCHES (MM)

Catalog Number	Description	Standard Pack	Print Method
IDP-CM-SCE-25-4H-9	.25 Cable Marker, 4 hole	250	Dot Matrix
IDP-CM-SCE-50-4H-9	.5 Cable Marker, 4 hole	250	Dot Matrix
IDP-CM-SCE-50-6H-9	.5 Cable Marker, 6 hole	250	Dot Matrix
IDP-CM-SCE-TP-25-4H-9	.25 Cable Marker, 4 hole	250	Thermal Transfer
IDP-CM-SCE-TP-50-4H-9	.5 Cable Marker, 4 hole	250	Thermal Transfer
IDP-CM-SCE-TP-50-6H-9	.5 Cable Marker, 6 hole	250	Thermal Transfer

Thermal Transfer Printers	Ribbons
IDP-T200-PRINTER	IDP-1966-RIBBON
IDP-TE3112-PRINTER	IDP-1966-RIBBON

HLX-NEL Cable Markers

FEATURES

- Attach using standard cable ties
- Temperature range is -40°C to 105°C
- Perforated edges for easy removal
- Available in White or Yellow

APPLICATIONS

- TE's Raychem HLX markers are assembled in Narrow Edge Leading (NEL) format designed for identification of larger cables and wire bundles

BENEFITS

- ♦ Markers are manufactured from low fire hazard polyolefin material making them ideal in applications where low smoke, low toxicity and zero halogen are critical.



PRODUCT SELECTION INFORMATION: DIMENSIONS IN INCHES (MM)

Catalog Number	Marker Dimensions	Printable Area	Markers Across	Standard Pack
IDP-HLX125WE4NEL60S	3.15 x 0.49 (80 x 12.5)	2.35 x 0.4 (60 x 10.50)	4	200
IDP-HLX125WE2NEL60S	3.15 x 0.49 (80 x 12.5)	2.35 x 0.4 (60 x 10.50)	2	200
IDP-HLX125YW4NEL60S	3.15 x 0.49 (80 x 12.5)	2.35 x 0.4 (60 x 10.50)	4	200
IDP-HLX125YW2NEL60S	3.15 x 0.49 (80 x 12.5)	2.35 x 0.4 (60 x 10.50)	2	200

Thermal Transfer Printers	Ribbons
IDP-T200-PRINTER	IDP-1966-RIBBON
IDP-TE3112-PRINTER	IDP-1966-RIBBON

Permark Pre-Printed 316 Stainless Steel Markers

FEATURES

- Pre-marked to customer requirements
- Transfer of data files electronically
- Excellent chemical, abrasion, corrosion, and weather resistance
- One-piece, 316 stainless steel construction
- Stainless steel cable ties are also available
- Temperature range is -80°C to 500°C

APPLICATIONS

- Permark stainless steel markers and identification plates are designed to withstand the most hostile environments.

BENEFITS

- ♦ Using state-of-the-art technology and no inks, the marking process produces a permanent, deep surface mark. Permark markers are produced for individual customer requirements on a fast turn-around basis.



PRODUCT SELECTION INFORMATION: DIMENSIONS IN INCHES (MM)

Catalog Number	Description	Standard Pack
IDP-PM09512	Stainless Steel 4 mm, 3.74 x 0.47 (95 x 12) marker - Pre-Printed (max 25 characters)	1
IDP-PM09512-BLANK	Stainless Steel 4 mm, 3.74 x 0.47 (95 x 12) marker - Blank	1
IDP-PM07507	Stainless Steel 4 mm, 2.95 x 0.28 (75 x 7) marker - Pre-Printed (max 20 characters)	1
IDP-PM07507-BLANK	Stainless Steel 4 mm, (75 x 70) marker - Blank	1
IDP-SST141-316	SS cable tie 0.18 x 14.3 (4.6 x 360), Ties/Pack 100	100
IDP-SST71-316	SS cable tie 0.18 x 7.9 (4.6 x 200), Ties/Pack 100	100

Self-Laminating Labels

FEATURES

- Vinyl material with acrylic adhesive
- UL recognized for indoor use
- Temperature Range: -40°C to 80°C

APPLICATIONS

- TE's Raychem Self-Laminating labels offer a fast and inexpensive way to identify wire and cable.

BENEFITS

- ♦ Self-Laminating labels offer a white area for printed or handwritten information and a clear wrap that winds around and protects the information
- ♦ Protects printed information from chemicals and frequent handling
- ♦ Designed to withstand exposure to oil, solvents, and water



Printers	Ribbons
IDP-T200-PRINTER	IDP-TMS-RJS-RIBN-4RPSCE
IDP-TE3112-PRINTER	IDP-TMS-RJS-RIBN-4RPSCE

PRODUCT SELECTION INFORMATION: DIMENSIONS IN INCHES (MM)

Catalog Number	Maximum Cable OD	Print Area Height	Label Width	Label Height	Labels/Roll
IDP-SB050100WE10	.20 (5.1)	.33 (8.5)	.50 (12.7)	1.00 (25.4)	10,000
IDP-SB050143WE10	.30 (7.6)	.50 (12.7)	.50 (12.7)	1.437 (36.5)	10,000
IDP-SB100143WE5	.30 (7.6)	.50 (12.7)	1.00 (25.4)	1.437 (36.5)	5,000
IDP-SB200143WE2.5	.30 (7.6)	.50 (12.7)	2.00 (50.8)	1.437 (36.5)	2,500
IDP-SB080150WE10	.30 (7.6)	.50 (12.7)	.80 (20.3)	1.50 (38.1)	10,000
IDP-SB100225WE5	.48 (12.2)	.75 (19)	1.00 (24.4)	2.25 (57.2)	5,000
IDP-SB200225WE2.5	.48 (12.2)	.75 (19)	2.00 (50.8)	2.25 (57.2)	2,500
IDP-SB100375WE2.5	.88 (22.4)	1.00 (25.4)	1.00 (25.4)	3.75 (95.3)	2,500
IDP-SB200375WE2.5	.88 (22.4)	1.00 (25.4)	2.00 (50.8)	3.75 (95.3)	2,500
IDP-SB100594WE1	1.40 (35.5)	1.50 (38.1)	1.00 (25.4)	5.94 (151)	1,000
IDP-SB190594WE1	1.40 (35.5)	1.50 (38.1)	1.90 (48.3)	5.94 (151)	1,000
IDP-SB200743WE1	1.90 (48.3)	1.50 (38.1)	2.00 (50.8)	7.437 (189)	1,000

Recommended for use with the TE3112 and T200 Printers.

Catalog Number	Maximum Cable OD	Print Area Height	Label Width	Label Height	Labels/Roll
T200 Size Rolls					
IDP-SB050100WE5-T200	.20 (5.1)	.33 (8.5)	.50 (12.7)	1.00 (25.4)	5,000
IDP-SB050143WE5-T200	.30 (7.6)	.50 (12.7)	.50 (12.7)	1.437 (36.5)	5,000
IDP-SB100143WE2.5-T200	.30 (7.6)	.50 (12.7)	1.00 (25.4)	1.437 (36.5)	2,500
IDP-SB080150WE5-T200	.30 (7.6)	.50 (12.7)	.80 (20.3)	1.50 (38.1)	5,000
IDP-SB100225WE2.5-T200	.48 (12.2)	.75 (19)	1.00 (25.4)	2.25 (57.2)	2,500
IDP-SB200225WE1-T200	.48 (12.2)	.75 (19)	2.00 (50.8)	2.25 (57.2)	1,000
IDP-SB100375WE1-T200	.88 (22.4)	1.00 (25.4)	1.00 (25.4)	3.75 (95.3)	1,000
IDP-SB200375WE1-T200	.88 (22.4)	1.00 (25.4)	2.00 (50.8)	3.75 (95.3)	1,000
IDP-SB100594WE0.5-T200	1.40 (35.5)	1.50 (38.1)	1.00 (25.4)	5.94 (151)	500
IDP-SB200743WE0.5-T200	1.90 (48.3)	1.50 (38.1)	2.00 (50.8)	7.734 (189)	500

These labels have a smaller core that allows them to fit inside of the T208 Printer.

Pressure Sensitive Polyester Labels

FEATURES

- No heat curing process required
- Excellent for bar coding, PCB and component labeling applications
- Multiple die-cut sizes available
- MP = Metalized Polyester
- WP = White Polyester
- Temperature range is -40°C to 150°C

APPLICATIONS

- WP labels are ideal for bar coding, PCB and component labeling, and other general purpose applications that require a durable white label.
- MP Labels are ideal for applications that require a metallic appearance, such as nameplates, equipment labels, and serial number plates.

BENEFITS

- ♦ TE's Pressure Sensitive Polyester labels contain a permanent acrylic adhesive providing an excellent, durable bond to many surfaces including tubing, wiring, cables, or panels.



Printers	Ribbons
IDP-T200-PRINTER	IDP-1330-0607-10
IDP-TE3112-PRINTER	IDP-1330-0607-10

PRODUCT SELECTION INFORMATION: DIMENSIONS IN INCHES (MM)

Catalog Number	Label Width	Label Height	Material	Labels per Rolls
IDP-MP-191064-10-8A	0.75 (19)	0.25 (6.4)	Metalized Polyester	10,000
IDP-MP-203127-10-8A	0.80 (20.3)	0.50 (12.7)	Metalized Polyester	10,000
IDP-MP-254127-10-8A	1.00 (25.4)	0.50 (12.7)	Metalized Polyester	10,000
IDP-MP-254254-10-8A	1.00 (25.4)	1.00 (25.4)	Metalized Polyester	10,000
IDP-MP-381064-10-8A	1.50 (38.1)	0.25 (6.4)	Metalized Polyester	10,000
IDP-MP-381191-5-8A	1.50 (38.1)	0.75 (19)	Metalized Polyester	5,000
IDP-MP-508254-5-8A	2.00 (50.8)	1.00 (25.4)	Metalized Polyester	5,000
IDP-MP-508318-2.5-8A	2.00 (50.8)	1.25 (31.8)	Metalized Polyester	2,500
IDP-MP-699254-5-8A	2.75 (70)	1.00 (25.4)	Metalized Polyester	5,000
IDP-MP-762381-2.5-8A	3.00 (76.2)	1.50 (38.1)	Metalized Polyester	2,500
IDP-MP-762508-2.5-8A	3.00 (76.2)	2.00 (50.8)	Metalized Polyester	2,500
IDP-MP-101635-2.5-8A	4.00 (101.6)	2.50 (63.5)	Metalized Polyester	2,500
IDP-WP-040040-25-9	0.157 (4)	0.157 (4)	White Polyester	25,000
IDP-WP-064064-25-9	0.25 (6.4)	0.25 (6.4)	White Polyester	25,000
IDP-WP-080080-10-9	0.315 (8)	0.315 (8)	White Polyester	10,000
IDP-WP-950950-10-9	0.375 (9.5)	0.375 (9.5)	White Polyester	10,000
IDP-WP-114040-25-9	0.45 (11.4)	0.157 (4)	White Polyester	25,000
IDP-WP-127111-10-9	0.50 (12.7)	0.437 (11.1)	White Polyester	10,000
IDP-WP-165102-10-9	0.65 (16.5)	0.40 (10.2)	White Polyester	10,000
IDP-WP-165051-25-9	0.65 (16.5)	0.20 (5.1)	White Polyester	25,000
IDP-WP-178095-10-9	0.70 (17.8)	0.375 (9.5)	White Polyester	10,000
IDP-WP-191064-10-9	0.75 (19)	0.25 (6.4)	White Polyester	10,000
IDP-WP-203127-10-9	0.80 (20.3)	0.50 (12.7)	White Polyester	10,000
IDP-WP-229064-10-9	0.90 (22.9)	0.25 (6.4)	White Polyester	10,000
IDP-WP-254097-10-9	1.00 (25.4)	0.38 (9.7)	White Polyester	10,000
IDP-WP-254127-10-9	1.00 (25.4)	0.50 (12.7)	White Polyester	10,000
IDP-WP-254254-10-9	1.00 (25.4)	1.00 (25.4)	White Polyester	10,000
IDP-WP-318064-10-9	1.25 (31.8)	0.25 (6.4)	White Polyester	10,000
IDP-WP-381020-10-9	1.50 (38.1)	0.08 (2)	White Polyester	10,000
IDP-WP-381064-10-9	1.50 (38.1)	0.25 (6.4)	White Polyester	10,000
IDP-WP-381191-5-9	1.50 (38.1)	0.75 (19)	White Polyester	5,000
IDP-WP-508127-5-9	2.00 (50.8)	0.5 (12.7)	White Polyester	10,000
IDP-WP-508254-5-9	2.00 (50.8)	1.00 (25.4)	White Polyester	5,000
IDP-WP-508318-2.5-9	2.00 (50.8)	1.25 (31.8)	White Polyester	2,500
IDP-WP-508064-10-9	2.00 (50.8)	0.25 (6.4)	White Polyester	10,000
IDP-WP-523841-1.5-9	2.06 (52.3)	3.31 (84.1)	White Polyester	1,500
IDP-WP-700254-5-9	2.75 (70)	1.00 (25.4)	White Polyester	5,000
IDP-WP-762381-2.5-9	3.00 (76.2)	1.50 (38.1)	White Polyester	2,500
IDP-WP-762508-2.5-9	3.00 (76.2)	2.0 (50.8)	White Polyester	2,500
IDP-WP-101635-2.5-9	4.00 (101.6)	2.50 (63.5)	White Polyester	2,500
IDP-WP-101165-0.85-9	4.00 (101.6)	6.50 (165)	White Polyester	900

ProjectMark Continuous Labels

FEATURES

- High tack acrylic adhesive
- Resistant to moisture/humidity
- 4 printable continuous widths in several colors
- Material comes on a 100' reel and ranges from 1.0" (25 mm) to 4.0" (100 mm) wide
- Standard white ProjectMark labels have a 5 - 7 year outdoor life
- Temperature range is -40°C to 150°C
- Standard Colors are White (WE) and Metalized Polyester (MP). Additional colors include the following:
OE = Orange, GN = Green, BE = Blue, RD = Red, BK = Black, YW = Yellow, CL = Clear.

APPLICATIONS

- TE's Raychem ProjectMark (TPPA) is a durable, high strength polyester material that can be used as warning and service labels, rating plates, and a way to identify cable trays—all of which can be produced on demand.

BENEFITS

- Efficient alternate solution to expensive silk-screen printing.

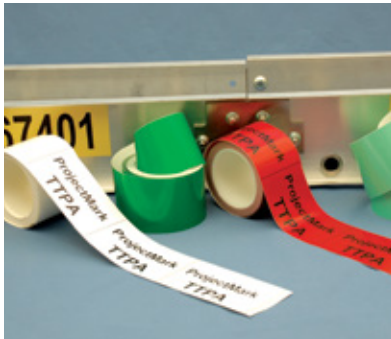

PRODUCT SELECTION INFORMATION

Catalog Number	Description	Color	Standard Pack
IDP-TTPA100WE-10*	Continuous Polyester 100 Ft Roll - 1" Wide	White (WE)	1
IDP-TTPA100YW-10*	Continuous Polyester 100 Ft Roll - 1" Wide	Yellow (YW)	1
IDP-TTPA200MP-10	Continuous Polyester 100 Ft Roll - 2" Wide	Metalized Poly (MP)	1
IDP-TTPA200WE-10	Continuous Polyester 100 Ft Roll - 2" Wide	White (WE)	1
IDP-TTPA300MP-10	Continuous Polyester 100 Ft Roll - 3" Wide	Metalized Poly (MP)	1
IDP-TTPA300WE-10	Continuous Polyester 100 Ft Roll - 3" Wide	White (WE)	1
IDP-TTPA400MP-10	Continuous Polyester 100 Ft Roll - 4" Wide	Metalized Poly (MP)	1
IDP-TTPA400WE-10	Continuous Polyester 100 Ft Roll - 4" Wide	White (WE)	1

*1 inch wide rolls are only available in White and Yellow.

LM2020 PLUS Portable Hand-Held Marking Kit

FEATURES

- Minimum media width of 0.125" (3.2 mm). Maximum media width of 1.0" (25 mm)
- 67 point size ranging from 6 point to 72 point
- 10 resident bar codes
- Alphanumeric sequencing
- Battery-operated or AC power supply-operated
- Product and ribbon comes housed in easy-to-install cartridges

APPLICATIONS

- The TE's Raychem LM2020 Plus system is an advanced portable thermal label printer designed for labeling and bar coding applications in the field, office, or shop. The LM2020 Plus marker material and ribbon are pre-loaded into a snap-in cartridge. This allows for repeatable, error free loading into the printer.

BENEFITS

- ♦ No smearing—Ink dries immediately
- ♦ Marker material and ribbon are pre-loaded into a snap-in cartridge allowing for easy, error-free loading into the printer
- ♦ 300 dpi thermal print quality—Superior print quality compared to 9-pin dot matrix printers
- ♦ Savings—Very affordable portable thermal printing system



PRODUCT SELECTION INFORMATION

Catalog Number	Label Width	Standard Pack
LM2020PLUS-PRINTER-KIT	Handheld printer, protective jacket, 6 ni-cad batteries	1
LM2020PLUS-2500MAH-NICAD	LM 2020 Rechargeable Batteries	1
LM-CASE	LM 2020 Hard Sided Carrying Case	1
LM-1/8-TUBE-WE	Shrinktube .125" x 100" Cartridge, White #16-#22	1
LM-1/8-TUBE-YW	Shrinktube .125" x 100" Cartridge, Yellow #16-#22	1
LM-3/16-TUBE-WE	Shrinktube .1875" x 100" Cartridge, White #12-#18	1
LM-3/16-TUBE-YW	Shrinktube .1875" x 100" Cartridge, Yellow #12-#18	1
LM-1/4-TUBE-WE	Shrinktube .25" x 100" Cartridge, White #10-#16	1
LM-1/4-TUBE-YW	Shrinktube .25" x 100" Cartridge, Yellow #10-#16	1
LM-1/2-TUBE-WE	Shrinktube .5" x 100" Cartridge, White #1-#12	1
LM-1/2-TUBE-YW	Shrinktube .5" x 100" Cartridge, Yellow #1-#12	1
LM-1/2-VINYL-WE	.5" x 40' Vinyl Industrial Tape-Black on White	1
LM-1/2-VINYL-YW	.5" x 40' Vinyl Industrial Tape-Black on Yellow	1
LM-1-VINYL-WE	1" x 40' Vinyl Industrial Tape-Black on White	1
LM-1-VINYL-YW	1" x 40' Vinyl Industrial Tape-Black on Yellow	1
LM-1/2-SL	Self-Lam 1" x .50", Print Area 1" x .25", 230 each. Fits #16-#22	1
LM-3/4-SL	Self-Lam 1" x .75", Print Area 1" x .375", 250 each. Fits #10-#16	1
LM-1-SL	Self-Lam 1" x 1", Print Area 1" x .375", 200 each. Fits #10-#12	1
LM-1-1/4-SL	Self-Lam 1" x 1.25", Print Area 1" x .50", 170 each. Fits #8-#12	1
LM-2-1/2-SL	Self-Lam 1" x 2.50", Print Area 1" x .75", 108 each. Fits #6-#10	1
LM-4-SL	Self-Lam 1" x 4", Print Area 1" x 1", 81 each. Fits #4-#6	1

T200 Thermal Transfer Printers

FEATURES

- 300 dpi print-head suitable for alphanumeric texts, linear barcodes, and simple graphics
- Uses TE standard ribbons
- Adjustable label sensor
- Multiple language selection
- Intuitive touch screen
- Print speed up to 125 mm/s
- Cutter and Perforator are available

APPLICATIONS

- The T200 Ident printer is a medium volume, cost-effective thermal transfer printer with a small footprint that is ideal for office or light industrial labeling needs.
- Suitable for printing on printable tubing, tags, and adhesive labels.

BENEFITS

- ♦ Light-weight
- ♦ Simple ribbon and media loading procedure
- ♦ Automatic calibration
- ♦ Superior print position accuracy



PRODUCT SELECTION INFORMATION

Catalog Number	Description	Standard Pack
IDP-T200-PRINTER	Low to mid volume ident printer, 300 dpi, 105.7Mm max print width	1
IDP-T200-PERFORATOR	Perforate print media to a set depth and length	1
IDP-T200-CUTTER	Accurately and cleanly cuts set-lengths of continuous tube and labels	1

TE3112 Thermal Transfer Printer

FEATURES

- Approved to print the entire range of TE thermal transfer identification products
- For printing high quality texts, graphic images and barcodes
- For use with TE-approved WinTotal software packages
- Cutter or perforating accessories available

APPLICATIONS

- The TE3112-PRINTER is a high performance mid-range Identification printer for marking heat-shrinkable marker sleeves, cable marker tags, and labels.

BENEFITS

- ♦ Robust print engine and design makes it well suited for use in higher volume commercial and industrial environments.



PRODUCT SELECTION INFORMATION

Catalog Number	Description	Standard Pack
IDP-TE3112-PRINTER	High Performance Ident Printer, 300 dpi	1
IDP-TTC-PRINT-PERFORATOR	Perforate print media to a set depth and length	1
IDP-TTC-PRINTER-CUTTER	Accurately and cleanly cuts set-lengths of continuous tube and labels	1

WinTotal Software

FEATURES

- WinTotal software makes printing easy with live database view in fields and true print preview.
- Multi-lingual user interface
- Pre-loaded WYSIWYG templates
- Clipart gallery with over 1000 commonly used symbols
- Incremental alpha and numeric fields
- Accepts and prints data in any language
- Multiple printers - print simultaneous
- Advanced label design elements and tools

APPLICATIONS

- WinTotal software is pre-loaded with all the TE wire identification products and a 14 day trial can be downloaded from the TE website. Following the trial, a license or access dongle must be purchased.

BENEFITS

- ♦ WinTotal software is a powerful Windows software based package that makes identification marking quick and easy.

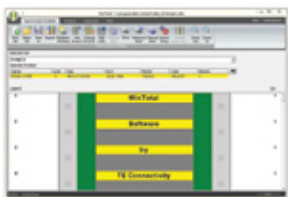

PRODUCT SELECTION INFORMATION

Catalog Number	Description	Standard Pack
IDP-WINTOTAL-6-SWARE-DGL	WinTotal Software with USB Dongle	1

Ribbons

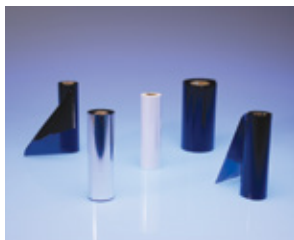

PRODUCT SELECTION INFORMATION

Printer	Ribbons	Print Media
T200-IDENT-PRINTER	IDP-TMS-RJS-RIBN-4RPSCE	ShrinkMark sleeves & SB labels
	IDP-1330-0607-10	TTPA, MP, WP labels
	IDP-1996-RIBBON	CM-SCE, HLX-NEL cable markers
TE3112-PRINTER	IDP-TMS-RJS-RIBN-4RPSCE	ShrinkMark sleeves & SB labels
	IDP-1330-0607-10	TTPA, MP, WP labels
	IDP-1996-RIBBON	CM-SCE, HLX-NEL cable markers

Catalog Number	Description	Standard Pack
IDP-TMS-RJS-RIBN-4RPSCE	High durability, commercial grade black thermal transfer ribbon for use with ShrinkMark sleeves & SB labels	1
IDP-1330-0607-10	High durability black resin thermal transfer printable ribbon for use on pressure sensitive labels.	1
IDP-1996-RIBBON	Ultra-high performance black thermal transfer ribbon for use with CM-SCE and HLX-NEL cable markers	1

Reel Holder

FEATURES

- Accessories: Reel Holder Adaptors

APPLICATIONS

- The Universal reel holder is a free standing bench top or wall-mounted reel holder designed to dispense all TE identification marker sleeves, cable markers, and labels.

BENEFITS

- ♦ This robust metal, low cost reel holder replaces all other TE Printer reel holders and is compatible with the complete TE printer range.

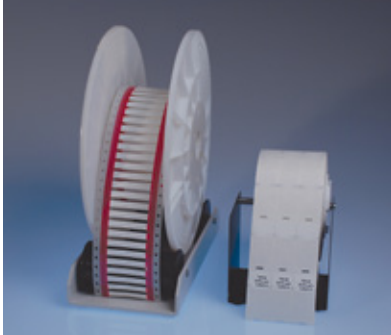

PRODUCT SELECTION INFORMATION

Catalog Number	Description	Standard Pack
PRINTER-UNIVERSAL-REEL-HOLDER	Dispenses all TE identification marker sleeves, cable markers, and labels	1
PRINTER-UNIVERSAL-REEL-HOLDER-ADAPTORS	Holds the reel in place on the Universal reel holder	1



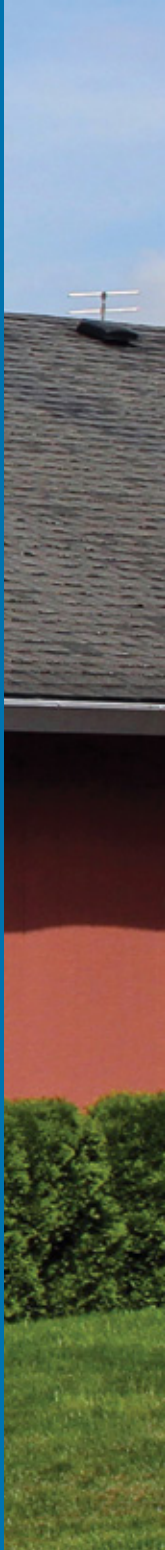

Chapter 3

TE's Raychem Low Voltage Splices & Taps

Low Voltage In-line Splices	
Heat Shrink	112
Cold Applied	120
Low Voltage Taps	124
Network Protection	131

MWTM Medium-Wall Sealant-Coated or Uncoated Tubing

FEATURES

- TE's Raychem MWTM Tubing is RUS accepted as jacket restoration of JCN cable
- 3:1 shrink ratio and an unlimited shelf life when stored under normal conditions

APPLICATIONS

- Sealant-coated MWTM tubing (-S designation) is for use as insulation/ jacket repair up to 600 V or for general sealing and re-jacketing of polymeric- or elastomeric-insulated cables up to 35 kV
- Uncoated MWTM tubing (-U or -A/U) is for cable re-jacketing only

BENEFITS

- Designed to Match Cable Performance
- Range Taking
- Conforms to Substrate
- Smallest Installed Profile
- Quick Installation
- Unlimited Shelf Life
- Cut to Length at Job Site



PRODUCT SELECTION INFORMATION: DIMENSIONS IN INCHES (MM)

Catalog Number	Use Range (min - max)	Cut-Piece Length	Min. Cont. Length	Standard Package		
				Box	Spool	Bulk Spool
Sealant-Coated, Cut-Length Tubing						
MWTM-10/3-1200-S	0.13-0.35 (3-9)	48 (1200)		25		
MWTM-16/5-1200-S	0.25-0.55 (6-14)	48 (1200)		25		
MWTM-25/8-1200-S	0.35-0.85 (9-22)	48 (1200)		25		
MWTM-35/12-1200-S	0.50-1.25 (13-32)	48 (1200)		25		
MWTM-50/16-1200-S	0.65-1.70 (17-43)	48 (1200)		15		
MWTM-85/25-1200-S	1.00-2.90 (25-74)	48 (1200)		5		
MWTM-115/34-1200-S	1.40-3.90 (36-99)	48 (1200)		5		
MWTM-140/42-1200-S	1.80-4.70 (46-119)	48 (1200)		5		
Uncoated, Spooled Tubing						
MWTM-10/3-A/U	0.13-0.35 (3-9)		25 (7.6)		100 (30)	
MWTM-16/5-A/U	0.25-0.55 (6-14)		25 (7.6)		100 (30)	1155 (350)
MWTM-25/8-A/U	0.35-0.85 (9-22)		25 (7.6)		100 (30)	660 (200)
MWTM-35/12-A/U	0.50-1.25 (13-32)		25 (7.6)		100 (30)	495 (150)
MWTM-50/16-A/U	0.65-1.70 (17-43)		15 (4.6)		75 (23)	330 (100)
Uncoated, Cut Length Tubing						
MWTM-85/25-1500/U	1.00-2.90 (25-74)	60 (1500)		5		
MWTM-115/34-1500/U	1.40-3.90 (36-99)	60 (1500)		5		
MWTM-140/42-1500/U	1.80-4.70 (46-119)	60 (1500)		5		

ADDITIONAL PRODUCT INFORMATION

- Select the appropriate catalog number. Confirm selection with application dimensions to assure proper sizing.
- MWTM is a general purpose tubing; for sealing applications use MWTM with sealant (-S) or use uncoated MWTM (-U or -A/U) in combination with S-1052 sealant. Order sealants separately.
- For testing information refer to the Technical Data section of this catalog.
- UV resistant test report: EDR-5361.

For connector information refer to the Connectors and Terminals section of this catalog.

WCSM Heavy-Wall Sealant Coated Tubing (1000 V)

FEATURES

- 4:1 shrink ratio
- TE's Raychem WCSM tubing is UL and cUL listed per 486D (file E91151) for sizes 12/3 through 70/20.
- Qualified to ANSI C119.1 and rated to Western Underground guide 2.5.
- RUS accepted for use as a secondary tap or splice cover, and for use as jacket restoration materials on JCN cable.

APPLICATIONS

- Seal an in-line splice or terminal lug seal for non-flame retardant applications, cable re-jacketing and mechanical protection.
- Jacket repair on cables up to 35 kV.
- For use on standard poly or elastomeric insulated / jacketed cable or lead-jacketed cables, which may include aluminum or steel armoring.

BENEFITS

- Designed to Match Cable Performance
- Range Taking
- Conforms to Substrate
- Smallest Installed Profile
- Quick Installation
- Unlimited Shelf Life
- Cut to Length at Job Site

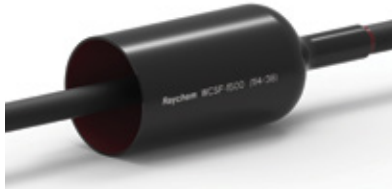

Wire Connector System for
use with Underground Connectors
96J4

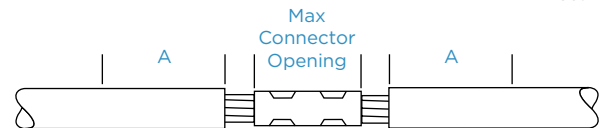

3

PRODUCT SELECTION INFORMATION: DIMENSIONS IN INCHES (MM)

Catalog Number	1000V Cable Nominal Use Range AWG/kcmil Min - Max	Maximum Connector O.D.	UL Conductor Use Range Min - Max	General Conductor Use Range Min - Max	Max Connector Opening	Min Seal Length per Side A
WCSM-12/3-150-S	#14-#6	0.29	.13-.30 (3.5-7.7)	.13-.39 (3.5-10)	2.4	1.5
WCSM-12/3-300-S	#14-#6	0.29	.13-.30 (3.5-7.7)	.13-.39 (3.5-10)	7.8	1.5
WCSM-12/3-1200-S	#14-#6	0.29	.13-.30 (3.5-7.7)	.13-.39 (3.5-10)	39.3	1.5
WCSM-16/4-150-S	#8-#2	0.41	.17-.41 (4.5-10.5)	.17-.55 (4.5-14)	1.4	2
WCSM-16/4-300-S	#8-#2	0.41	.17-.41 (4.5-10.5)	.17-.55 (4.5-14)	6.8	2
WCSM-16/4-1200-S	#8-#2	0.41	.17-.41 (4.5-10.5)	.17-.55 (4.5-14)	38.3	2
WCSM-24/6-150-S	#6-#4/0	0.69	.25-.64 (6.5-16.5)	.25-.86 (6.5-22)	1.4	2
WCSM-24/6-225-S	#6-#4/0	0.69	.25-.64 (6.5-16.5)	.25-.86 (6.5-22)	3.96	2
WCSM-24/6-300-S	#6-#4/0	0.69	.25-.64 (6.5-16.5)	.25-.86 (6.5-22)	6.8	2
WCSM-24/6-1200-S	#6-#4/0	0.69	.25-.64 (6.5-16.5)	.25-.86 (6.5-22)	38.3	2
WCSM-34/8-150-S	#2-500	1.06	.35-.94 (9-24)	.35-1.22 (9-31)	1.4	2
WCSM-34/8-200-S	#2-500	1.06	.35-.94 (9-24)	.35-1.22 (9-31)	3.02	2
WCSM-34/8-225-S	#2-500	1.06	.35-.94 (9-24)	.35-1.22 (9-31)	3.96	2
WCSM-34/8-300-S	#2-500	1.06	.35-.94 (9-24)	.35-1.22 (9-31)	6.8	2
WCSM-34/8-1200-S	#2-500	1.06	.35-.94 (9-24)	.35-1.22 (9-31)	38.48	2
WCSM-48/12-150-S	#2/0-750	1.3	.51-1.12 (13-28.5)	.51-1.73 (13-44)	1.4	2
WCSM-48/12-225-S	#2/0-750	1.3	.51-1.12 (13-28.5)	.51-1.73 (13-44)	3.96	2
WCSM-48/12-300-S	#2/0-750	1.3	.51-1.12 (13-28.5)	.51-1.73 (13-44)	6.8	2
WCSM-48/12-1200-S	#2/0-750	1.3	.51-1.12 (13-28.5)	.51-1.73 (13-44)	38.3	2
WCSM-56/16-225-S	250-1000	1.5	.68-1.27 (17.5-32.5)	.70-1.96 (17.5-50)	3.96	2
WCSM-56/16-300-S	250-1000	1.5	.68-1.27 (17.5-32.5)	.70-1.96 (17.5-50)	6.62	2
WCSM-56/16-1200-S	250-1000	1.5	.68-1.27 (17.5-32.5)	.70-1.96 (17.5-50)	38.3	2
WCSM-70/20-300-S	500-500	1.84	.92-1.40 (22-35.8)	.86-2.48 (22-63)	5.8	2.5
WCSM-70/20-450-S	500-1500	1.84	.92-1.40 (22-35.8)	.86-2.48 (22-63)	10.93	2.5
WCSM-70/20-600-S	500-1500	1.84	.92-1.40 (22-35.8)	.86-2.48 (22-63)	16.26	2.5
WCSM-70/20-1200-S	500-1500	1.84	.92-1.40 (22-35.8)	.86-2.48 (22-63)	37.3	2.5
WCSM-110/30-300-S	800-2000	-	-	1.29-3.93 (33-100)		2.5
WCSM-110/30-1200-S	800-2000	-	-	1.29-3.93 (33-100)		2.5
WCSM-130/35-300-S	1500-2500	-	-	1.49-4.64 (39-118)		2.5
WCSM-130/35-450-S	1500-2500	-	-	1.49-4.64 (39-118)		2.5
WCSM-130/35-1200-S	1500-2500	-	-	1.49-4.64 (39-118)		2.5

ADDITIONAL PRODUCT INFORMATION

- Select the appropriate catalog number based on typical dimensions for low-voltage insulated cable. Confirm selection with dimensions to assure proper sizing. For general conductor use or UL conductor use.
- Package does not contain connectors or lugs. Installed connector or lug diameter must be within use range.
- TE's Raychem WCSM tubing may be field-cut for shorter requirements
- Bulk packaging is available for cut lengths. Consult your TE representative for more information.
- UL listing applies to WCSM-12/3 through -70/20 only. WCSM-110/30 and -130/35 are not UL listed.
- Related test reports: EDR 5541, PII 56428

FCSM Heavy-Wall Flame Retardant Tubing (2000 V)

FEATURES

- TE's Raychem FCSM tubing is flame retardant
- 3:1 shrink ratio
- Qualified to ANSI C119.1 also rated to IEEE 383 (Vertical Tray Flame Test) and ICEA S-19-81.
- MSHA approved (No. 07-KA090013-MSHA).

APPLICATIONS

- Use sealant-coated tubing (-S) as a sealed in-line splice or terminal lug seal.
- Use uncoated tubing (-/U) for cable rejacketing only
- Sealant-coated or uncoated tubing may be used for jacket repair on cable to 35 kV
- For use on standard poly- or elastomeric-insulated/jacketed cables or lead jacketed cables (aluminum or steel armoring)
- Used for electrical insulation of cables up to 2000V

BENEFITS

- Designed to Match Cable Performance
- Range Taking
- Conforms to Substrate
- Quick Installation
- Unlimited Shelf Life
- Cut to Length at Job Site
- Unlimited shelf life when stored in normal conditions

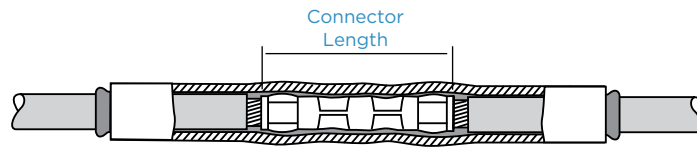

Connectors up to 6 inches: Recommended cut length = connector length + 4 inches
Connectors > 6 inches: Recommended cut length = connector length + 5 inches

PRODUCT SELECTION INFORMATION: DIMENSIONS IN INCHES (MM)

Catalog Number	2000 V Insulated Conductor Size (AWG/kcmil)	General Use Range (min - max)	Tube Length*	Standard Package		
				Ft. (m)/Roll	Pcs/Box	Ft. (m)/Roll
In-Line Splice Or Terminal Lug Seal (With Sealant)						
FCSM-9/3-1200-S	#14-#8	0.15-0.30 (4-8)	48 (1200)		25	
FCSM-19/6-150-S	#6-#2	0.25-0.65 (6-17)	6 (150)		50	
FCSM-19/6-1200-S	#6-#2	0.25-0.65 (6-17)	48 (1200)		25	
FCSM-28/9-225-S	#2-4/0	0.40-0.95 (10-24)	9 (225)		50	
FCSM-28/9-1200-S	#2-4/0	0.40-0.95 (10-24)	48 (1200)		25	
FCSM-38/12-300-S	1/0-350	0.50-1.30 (13-33)	12 (300)		40	
FCSM-38/12-1200-S	1/0-350	0.50-1.30 (13-33)	48 (1200)		10	
FCSM-51/16-300-S	250-500	0.70-1.75 (18-44)	12 (300)		30	
FCSM-51/16-1200-S	250-500	0.70-1.75 (18-44)	48 (1200)		10	
FCSM-68/22-1200-S	600-1000	0.95-2.30 (25-58)	48 (1200)		10	
FCSM-90/30-1200-S	800-1200	1.30-3.10 (33-79)	48 (1200)		5	
FCSM-120/40-1200-S	1500-2500	1.75-4.10 (44-104)	48 (1200)		5	
FCSM-177/63 600-S		2.75-6.05 (70-154)	24 (600)		6	
FCSM-177/63-1200-S		2.75-6.05 (70-154)	48 (1200)		5	
Cable Rejacketing (Without Sealant)						
FCSM-9/3-A/U	#14-#8	0.15-0.30 (4-8)		100 (30)		
FCSM-19/6-A/U	#6-#2	0.25-0.65 (6-17)		100 (30)		825 (250)
FCSM-28/9-A/U	#2-4/0	0.40-0.95 (10-24)		65 (20)		495 (150)
FCSM-38/12-A/U	1/0-350	0.50-1.30 (13-33)		50 (15)		395 (120)
FCSM-51/16-A/U	250-500	0.70-1.75 (18-44)		40 (12)		330 (100)
FCSM-68/22-A/U	600-1000	0.95-2.30 (25-58)		80 (24)		
FCSM-90/30-1500/U	800-1200	1.30-3.10 (33-79)	60 (1500)		5	
FCSM-120/40-1500/U	1500-2500	1.75-4.10 (44-104)	60 (1500)		5	
FCSM-177/63-1500/U		2.75-6.05 (70-154)	60 (1500)		5	

*Length tolerance to +/- 2%.

ADDITIONAL PRODUCT INFORMATION

- Select the appropriate catalog number based on typical dimensions for low-voltage insulated cable. Confirm selection with cable dimensions to assure proper sizing.
- Connectors or lugs not included.
- If sealing is needed with uncoated FCSM tubing (-/U), order S1052 separately.
- Bulk packaging is available for cut-lengths. Contact your TE Connectivity representative for additional information.
- Designed to Match Cable Performance
- Related test reports: EDR-5133, EDR-5134, EDR-5141, EDR-5499.

LVSA-3 Heat Shrink Splice for 3/C Armored Cable (1000 V)

FEATURES

- TE's Raychem LVSA-3 is a Low-profile wraparound armor case that is simple to install and requires no compound or resin filling.
- Qualified to ANSI C119.1

APPLICATIONS

- Splicing 3/C polymeric, armored (corrugated or interlocked-type) power and control cables (600-1000 volts).

BENEFITS

- ♦ Heat shrinkable, adhesive-coated outer sleeve that significantly reduces the installation space required and protects the splice from corrosion and moisture.



PRODUCT SELECTION INFORMATION: DIMENSIONS IN INCHES (MM)

Catalog Number	Conductor Size Range (AWG/kcmil)	Cable O.D. (min - max)	Maximum Connector Length	Standard Pack
LVSA-3-1	#6-#2	0.60-1.50 (15-38)	3.50 (89)	1
LVSA-3-2	#1-4/0	0.90-2.20 (23-56)	4.00 (102)	1
LVSA-3-3	250-500	1.20-3.00 (30-76)	5.00 (127)	1
LVSA-3-4	600-1000	1.50-3.80 (38-97)	7.00 (178)	1

Kits do not contain connectors; please order them separately.

CRSM Heat Shrink Wraparound Sleeve (1000 V)

FEATURES

- All of TE's Raychem CRSM sleeves are sealant-coated.
- Qualified to ANSI C119.1
- Rated to ICEA electrical withstand test for 1000 volts
- RUS accepted for use as jacket restoration materials on JCN cable

APPLICATIONS

- For use on standard poly- or elastomeric insulated/jacketed cables or lead-jacketed cables, which may include aluminum or steel armoring.
- Use as insulation for 1/C low-voltage power cable up to 1000 volts, jacket repair up to 35 kV, or general sealing applications.

BENEFITS

- ♦ CRSM sleeves close easily with a permanent locking system that consists of a raised rail profile and a stainless steel channel.
- ♦ Excellent water seal - tested in one foot head of water
- ♦ Conforms to Substrate
- ♦ Unlimited shelf life when stored in normal conditions

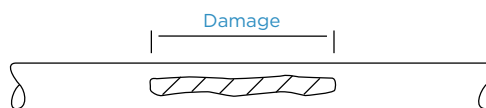

Cut sleeve length = Damage length + total seal length (see chart)

Damage Total	Total Seal Length
<3 (<76)	3 (76)
3-12 (76-305)	4 (102)
12-24 (305-610)	6 (152)
>24 (>610)	8 (203)

PRODUCT SELECTION INFORMATION: DIMENSIONS IN INCHES (MM)

Primary Electrical Repair					
Catalog Number	Sleeve Length	Primary Electrical Repair (1000 V) Cable and Jacket Repair Conductor Size Use Range		General Sealing Use Range (0 - 35 kV) (min - max)	Standard Pack
		(AWG/kcmil)	(min - max)		
CRSM 34/10-200	08 (200)	#8-2/0	0.25-0.60 (6-15)	0.25-1.20 (6-30)	3
CRSM 34/10-1200	48 (1200)	#8-2/0	0.25-0.60 (6-15)	0.25-1.20 (6-30)	5
CRSM 53/13-200	08 (200)	3/0-400	0.60-0.95 (15-24)	0.60-1.80 (15-46)	10
CRSM 53/13-1200	48 (1200)	3/0-400	0.60-0.95 (15-24)	0.60-1.80 (15-46)	5
CRSM 84/20-750	30 (750)	500-1000	0.95-1.40 (24-36)	0.95-2.70 (24-69)	10
CRSM 84/20-1200	48 (1200)	500-1000	0.95-1.40 (24-36)	0.95-2.70 (24-69)	5
CRSM 107/29-1000	40 (1000)	1000-2000	1.30-2.00 (33-51)	1.30-3.60 (33-91)	10
CRSM 107/29-1200	48 (1200)	1000-2000	1.30-2.00 (33-51)	1.30-3.60 (33-91)	5
CRSM 143/36-1200	48 (1200)			1.65-4.95 (42-126)	5
CRSM 198/55-1200	48 (1200)			2.50-6.50 (64-165)	5

ADDITIONAL PRODUCT INFORMATION

- Select the appropriate catalog number for either primary electrical repair (1000 volts max.) or general sealing applications. Electrical repair selections are based on typical dimensions for low-voltage insulated cable. Confirm selection with cable dimensions to assure proper sizing.
- Use the "Primary electrical repair" columns for electrical repair applications (when CRSM is in direct contact with the conductor).
- Use the "General sealing use range" column for general re-jacketing or sealing applications (when CRSM is not in direct contact with the conductor).
- Package does not contain connectors.
- Kits include a wraparound sleeve and stainless steel channel closure. Both can be field-cut for shorter requirements
- Related test report: EDR-5124, EDR-5192, and EDR-5388. UV resistant test report: EDR-5361.
- CRSM-34/10 and CRSM-84/20 are available in shorter standard lengths by ordering the corresponding CRSM-CT kits. (The use ranges in the selection information table still apply).

For connector information refer to the Connectors and Terminals section of this catalog.

CRSM CT Heat Shrink Wraparound Cable Tap Splices (1000 V)

FEATURES

- TE's Raychem CRSM CT Splices are qualified to ANSI C119.1 rated to ICEA electrical withstand test for 1000 volts
- RUS accepted for use with compression and split-bolt connectors
- Kit contains sealant strip and cloth tape for sealing tap connection.
- Sealant-coated

APPLICATIONS

- Wraparound, sealed cable tap splice on standard poly- or elastomeric insulated conductors (1000V)

BENEFITS

- CRSM sleeves close easily with a permanent locking system that consists of a raised rail profile and a stainless steel channel.
- Designed to match cable performance
- Conforms to substrate
- Unlimited shelf life when stored in normal conditions



PRODUCT SELECTION INFORMATION: DIMENSIONS IN INCHES (MM)

Catalog Number	Sleeve Length	Conductor Size (1000 V max.)		Connector Dimension (max D)	Std. Pack
		Main (AWG/kcmil)	Tap (AWG/kcmil)		
Compression connector					
CRSM-CT-34/10-150	6 (150)	#8-#2	#10-#2	2 (51)	10
CRSM-CT-53/13-200	8 (200)	#2-4/0	#10-4/0	4 (102)	10
CRSM-CT-84/20-250	10 (250)	4/0-500	#2-500	6 (152)	10
Standard split-bolt connector					
CRSM-CT-53/13-200	8 (200)	#8-#2	#14-#2	1.5 (38)	10

ADDITIONAL PRODUCT INFORMATION

- Select the appropriate catalog number based on the main and tap conductor sizes and connector type for electrical repair (1000 volts max.). Selections are based on typical dimensions for low-voltage insulated cable. Confirm selection with cable dimensions to assure proper sizing.
- Kits are capable of insulating and sealing wye (3-wire) or H (4-wire) configurations up to 1000 volts.
- Kits do not contain connectors.
- Standard package: 10 kits/box.
- Related test report: EDR-5192.
- UV resistant test report: EDR-5361.

Compression Connector

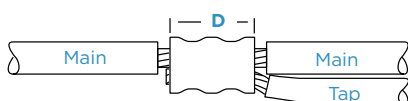

Split-Bolt Connector

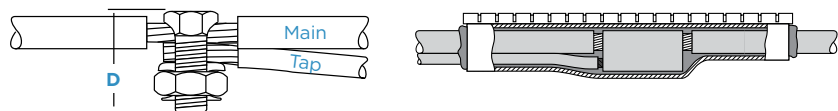

For connector information refer to the Connectors and Terminals section of this catalog.

MRS Heat-Shrink Wraparound Flame-Retardant Repair Sleeves (2 kV)

FEATURES

- Flame retardant
- MSHA approved (P-07-KA090012-MSHA)
- TE's Raychem MRS Repair Sleeve is precoated with adhesive.
- Green thermosensitive paint provides visual guide for proper installation.

APPLICATIONS

- Repair insulation on flexible cables to 2 kV and repairing jacket damage on high-voltage cable where a splice is not required.
- Ideal for use on trailing cable as well as flexible-construction cables and conduits

BENEFITS

- ♦ Installs with a low profile quickly and easily, which means the cable can be returned to service in minutes.
- ♦ Length may be field-cut for versatility
- ♦ Excellent water barrier - tested under one foot of water
- ♦ Unlimited shelf life when stored in normal conditions



Damage Total	Total Seal Length
<3 (<76)	3 (76)
3-12 (76-305)	4 (102)
12-24 (305-610)	6 (152)
>24 (>610)	8 (203)

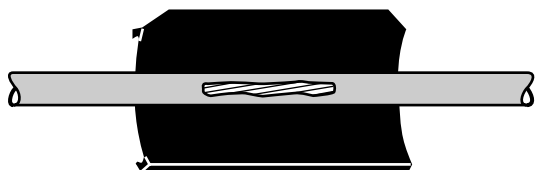

Cut sleeve length = Damage length + total seal length (see chart)

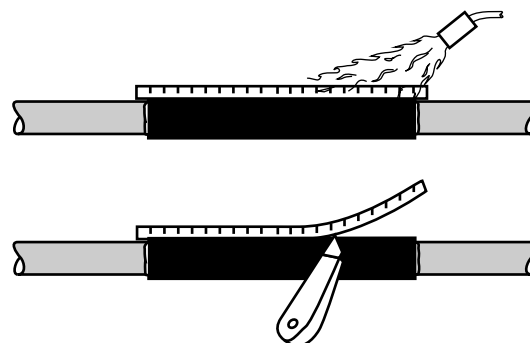

PRODUCT SELECTION INFORMATION: DIMENSIONS IN INCHES (MM)

Catalog Number	Cable Length (min - max)	Sleeve Length	Standard Pack (Kits/Box)
MRS-12-10	1.00-1.60 (25-41)	10 (254)	20
MRS-12-24	1.00-1.60 (25-41)	24 (610)	10
MRS-34-24	1.60-2.30 (41-58)	24 (610)	10
MRS-34-30	1.60-2.30 (41-58)	30 (762)	10
MRS-56-30	2.30-3.50 (58-89)	30 (762)	10

ADDITIONAL PRODUCT INFORMATION

- Select the appropriate catalog number based on cable diameter.
- Kits do not contain connectors.
- Kits contain a wraparound sleeve and stainless steel channel closure (removed after installation).
- Related test report: EDR-5028 and EDR-5499.

LV-MSK Heat Shrink Flexible Mining Cable Splice (600 V-2 kV)

FEATURES

- MSHA approved to P-137-4--MSHA

APPLICATIONS

- Flame-retardant, in-line and multi-conductor splice kits for use on mining cables and standard flexible cables up to 2 kV
- For types G, W, G-GC, and SHD-GC round and flat cables

BENEFITS

- Designed to Match Cable Performance
- Conforms to Substrate
- Unlimited shelf life when stored in normal conditions

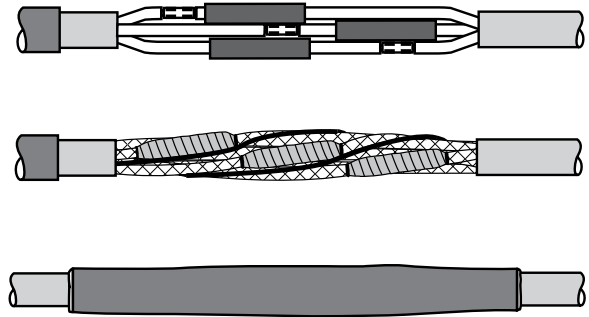

3

PRODUCT SELECTION INFORMATION: DIMENSIONS IN INCHES (MM)

Catalog Number	Cable Diameter (min - max)	Power Conductor Size (AWG/kcmil)			Standard Pack (Kits/Box)
		G or G - GC 3/C	W or G 2/C	W 4/C	
LV-MSK (600 V-2 kV) - Flat cables					
LV-MSK-046(B15)	0.85-1.40 (22-36)		#6-#2		15
LV-MSK-047	1.30-2.40 (33-61)	#6-#1	#1-4/0	#6-#1	10
LV-MSK-058	1.60-3.15 (41-80)	#2-4/0		#2-4/0	5
Round cables					
LV-MSK-045(B20)	0.85-1.40 (22-36)	#8-#6	#8-#6		20
LV-MSK-046(B15)	0.85-1.40 (22-36)	#6-#2	#6-#4		15
LV-MSK-047	1.30-2.40 (33-61)	#2-3/0	#3-3/0	#6-1/0	10
LV-MSK-058	1.60-3.15 (41-80)	2/0-500	2/0-350	1/0-350	5

ADDITIONAL PRODUCT INFORMATION

- Kits do not contain connectors; please order separately.
- LV-MSK-045 has a lower profile than LV-MSK-046.
- If 5-8 kV is required see HV-MSK.

For connector information refer to the Connectors and Terminals section of this catalog.

GelWrap Water Resistant Wraparound Splice Closures (1000 V)

FEATURES

- PowerGel silicone sealant in TE's Raychem GelWrap closure encapsulates the connection.
- Corrugated design enables greater range taking ability.
- Qualified to ANSI C119.1

APPLICATIONS

- Insulate and seal buried electrical connections rated up to 1000 volts.
- Jacket repair
- Engineered to handle the harsh environments of direct burial and manhole applications.

BENEFITS

- ♦ PowerGel conforms to substrate providing reliable seal against moisture ingress.
- ♦ Quick installation, snap closure
- ♦ No special tools required
- ♦ Excellent insulating properties
- ♦ Easy, clean re-entry into electrical connection
- ♦ Unlimited shelf life



Testing	Test Conditions
ANSI C119.1	600 V insulated underground
Chemical Resistance	Fluid immersion, 168 hours @ 23°C, 75% elongation retention minimum <ul style="list-style-type: none"> • 10W-40 motor oil • 10% hydrochloric acid • 15% sodium chloride • 20% sodium hydroxide • ETX 60280 antifreeze (1000 hours)
Accelerated Aging	1000 hours @ 135°C <ul style="list-style-type: none"> • 93% retention tensile strength • 82% retention elongation at break

PRODUCT SELECTION INFORMATION: DIMENSIONS IN INCHES (MM)

Catalog Number	Sleeve Length	Conductor Size	Max Connector Opening	Max General Use Diameter Range	Std. Pack
GelWrap-18/4-100	4.0 (100)	#12-4/0 (4-95)	1.0 (25)	0.15-0.70 (4-18)	6
GelWrap-18/4-150	6.0 (150)	#12-4/0 (4-95)	3.0 (75)	0.15-0.70 (4-18)	6
GelWrap-18/4-200	8.0 (200)	#12-4/0 (4-95)	5.0 (125)	0.15-0.70 (4-18)	6
GelWrap-18/4-250	10.0 (250)	#12-4/0 (4-95)	7.0 (175)	0.15-0.70 (4-18)	6
GelWrap-18/4-300	12.0 (300)	#12-4/0 (4-95)	9.0 (225)	0.15-0.70 (4-18)	6
GelWrap-33/10-150	6.0 (150)	#2-500 (35-240)	2.0 (50)	0.40-1.30 (10-33)	6
GelWrap-33/10-200	8.0 (200)	#2-500 (35-240)	4.0 (100)	0.40-1.30 (10-33)	6
GelWrap-33/10-250	10.0 (250)	#2-500 (35-240)	6.0 (150)	0.40-1.30 (10-33)	6
GelWrap-33/10-300	12.0 (300)	#2-500 (35-240)	8.0 (200)	0.40-1.30 (10-33)	12
GelWrap-33/10-350	14.0 (350)	#2-500 (35-240)	10.0 (250)	0.40-1.30 (10-33)	10
GelWrap-50/20-200	8.0 (200)	250-750	2.0 (50)	0.80-1.50 (20-38)	12
GelWrap-50/20-250	10.0 (250)	250-750	4.0 (100)	0.80-1.50 (20-38)	12
GelWrap-50/20-300	12.0 (300)	250-750	6.0 (150)	0.80-1.50 (20-38)	12
GelWrap-50/20-350	14.0 (350)	250-750	8.0 (200)	0.80-1.50 (20-38)	12
GelWrap-50/20-400	16.0 (400)	250-750	10.0 (250)	0.80-1.50 (20-38)	12
GelWrap-UF-200	8.0 (200)	14/2-8/3 w/ground	N/A	N/A	10

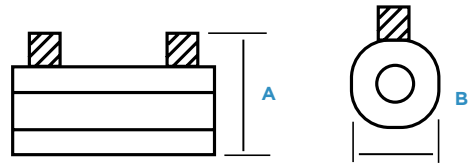
**PRODUCT SELECTION INFORMATION: DIMENSIONS IN INCHES (MM)**

Catalog Number	Sleeve Length	1000V Cable Range	Max Connector Opening	Max Compression Connector Dia.	Max Mechanical Connector Dimensions	
					Height* (A)	Width (B)
GelWrap-18/4-150UL	6.0 (150)	#14-4/0 AWG	2.0 (50)	0.85 (22)	1.2 (30)	1.1 (28)
GelWrap-18/4-200UL	8.0 (200)	#14-4/0 AWG	4.0 (100)	0.85 (22)	1.2 (30)	1.1 (28)
GelWrap-18/4-250UL	10.0 (250)	#14-4/0 AWG	6.0 (150)	0.85 (22)	1.2 (30)	1.1 (28)
GelWrap-18/4-300UL	12.0 (300)	#14-4/0 AWG	8.0 (200)	0.85 (22)	1.2 (30)	1.1 (28)
GelWrap-18/4-350UL	14.0 (350)	#14-4/0 AWG	10.0 (250)	0.85 (22)	1.2 (30)	1.1 (28)
GelWrap-18/4-400UL	16.0 (400)	#14-4/0 AWG	12.0 (300)	0.85 (22)	1.2 (30)	1.1 (28)
GelWrap-18/4-450UL	18.0 (450)	#14-4/0 AWG	14.0 (350)	0.85 (22)	1.2 (30)	1.1 (28)
GelWrap-18/4-500UL	20.0 (500)	#14-4/0 AWG	16.0 (400)	0.85 (22)	1.2 (30)	1.1 (28)
GelWrap-18/4-550UL	22.0 (550)	#14-4/0 AWG	18.0 (450)	0.85 (22)	1.2 (30)	1.1 (28)
GelWrap-18/4-600UL	24.0 (600)	#14-4/0 AWG	20.0 (500)	0.85 (22)	1.2 (30)	1.1 (28)
GelWrap-UF-250UL	10.0 (250)	14/2-8/3 w/ground	N/A	N/A	N/A	

*Height includes screws with cable installed.

Notes: UL denotes UL & cUL for submersible applications. For other sizes or applications, a minimum seal length is required on each side of connector opening or jacket damage: GelWrap closure 18/4 series 1.5 (38), GelWrap closure 33/10 series 2.0 (51), GelWrap closure 50/20 series 3.0 (75).

ADDITIONAL PRODUCT INFORMATION

- Selection is based on typical dimensions for low-voltage insulated cables.
- Related test reports: EDR-5343-18/4, EDR-5356-33/10, EDR-5367 for 50/20, EDR-5356 for GelWrap-33/10-250-I350M4 (A four screw connector is included). EDR-5356-GelWrap-UF)

For connector information refer to the Connectors and Terminals section of this catalog.

Rayvolve RVS “Roll-on” Splices for 1/C Power Cable (1000 V)

FEATURES

- Qualified to ANSI C119.1. CSA certified to C22.2 No. 198.2. UL listed per 96J4 (file E91151). RUS accepted for use as a secondary tap or splice cover.
- TE's Raychem RVS splice cover sleeves feature a dual-wall design with an entrapped lubricant, making installation fast and simple. The elastomeric sleeve rolls onto the cable with minimal effort, even at temperatures below -15°F (-25°C).

APPLICATIONS

- For use on standard poly- or elastomeric-insulated cables. Use to insulate and seal in-line compression connectors or to seal terminal lugs.
- Specially formulated EPDM elastomer combines with the high-performance sealant to form a water-resistant, insulating sleeve that is UL listed and CSA certified for direct burial application over in-line compression connectors.

BENEFITS

- ♦ Easy “roll-on” installation to effectively insulate and seal cable connections up to 1000 V.
- ♦ Ideal for use where gas or electric heating devices are not approved.



PRODUCT SELECTION INFORMATION: DIMENSIONS IN INCHES (MM)

Catalog Number	Conductor Size (AWG/kcmil)	Cable OD (min - max)	Sleeve Length	Max Connector Length
RVS-11	#8-2/0	.22-.68 (6-17)	8.0 (205)	5.00 (127)
RVS-12	1/0-250	.50-.90 (13-23)	9.5 (241)	4.50 (114)
RVS-13	250-600	.70-1.20 (18-30)	12.0 (305)	7.00 (178)
RVS-14	600-1000	.95-1.50 (24-38)	14.0 (356)	9.00 (229)

ADDITIONAL PRODUCT INFORMATION

- Select the appropriate catalog number. Selections are based on typical dimensions of low-voltage insulated cable. Confirm selection with dimensions to assure proper sizing.
- Kits do not contain connectors. The RVS splice cover selection information mentioned above covers copper and aluminum in-line compression connections.
- Each kit contains one Rayvolve RVS splice cover sleeve and sealant strips
- Standard package: 5 kits/box or 50 kits/box.
- Related test report: EDR-5167.

GILS Gel In-Line Water Resistant Splice Kit for Power Cable (1000 V)

FEATURES

- Connector accommodates copper and/or aluminum cables
- Qualified to ANSI C119 for underground splicing
- UV resistant
- Qualified for temperatures from -40°C to 90°C
- Connector included
- RUS accepted connector blocks and splices for secondary.
- Water-tight for use in all locations

APPLICATIONS

- TE's Raychem GILS gel in-line splice kits, offer a state-of-the-art sealed splice for underground, buried, and overhead applications. GILS closures offer a fast and simple method for splicing, insulating, and environmentally sealing low-voltage cable splices.

BENEFITS

- ♦ TE's Raychem PowerGel conforms to substrate providing reliable seal against moisture ingress.
- ♦ Quick installation, snap closure
- ♦ No special tools required
- ♦ Excellent insulating properties
- ♦ Easy, clean re-entry into electrical connection
- ♦ Unlimited shelf life



PRODUCT SELECTION INFORMATION: DIMENSIONS IN INCHES (MM)

Catalog Number	Conductor Size (AWG/kcmil)	Std. Pack
GILS-4/0	#2-4/0	18 or 72 each
GILS-350	1/0-350	18

ADDITIONAL PRODUCT INFORMATION

- Based on typical dimensions for low-voltage insulated cables.
- Related test reports: EDR-5298, EDR-5394

GHFC Water Resistant H-Frame Closure for Power Cable (1000 V)

FEATURES

- Molded cover of UV stable, impact-resistant polypropylene provides rugged protection for underground or overhead applications.
- Gel conforms to substrate to effectively seal out moisture and contaminants
- Qualified to ANSI C119.1
- Qualified for temperatures from -40°C to 90°C.

APPLICATIONS

- Fast, simple method for insulating and environmentally sealing low-voltage cable-taps and splices made with H-frame compression connectors. Common applications are street light connections and overhead transformer leads.

BENEFITS

- ♦ TE's Raychem PowerGel conforms to substrate providing reliable seal against moisture ingress.
- ♦ Quick installation, snap closure
- ♦ No special tools required
- ♦ Excellent insulating properties
- ♦ Easy, clean re-entry into electrical connection
- ♦ Unlimited shelf life when stored in normal conditions



ADDITIONAL PRODUCT INFORMATION

- Select the appropriate catalog number. Selections are based on typical dimensions for low-voltage, insulated cables and connectors.
- Approved connectors (supplied by others) include, but are not limited to:

Product	Approved Connectors
GHFC-1-90	Homac UB214; T&B 63105; Blackburn WR9; Burndy YPC2A8U
GHFC-2-90	Homac OB22, OB44, OB102, OB103; Burndy YHO-1, YHO-2, YHO100, YHO125, YHO150; Blackburn WR139, WR159, WR179, WR199; ILSCO AH1; T&B 63110; UTILCO HT1, HT2

- Standard packs of 100 ea. are also available. Substitute a (B100) in place of the (B10) in the catalog number.
- Related test report: GHFC-1-90 and GHFC-2-90, EDR-5264, GHFC-3-90, EDR-5326.

PRODUCT SELECTION INFORMATION: DIMENSIONS IN INCHES (MM)

Catalog Number	Conductor Size		Die	Box Dimensions			Std Pack
	Main	Std. Tap		Length	Width	Height	
GHFC-1-90	#6-#2	#14-#8	BG	2.75 (70)	1.625 (41)	1.0625 (27)	10 or 100
GHFC-2-90	#2-2/0	#14-#6	O	4.25 (108)	2.0 (51)	1.1875 (30)	10 or 100
GHFC-2.5-90	1/0-4/0	#6-3/0	D	7.032 (179)	2.75 (70)	1.560 (40)	30 each
GHFC-3-90	350	4/0	D	6.25 (159)	3.250 (83)	1.90 (49)	6 or 18

Molded cover of UV stable, impact resistant polypropylene provides rugged protection for underground or overhead applications.

Fragible fingers provide wide cable range.

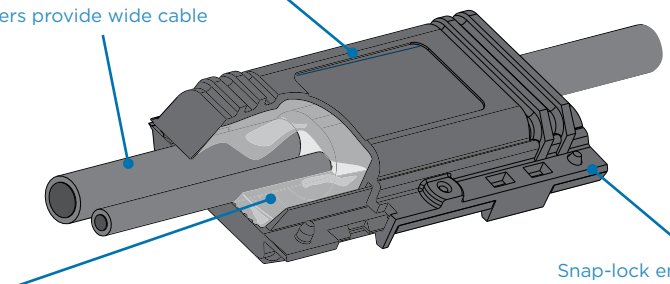

Snap-lock ensures that cover remains closed.

Silicone gel is high dielectric insulation and provides constant pressure on cable and connector to provide waterseal. PowerGel sealant is specifically formulated for high temperature environments.

GTAP Water Resistant Splice (1000 V)

FEATURES

- Molded cover of UV stable, impact-resistant polypropylene provides rugged protection for underground or overhead applications.
- TE's Raychem gel conforms to substrate to effectively seal out moisture and contaminants
- Four port (2-in, 2-out design), range-taking mechanical connectors splice a wide range of copper and aluminum cables

APPLICATIONS

- Connect, insulate, and seal low-voltage splices (1000V)
- Commonly used in street lighting applications.

BENEFITS

- ♦ PowerGel conforms to substrate providing reliable seal against moisture ingress.
- ♦ Quick installation, snap closure
- ♦ No special tools required
- ♦ Excellent insulating properties
- ♦ Easy, clean re-entry into electrical connection
- ♦ Unlimited shelf life when stored in normal conditions



SELECTION INFORMATION: DIMENSIONS IN INCHES (MM)

Catalog Number	Conductor Size (All Outlets) AWG (mm ²)	Length	Width	Height	Standard Pack
GTAP-1	#14-#2 (2-35)	2.75 (70)	1.625 (41)	1.0625 (27)	18 or 72
GTAP-2	#14-2/0 (2-70)	4.25 (108)	2 (51)	1.1875 (30)	18 or 72

ADDITIONAL PRODUCT INFORMATION

- Selection based on typical dimensions of low-voltage insulated cables.

Molded cover of UV stable, impact resistant polypropylene provides rugged protection for underground or overhead applications.

Range-taking mechanical connector made of aluminum. Accepts both copper and aluminum conductors.

Frangible fingers provide wide cable range.

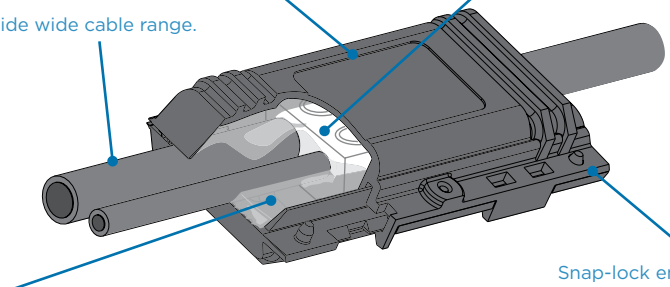

Snap-lock ensures that cover remains closed.

Silicone gel is high dielectric insulation and provides constant pressure on cable and connector to provide waterseal. PowerGel sealant is specifically formulated for high temperature environments.

Gelport Submersible Connectors for URD Distribution (1000 V)

FEATURES

- TE's Raychem GelPort is qualified to ANSI C119.1
- Gel-filled cable entry ports provide a reliable cable seal
- PowerGel sealing gel seals out harsh environments
- Rugged, impact-resistant housing stands up to rough installations
- Clear view back allows for easy positive visual indication of wire position in connector

APPLICATIONS

- Multi-port secondary connectors for low voltage submersible (hand hole / man hole) applications

BENEFITS

- TE's Raychem PowerGel conforms to substrate providing reliable seal against moisture ingress.
- Quick and easy installation
- Clean re-entry into electrical connection
- Unlimited shelf life when stored in normal conditions
- No loose parts due to one piece housing



Testing	Approved Connectors
Complete unit	ANSI C119.1, Report: EDR-5379, EDR-5409, EDR-5427, EDR 5463
Connector	ANSI C119.4, Report: 502-47264, 502-47302, 502-47308
Chemical Resistance	ASTM D543 to the following liquids: Sulfuric Acid, Sodium Sulfate, Sodium Chloride, Sodium Hydroxide, Ethylene Glycol
UV Resistance	ASTM G-53-95, ASTM-D-638-95

PRODUCT SELECTION INFORMATION: DIMENSIONS IN INCHES (MM)

Catalog Number*	Number of Wire Ports	Conductor Use Range (mm2)	Length	Width	Height	Std. Pack
GelPort 350/500						
GPRT-350-3P(B6)	3	14-350 (2-150)	4.60 (117)	3.825 (97)	3.50 (89)	6
GPRT-350-4P(B6)	4	14-350 (2-150)	5.85 (149)	3.825 (97)	3.50 (89)	6
GPRT-350-5P(B6)	5	14-350 (2-150)	7.10 (180)	3.825 (97)	3.50 (89)	6
GPRT-350-6P(B6)	6	14-350 (2-150)	8.35 (212)	3.825 (97)	3.50 (89)	6
GPRT-350-8P(B6)	8	14-350 (2-150)	10.85 (276)	3.825 (97)	3.50 (89)	6
GPRT-350/4P-500/1P (B6)	5 Hybrid		7.10 (180)	3.825 (97)	3.50 (89)	6
	4	14-350 (2-150)				
	1	6-500 (16-250)				
GPRT-350/6P-500/2P (B6)	8 Hybrid		10.85 (276)	3.825 (97)	3.50 (89)	6
	6	14-350 (2-150)				
	2	6-500 (16-250)				

Catalog Number*	Clear View	Number of Wire Ports	Max Cable OD	Max Number 500 kcmil Cables	Length	Width	Height
GelPort 500							
GPRT-500-3P(B6)	C	3	0.96	1 (#6-500 kcmil)	4.6 (117)	3.825 (97)	3.50 (89)
GPRT-500-4P(B6)	C	4	0.96	2 (#6-500 kcmil)	5.85 (149)	3.825 (97)	3.50 (89)
GPRT-500-5P(B6)	C	5	0.96	3 (#6-500 kcmil)	7.1 (180)	3.825 (97)	3.50 (89)
GPRT-500-6P(B6)	C	6	0.96	4 (#6-500 kcmil)	8.35 (212)	3.825 (97)	3.50 (89)
GPRT-500-8P(B6)	C	8	0.96	6 (#6-500 kcmil)	10.85 (276)	3.825 (97)	3.50 (89)

*For Clear view back housing, add "-C" to end of catalog number. Standard housing is black.

ADDITIONAL PRODUCT INFORMATION

- Selection based on typical dimensions of low voltage cables.
- Standard package is 6/box.

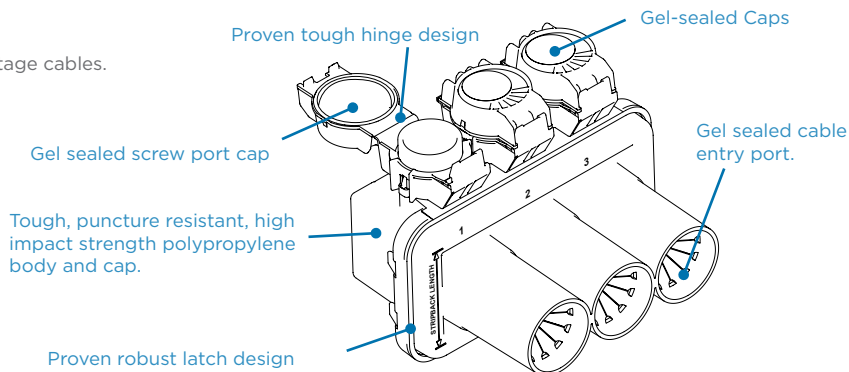

GelCap SL Water Resistant Splice Covers for Street Lights (1000V)

FEATURES

- Three wire connector is perfect for street light connections - two ports accept #14-2/0 AWG for the feeder cables and a single port for a #14-6 AWG wire to power the light.
- Temperature range - 40°C to 105°C

APPLICATIONS

- TE's Raychem GelCap SL Insulates, seals, and protects street lighting connections.
- Other applications include irrigation systems, HVAC, and motor connections.

BENEFITS

- ♦ TE's Raychem PowerGel conforms to substrate providing reliable seal against moisture ingress.
- ♦ Quick installation, snap closure
- ♦ No special tools required
- ♦ Excellent insulating properties
- ♦ Easy, clean re-entry into electrical connection
- ♦ Unlimited shelf life when stored in normal conditions



Testing	Test Conditions
Chemical Resistance	ASTM D543, Sulfuric acid, Sodium Hydroxide and motor oil
Ozone Resistance	ASTM D1149, 168 hours @ 40°C, 50 ppm
Accelerated Aging	ASTM D2671
Abrasion Resistance	2040 gm wt., 4000 cycles, 2% max thickness loss

3

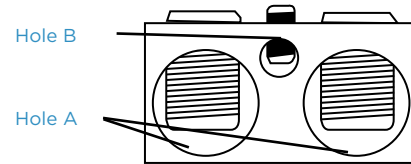

SELECTION INFORMATION: DIMENSIONS IN INCHES (MM)

Catalog Number	Hole A		Hole B		Standard Pack
	Wire Range	Recommended Torque Values	Wire Range	Recommended Torque Values	
GelCap-SL-2/0-3HOLE(B10)	#14-2/0 AWG	120-180 in-lbs	#14-6 AWG	120-150 in-lbs	10
GelCap-SL-2/0-3HOLE-B100	#14-2/0 AWG	120-180 in-lbs	#14-6 AWG	120-150 in-lbs	100

ADDITIONAL PRODUCT INFORMATION

- Selections are based on typical dimensions of low-voltage insulated cables.
- Kits include UL Listed connectors for use with copper and/or aluminum conductors.
- Each kit contains a gel filled cap, cap clamp, and connector.
- Related test reports: EDR-5334, EDR-5352, EDR-5488, EDR-5520.
- Qualified to ANSI C 119.1 per EDR-5520.



GelCap Water Resistant Stub Splice Covers (1000 V)

FEATURES

- TE's Raychem GelCap gel conforms to substrate to effectively seal out moisture and contaminants
- Corrugated cover design increases range-taking ability
- UL Listed for US and Canada (CUL) 105°C

APPLICATIONS

- Insulate, seal, and protect stub splice connections up to 1000 volts. Common applications include motor connections, street lights, HVAC, landscape lighting, and irrigation systems.

BENEFITS

- TE's Raychem PowerGel conforms to substrate providing reliable seal against moisture ingress.
- Quick installation, snap closure
- No special tools required
- Excellent insulating properties
- Easy, clean re-entry into electrical connection



Testing	Test Conditions
Chemical Resistance	ASTM D543, Sulfuric acid, Sodium hydroxide and motor oil
Ozone Resistance	ASTM D1149, 168 hours @40°C, 50pphm
Accelerated Aging	ASTM D2671
Abrasion Resistance	2040 gm wt., 4000 cycles, 2% max thickness loss

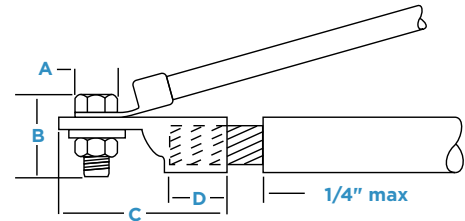

SELECTION INFORMATION: DIMENSIONS IN INCHES (MM)

Max Bolt Dimensions							
Catalog Number	Feeder Conductor Size (mm)	Width (A)	Length (B)	Max Lug Dimensions Total Length (C)	Barrel Length (D)	Cap Length (Nominal)	Standard Pack
GelCap 1(B5)*	#16-#10 AWG (1.5-5)	.375 (10)	.500 (13)	1.00 (25)	0.5 (13)	2.8 (71)	5
GelCap 2(B5)	#8-#2 AWG (8-35)	.625 (16)	1.00 (25)	2.00 (51)	1.0 (25)	3.5 (89)	5
GelCap 3(B5)	#2-#4/0 AWG (35-105)	.850 (22)	1.30 (33)	3.00 (76)	1.5 (38)	6.0 (152)	5
GelCap 4(B5)	250-500 kcmil (125-250)	1.100 (28)	1.85 (47)	5.00 (127)	2.0 (51)	8.0 (203)	5

* For wire sizes #16 - #10, the unique design of the GelCap 1 splice kit saves space by allowing all three phase connections to be installed in one cover. Note: GelCap 1 kit contains one GelCap cover only. For GelCap splice kits sizes 2-4, one cap per phase is provided.

ADDITIONAL PRODUCT INFORMATION

- Selection based on typical dimensions of low-voltage insulated cables.
- Kits do not contain connectors.
- Related test report: EDR-5435.

Silicone gel is high dielectric insulation and provides constant pressure on cable and connector to provide waterseal. PowerGel sealant is specifically formulated for high temperature environments.

Snap-lock feature provides quick installation removal.

Molded cover is abrasion and impact resistant. Elastomer provides rugged protection for electrical connection.

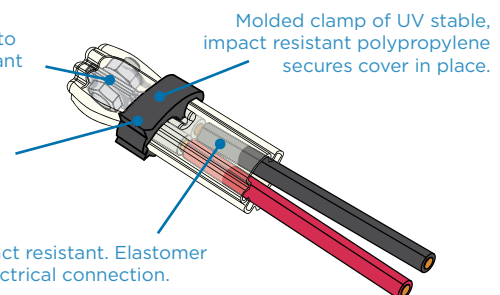

MCK Heat Shrink Motor Connection Kits for 1/C (2000 V)*

FEATURES

- TE's Raychem MCK motor connection is qualified to ANSI C119.1 and ICEA
- Available in two types:
 - Type V kit for stub / butt splice, #14-500kcmil
 - Type L kit for In-line splice, #8-1000kcmil

APPLICATIONS

- Application: in-line or stub splice between 1/C feeder cable and motor leads

BENEFITS

- Excellent insulation sealing and resistance to abrasion in motor connections



Type V
Stub configuration

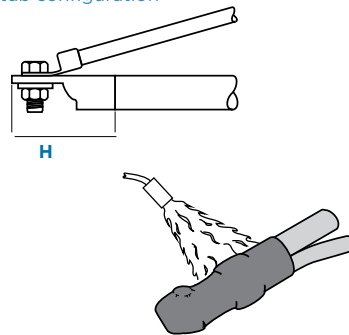

Type L
In-line configuration

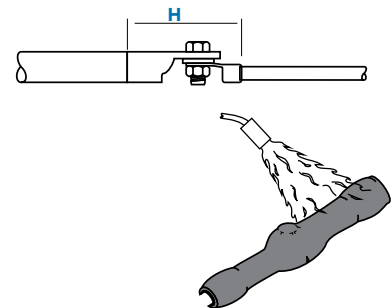

SELECTION INFORMATION: DIMENSIONS IN INCHES (MM)

Catalog Number	Motor Feeder Size (AWG/kcmil)	Bolt Length (max)	Connection Length (max) H	Length (Nominal)	Standard Pack
Stub Type V				Cap	
MCK-1V	#14-#10	0.625	2.0 (51)	2.5 (64)	5
MCK-2V	#12-#4	0.75	2.5 (64)	3.4 (86)	5
MCK-3V	#2-4/0	1	3.5 (89)	4.5 (114)	5
MCK-4V	250-500	1.5	4.5 (114)	6.5 (165)	5
In-Line Type L				Sleeve	
MCK-1L	#8-4/0	1.25	5.0 (127)	9.0 (229)	5 for 1l and 2l
MCK-2L	250-1000	1.25	8.0 (203)	12.0 (305)	

Note: Product Rating:
600 V rating - phase to ground per ANSI C119.1
1000 V rating - phase to phase per ANSI C119.1
2000 V rating - EDR 5110; ICEA S-66-524 (2kV class) AC and DC voltage withstand

ADDITIONAL PRODUCT INFORMATION

- Select appropriate catalog number based on the motor feeder cable. MCK selections are based on the typical dimensions of 100% insulated cables manufactured in accordance with AEIC CS5 and AEIC CS6, as well as the dimensions connectors. Nominal insulation thickness (100%): 90 mils. For cables manufactured to other specifications, confirm selection with cable and connector dimensions.
- MCK kits are designed for single-hole connectors and include caps and sealant strips for three connections. Kits do not contain connectors.
- Related test report: MCK: EDR-5110.

For connector information refer to the Connectors and Terminals section of this catalog.

Rayvolve RVC “Roll-on” Stub Connection Splice Cover Kits (1000 V)

FEATURES

- Elastomeric RVC cap splice cover provides the required insulation thickness, withstands abrasion, and forms a water-resistant seal
- Qualified to ANSI C-119.1

APPLICATIONS

- Insulate and seal 1kV stub connections (motor leads and street lights)

BENEFITS

- ♦ Fast and easy roll-on installation - Install all 3 phases at the same time
- ♦ Tool-free and compact size makes TE's Raychem RVC cap ideal for installation in cramped motor boxes



PRODUCT SELECTION INFORMATION: DIMENSIONS IN INCHES (MM)

Catalog Number	Conductor Size (AWG/kcmil)	Insulation Cut-Back (max)
Three-wire stub splices		
RVC-1V	#14-#8	1.75 (44)
RVC-2V	#6-#2	2.75 (70)

Catalog Number	Feeder Size (AWG/kcmil)	Bolt Dimensions		Lug Length (max)	Cap Length (Nominal)	Standard Pack
		Size (max)	Length (max)			
Motor Connections or two-wire stub splices						
RVC-1V(B5)	#14-#4	.375 (8)	.625 (15)	1.75 (45)	3.00 (75)	5
RVC-2V(B5)	#8-2/0	.375 (8)	.750 (20)	2.75 (70)	4.00 (100)	5
RVC-3V(B5)	#2-4/0	.500 (12)	1.00 (25)	3.00 (75)	5.25 (130)	5
RVC-4V(B5)	250-500	.625 (16)	1.50 (35)	5.00 (125)	7.50 (190)	5

ADDITIONAL PRODUCT INFORMATION

- Select the appropriate catalog number. Selections are based on typical dimensions of low-voltage insulated cable. Confirm selection with dimensions to assure proper sizing.
- Each kit contains one Rayvolve RVC splice cover sleeve and sealant strips.
- Standard package: 5 kits/box.
- Related test report: EDR-5614.
- For connector information refer to the Connectors and Terminals section of this catalog.

Smart Limiter and Crab Joints Cable Protection

FEATURES

- 100% submersible
- Sealing and mechanical protection are built in, eliminating the need for additional components
- Gel-filled cable entries will quench an arc when "live" connections are made
- Hinged bolt caps allow re-entry, enabling voltage measurements to be taken
- Modular design allows circuits to be added or subtracted without cutting cables
- No parts to move, slide or park when installing or removing the limiter
- Tested fault duty of 25 kA per limiter
- Designed specifically for 208Y/120V systems

APPLICATIONS

- Protects underground secondary cable from damage by short-circuit fault currents
- Designed for specific cable size (4/0, 250kcmil, 350kcmil, 500kcmil, 750kcmil)
- Installed in-line on individual cables or ganged together in a "crab joint".
- 100% submersible copper buses (crab joints) are also available, making installation of TE's Smart Limiter system compact, convenient and reliable. Available in 3-Way, 5-Way and 7-Way configurations

BENEFITS

- ♦ Increases reliability by protecting cable system from damage
- ♦ Clear housing provides quick visual identification of blown limiters reducing the time to find faulted limiters
- ♦ Fast and easily repeatable installation regardless of installer experience
- ♦ High-temperature clear inner and outer shells help in dissipating heat



PRODUCT SELECTION INFORMATION

Catalog Number	Description	Per Box
Smart Limiter		
SL-4/0-120V-NF-FT (B1)	Non-Fused splice for 4/0 cable	1
SL-4/0-120V-F-01 (B1)	Fused limiter for 4/0 cable	1
SL-250-120V-NF-FT (B1)	Non-Fused splice for 250 kcmil cable	1
SL-250-120V-F-01 (B1)	Fused limiter for 250 kcmil cable	1
SL-350-120V-NF-FT (B1)	Non-Fused splice for 350 kcmil cable	1
SL-350-120V-F-01 (B1)	Fused limiter for 350 kcmil cable	1
SL-500-120V-NF-FT (B1)	Non-Fused splice for 500 kcmil cable	1
SL-500-120V-F-01 (B1)	Fused limiter for 500 kcmil cable	1
SL-750-120V-NF-FT (B1)	Non-Fused splice for 750 kcmil cable	1
SL-750-120V-F-01 (B1)	Fused limiter for 750 kcmil cable	1
Copper Crab Joints		
CJ-4/0-3W3W-CU-FT-B1	3 way/3 way joint with 4/0 conductors	1
CJ-4/0-5W5W-CU-FT-B1	5 way/5 way joint with 4/0 conductors	1
CJ-4/0-7W7W-CU-FT-B1	7 way/7 way joint with 4/0 conductors	1
CJ-250-3W3W-CU-FT-B1	3 way/3 way joint with 250 kcmil conductors	1
CJ-250-5W5W-CU-FT-B1	5 way/5 way joint with 250 kcmil conductors	1
CJ-250-7W7W-CU-FT-B1	7 way/7 way joint with 250 kcmil conductors	1
CJ-350-3W3W-CU-FT-B1	3 way/3 way joint with 350 kcmil conductors	1
CJ-350-5W5W-CU-FT-B1	5 way/5 way joint with 350 kcmil conductors	1
CJ-350-7W7W-CU-FT-B1	7 way/7 way joint with 350 kcmil conductors	1
CJ-500-3W3W-CU-FT-B1	3 way/3 way joint with 500 Kcmil conductors	1
CJ-500-5W5W-CU-FT-B1	5 way/5 way joint with 500 kcmil conductors	1
CJ-500-7W7W-CU-FT-B1	7 way/7 way joint with 500 kcmil conductors	1
CJ-750-3W3W-CU-FT-B1	3 way/3 way joint with 750 kcmil conductors	1
CJ-750-5W5W-CU-FT-B1	5 way/5 way joint with 750 kcmil conductors	1
CJ-750-7W7W-CU-FT-B1	7 way/7 way joint with 750 kcmil conductors	1

RELATED TEST REPORTS:

EDR-5445, EDR-5446, EDR-5450,
EDR-5452, 502-47332, 502-47339,
502-47348.





Chapter 4 TE's Raychem Medium Voltage Cable Accessories

In-Line Splice	
Heat Shrink	134
Cold Applied	158
Terminations	
Heat Shrink.....	168
Cold Applied.....	178
Motor Connection Kits & Stub Splices.....	187
Elbows & Accessories	189



HVS-500/HVSA-500 Splices for 1/C & 3/C Inline Cable, Including Armored

FEATURES

- TE's Raychem HVS/HVSA-500 splices are rated to meet the applicable portions of IEEE 404

APPLICATIONS

- Non-shielded cable splices provide high abrasion-resistance and a positive environmental seal

BENEFITS

- Kits accommodate both jacketed and unjacketed cable

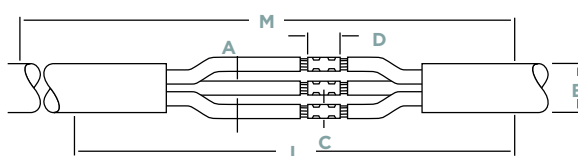
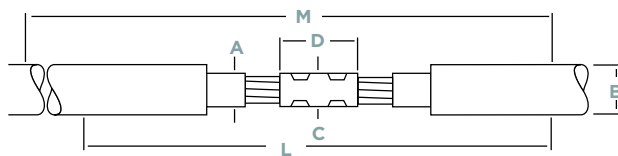

PRODUCT SELECTION INFORMATION: DIMENSIONS IN INCHES (MM)

Catalog Number	Conductor Size (AWG/kcmil)	Min - Max Insulator Dia. (A)	Jacket O.D. (max) (B)	Max Connector O.D. (C)	Max Connector Length (D)	Kit Installed Length (L)	Required Install Space (M)
1/C Non-Shielded Power Cable							
HVS-501	#6-#1	0.40-0.70 (10-18)	0.80 (20)	0.65 (17)	3.0 (76)	10 (254)	22 (559)
HVS-502	1/0-300	0.65-1.05 (17-27)	1.20 (30)	1.00 (25)	4.0 (102)	11 (279)	24 (610)
HVS-503	350-1000	0.95-1.65 (24-42)	1.84 (47)	1.85 (47)	6.0 (152)	15 (381)	30 (762)
HVS-3-500 3/C Non-Shielded Power Cable - No Armor							
HVS-3-501	#6-#1	0.40-0.70 (10-18)	3.00 (76)	0.65 (17)	3.0 (76)	32 (812)	40 (1016)
HVS-3-502	1/0-300	0.65-1.05 (17-27)	3.00 (76)	1.00 (25)	4.0 (102)	40 (1016)	48 (1219)
HVS-3-503	350-1000	0.95-1.65 (24-42)	3.95 (100)	1.85 (47)	6.0 (152)	48 (1219)	56 (1422)
HVSA-3-500 3/C Non-Shielded Power Cable - Armor							
HVSA-3-501	#6-#1	0.40-0.70 (10-18)	3.00 (76)	0.65 (17)	3.0 (76)	40 (1016)	48 (1219)
HVSA-3-502	1/0-300	0.65-1.05 (17-27)	3.00 (76)	1.00 (25)	4.0 (102)	40 (1016)	48 (1219)
HVSA-3-503	350-1000	0.95-1.65 (24-42)	3.95 (100)	1.85 (47)	6.0 (152)	52 (1321)	60 (1524)

ADDITIONAL PRODUCT INFORMATION

- Select the appropriate catalog number. Selections are based on 100%-insulated cables, manufactured in accordance with IEEE S-66-524 standard and commonly used connectors. Nominal insulation thickness (100%): 110 mils.
- For cables manufactured to other specifications, confirm selection with cable and connector dimensions.
- HVS-SHIM kits are available if the diameter of one of your cables is not within the standard range.
- Kits do not contain connectors; order compression or solder connectors separately.
- Standard package: HVS-500: Three 1/C kits/box, HVS-3-500: One 3/C kit/box, HVSA-3-500: One 3/C kit/box
- For an off-the-shelf 3/C splice alternative, select three appropriate 5 kV single-conductor kits from above and one HVS-3/C accessory kit (unarmored) or one HVSA accessory kit (armored cables)
- For Diesel Locomotive cables (DLO), please ask a TE customer service representative about the HVS-50x-TRACT series.
- Related test report: EDR-5096
- Verify insulation diameter since 5 kV non-shielded and TECK cable diameters are NOT STANDARD

HVS-J In-Line Splice for 1/C Jacketed Concentric Neutral Cables

FEATURES

- In addition to the unique internal moisture seal, the SJ/EJ kits feature TE's Raychem MBSM wraparound outer jacket which provides mechanical resistance to abrasion and impact, as well as an external moisture seal.
- TE's Raychem HVS joints have been qualified to IEEE-404

APPLICATIONS

- For 1/C jacketed concentric neutral cables up to 15 kV.

BENEFITS

- ♦ Provide stress control, rebuild the shielding systems, and restore primary cable insulation to 133% of the cable's original insulation level.
- ♦ High recovery forces
- ♦ Same range as prior HVS-1510S-J
- ♦ Range taking Aluminum or Copper shear bolts available

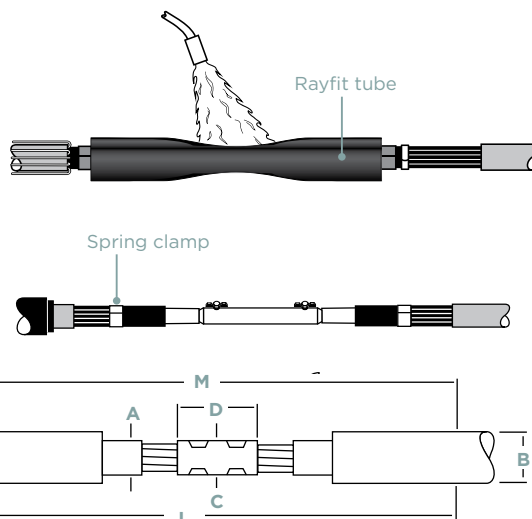
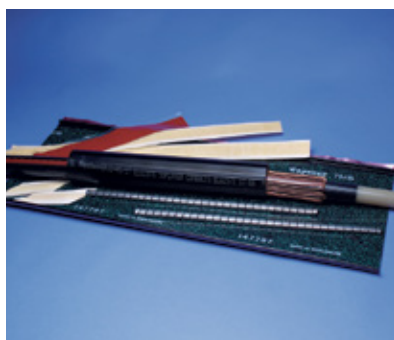

PRODUCT SELECTION INFORMATION: DIMENSIONS IN INCHES (MM)

Catalog Number	Conductor Size (AWG/kcmil)	Min - Max Insulation Dia. (A)	Jacket O.D. (max) (B)	Max Connector O.D. (C)	Max Connector Length (D)	Kit Installed Length (L)	Required Install Space (M)
HVS-C-1510S-J Without Connector							
HVS-C-1511S-J	#2-2/0	0.65-0.95 (17-24)	1.20 (30)	0.80 (20)	4.0 (100)	28 (700)	28 (700)
HVS-C-1512S-J	3/0-400	0.85-1.30 (23-33)	1.65 (42)	1.20 (30)	5.0 (125)	28 (700)	28 (700)
HVS-C-1513S-J	500-750	1.10-1.55 (28-47)	1.90 (48)	1.45 (44)	6.0 (150)	35 (870)	35 (870)
HVS-C-1514S-J	750-1000	1.30-1.90 (33-48)	2.30 (58)	1.85 (47)	8.0 (200)	35 (870)	35 (870)
HVS-C-1510S-J with Copper Mechanical Shear Bolt Connector							
HVS-C-1512S-J-M1	3/0-400	0.85-1.30 (23-33)	1.65 (42)	1.20 (30)	4.0 (100)	28 (700)	28 (700)
HVS-C-1513S-J-M2	500-750	1.10-1.55 (28-47)	1.90 (48)	1.45 (37)	5.0 (125)	35 (870)	35 (870)
<i>M1 = csbs-20C-500C-SOS. M2 = CSBS - 300C-750C-SOS</i>							
HVS-S-1510S-J-with Aluminum Mechanical Shear Bolt Connector							
HVS-S-1512S-J-M4	#2-2/0	0.65-0.95 (17-24)	1.20 (30)	.095 (24)	2.5 (65)	28 (700)	28 (700)
HVS-S-1512S-J-M5	2/0-350	0.79-1.19 (20-30)	1.65 (42)	1.25 (30)	4.0 (100)	28 (700)	28 (700)
HVS-S-1513S-J-M6	350-500	1.04-1.33 (26-34)	1.80 (45)	1.30 (34)	5.0 (125)	35 (870)	35 (870)
HVS-S-1514S-J-M8	500-750	1.16-1.55 (29-39)	1.90 (48)	1.55 (40)	6.0 (150)	35 (870)	35 (870)
HVS-S-1514S-J-M9	750-1000	1.35-1.70 (34-43)	2.30 (58)	1.75 (43)	8.0 (200)	35 (870)	35 (870)
<i>M4 = ASBS-2-3/0, M5 = ASBS-2-350, M6 = ASBS-3/0-500, M8 = ASBS-500-750, M9 = ASBS-600-1000</i>							

ADDITIONAL PRODUCT INFORMATION

- Select the appropriate catalog number. All selections are based on the typical dimensions for both 100% and 133% insulated cables.
- Use the insulation OD, and jacket OD range as the final ordering criteria.
- Kits can be installed with either aluminum or copper compression connectors (connectors not included with kit).
- If external grounding is required, order an HVS-EG kit.
- Standard package: 1 kit/box
- Related Test Report: EDR-5440 and EDR-5444.
- For AL Mechanical Shear Bolt connector information request data sheet 9-1773440-4 and for CU request 165972.



HVS-J In-Line Splice for 1/C Jacketed Concentric Neutral Cables

FEATURES

- In addition to the unique internal moisture seal, the SJ/EJ kits feature the MBSM wraparound outer jacket which provides mechanical resistance to abrasion and impact, as well as an external moisture seal.
- Meets IEEE-404 standard requirements.

APPLICATIONS

- For 1/C jacketed concentric neutral cables rated 25 and 35 kV.

BENEFITS

- ♦ Provide stress control, rebuild the shielding systems, and restore primary cable insulation to 133% of the cable's original insulation level.
- ♦ Same range as prior HVS-1510S-J
- ♦ Range taking Aluminum or Copper shear bolts available separately

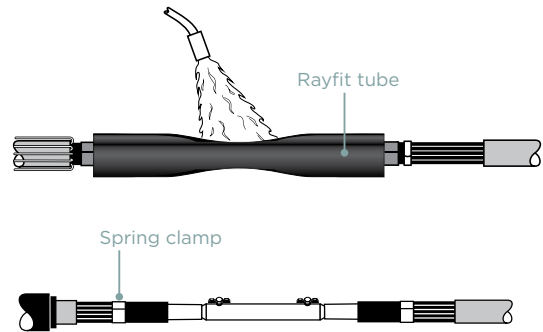
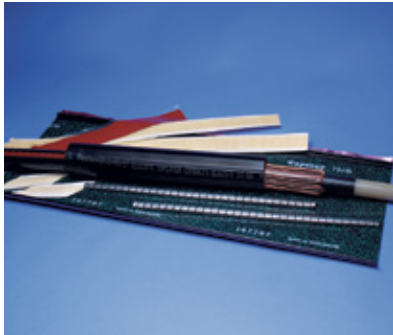

PRODUCT SELECTION INFORMATION: DIMENSIONS IN INCHES (MM)

Catalog Number	Conductor Size (AWG/kcmil)	Min - Max Insulator Dia. (A)	Jacket O.D. (max) (B)	Max Connector O.D. (C)	Max Connector Length (D)	Kit Installed Length (L)	Required Install Space (M)
HVS-2510E-J (25/28 kV)							
HVS-2511E-J	#1-250	0.90-1.20 (23-30)	1.55 (39)	1.10 (28)	4.0 (102)	40 (1016)	56 (1422)
HVS-2512E-J	350-500	1.20-1.50 (30-38)	1.95 (50)	1.35 (34)	6.0 (152)	48 (1219)	68 (1727)
HVS-2513E-J	750-1000	1.50-1.80 (38-46)	2.40 (61)	1.85 (47)	8.0 (203)	48 (1219)	70 (1778)
HVS-3510S-J (35 kV)							
HVS-3511S-J	1/0-3/0	0.95-1.35 (24-34)	1.55 (39)	1.00 (25)	5.0 (127)	44 (1118)	53 (1346)
HVS-3512S-J	4/0-500	1.20-1.70 (30-43)	2.10 (53)	1.60 (41)	8.0 (203)	48 (1219)	63 (1600)
HVS-3513S-J	600-1000	1.55-2.15 (39-55)	2.80 (71)	1.85 (47)	10.0 (254)	48 (1219)	64 (1626)

ADDITIONAL PRODUCT INFORMATION

- Select the appropriate catalog number. All selections are based on the typical dimensions for both 100% and 133%-insulated cables, manufactured in accordance with AEIC standard and commonly used connectors. Nominal insulation thickness (100%): 25 kV: 260 mils., 28 kV: 280 mils., 35 kV: 345 mils. Nominal insulation thickness (133%): 15 kV: 220 mils.
- For cables manufactured to other specifications, confirm selection with cable and connector dimensions.
- Kits do not contain connectors; order compression or solder connectors separately.
- If external grounding and/or shield interrupting is required, order an HVS-EG kit.
- Standard package: 1 kit/box.
- Related test reports: 15 kV: 25 kV: EDR-5150, 28 kV: EDR-5318, 35 kV: EDR-5157.

HVS-C-RJ In-Line Heat Shrinkable Repair Splices

FEATURES

- One kit replaces two conventional splices for most repairs
- Splice includes extra long tin plated aluminum shear bolt connector
- Each kit contains all of the components required for the complete joint assembly
- TE Raychem HVS joints have been qualified IEEE-404

APPLICATIONS

- For use with either Copper Tape Shield or Jacketed Concentric Neutral cables.

BENEFITS

- This series of splices utilizes the new triple-extrusion Rayfit splice sleeve which provides high recovery forces resulting in superior interfacial pressure, reduced shrink and installation time, and a slimmer space-saving profile.

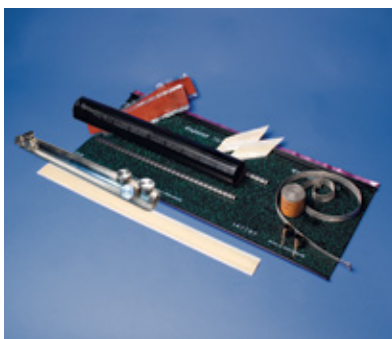

PRODUCT SELECTION INFORMATION: DIMENSIONS IN INCHES (MM)

Catalog Number	Conductor Size (AWG/kcmil)	Jacket O.D. (Max)	Min - Max Insulation Dia.	Connector Length	Connector Diameter	Kit Installed Length	Required Install Length
For Jacketed Concentric Neutral and Unjacketed Concentric Neutral Cables (-10 Series)							
HVS-C-1510S-RJ-MX (15 kV)							
HVS-C-1512S-RJ-M4	#2-2/0	1.20 (30)	.65-.95 (17-24)	17.3 (440)	0.95 (24)	48.0 (1200)	72.0 (1828)
HVS-C-1512S-RJ-M5	2/0-350	1.65 (42)	.79-1.19 (20-30)	17.3 (440)	1.29 (33)	48.0 (1200)	73.0 (1854)
HVS-C-1513S-RJ-M7	350-500	1.80 (45)	1.04-1.33 (26-34)	17.3 (440)	1.45 (37)	48.0 (1200)	74.0 (1879)
HVS-C-1514S-RJ-M8	500-750	1.90 (48)	1.16-1.55 (29-39)	17.3 (440)	1.66 (42)	48.0 (1200)	76.0 (1930)
HVS-C-1514S-RJ-M9	750-1000	2.30 (58)	1.35-1.70 (34-43)	17.3 (440)	1.81 (46)	48.0 (1200)	76.0 (1930)
<i>M4 = BSM-25/95-U-L440, M5 = BSM-95/240-U-L440, M7 = BSMU-120/300-L440, M8 = BSM-185/400-U-L440, M9 = BSMU-500-L440</i>							
HVS-C-2510S-RJ-MX (25 kV)							
HVS-C-2511S-RJ-M4	#2-3/0	1.65 (42)	.90-1.20 (23-30)	17.3 (440)	0.95 (24)	48.0 (1200)	72.0 (1828)
HVS-C-2512S-RJ-M5	4/0-350	2.15 (55)	1.03-1.50 (26-38)	17.3 (440)	1.29 (33)	48.0 (1200)	73.0 (1854)
HVS-C-2513S-RJ-M8	500-750	2.36 (60)	1.30-1.70 (34-43)	17.3 (440)	1.66 (42)	48.0 (1200)	76.0 (1930)
HVS-C-2514S-RJ-M9	1000	2.60 (65)	1.70-1.90 (43-49)	17.3 (440)	1.81 (46)	48.0 (1200)	76.0 (1930)
<i>M4 = BSM-25/95-U-L440, M5 = BSM-95/240-U-L440, M8 = BSM-185/400-U-L440, M9 = BSMU-500-L440</i>							
For Copper Tape Shield, Wire Shield, UniShield and Lead Sheath Cables (-20 Series)							
HVS-C-1520S-RJ-MX (15 kV)							
HVS-C-1522S-RJ-M4	#2-2/0	1.20 (30)	.65-.95 (17-24)	17.3 (440)	0.95 (24)	40.0 (1000)	69.0 (1752)
HVS-C-1522S-RJ-M5	2/0-350	1.65 (42)	.79-1.19 (20-30)	17.3 (440)	1.29 (33)	40.0 (1000)	69.0 (1752)
HVS-C-1523S-RJ-M7	350-500	1.80 (45)	1.04-1.33 (26-34)	17.3 (440)	1.45 (37)	44.0 (1100)	71.0 (1803)
HVS-C-1524S-RJ-M8	500-750	1.90 (48)	1.16-1.55 (29-39)	17.3 (440)	1.66 (42)	44.0 (1100)	71.0 (1803)
HVS-C-1524S-RJ-M9	750-1000	2.30 (58)	1.35-1.70 (34-43)	17.3 (440)	1.81 (46)	44.0 (1100)	71.0 (1803)
<i>M4 = BSM-25/95-U-L440, M5 = BSM-95/240-U-L440, M7 M8 = BSM-185/400-U-L440, M9 = BSMU-500-L440</i>							
HVS-C-2520S-RJ-MX (25 kV)							
HVS-C-2521S-RJ-M4	#2-3/0	1.65 (42)	.90-1.20 (23-30)	17.3 (440)	0.95 (24)	48.0 (1200)	72.0 (1828)
HVS-C-2522S-RJ-M5	4/0-350	2.15 (55)	1.03-1.50 (26-38)	17.3 (440)	1.29 (33)	48.0 (1200)	73.0 (1854)
HVS-C-2523S-RJ-M8	500-750	2.36 (60)	1.30-1.70 (34-43)	17.3 (440)	1.66 (42)	48.0 (1200)	76.0 (1930)
HVS-C-2524S-RJ-M9	1000	2.60 (65)	1.70-1.90 (43-49)	17.3 (440)	1.81 (46)	48.0 (1200)	76.0 (1930)
<i>M4 = BSM-25/95-U-L440, M5 = BSM-95/240-U-L440, M8 = BSM-185/400-U-L440, M9 = BSMU-500-L440</i>							

ADDITIONAL PRODUCT INFORMATION

- Select the appropriate catalog number. All selections are based on the typical dimensions for both 100 and 133% insulated cables, nominal insulation thickness 0.175-0.220.
- Use the insulation OD, and jacket OD range as the final ordering criteria.
- Standard package: 1 kit/box
- Related Test Report: EDR-5440, EDR-5444, EDR-5473, and IEEE 404 for 105°C of Splice and Terminations.
- For AL Mechanical shear bolt connector information request data sheet.



HVS-C-1520S In-Line Splice for 1/C Shielded Cable (15 kV)

FEATURES

- Reduced shrink time
- Improved heat transfer
- Significantly increased recovery forces
- Reduced overall diameters and length
- Optional copper shear bolt connector available
- Meets IEEE-404 standard requirements.

APPLICATIONS

- FOR 1/C shielded cables up to 15 kV

BENEFITS

- ♦ Feature a triple extrusion tube which provides increased recovery forces, reduced shrinking time and improved profile conformity.

HVS-C-1520S

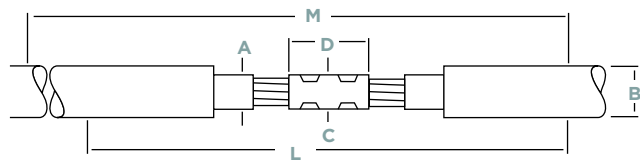
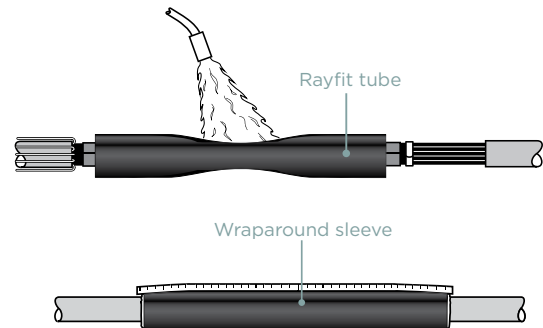
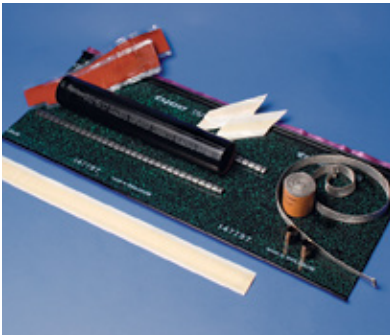

PRODUCT SELECTION INFORMATION: DIMENSIONS IN INCHES (MM)

Catalog Number	Conductor Size (AWG/kcmil)	Min - Max Insulator Dia. (A)	Jacket O.D. (max) (B)	Max Connector O.D. (C)	Max Connector Length (D)	Kit Installed Length (L)	Required Install Space (M)
HVS-C-1520S Splice for Compression Connector (not included)							
HVS-C-1521S	#2-2/0	0.65-0.95 (17-24)	1.20 (30)	0.80 (20)	4.0 (100)	28 (700)	28 (700)
HVS-C-1522S	3/0-400	0.85-1.30 (23-33)	1.65 (42)	1.20 (30)	5.0 (125)	28 (700)	28 (700)
HVS-C-1523S	500-750	1.10-1.55 (28-47)	1.90 (48)	1.45 (44)	6.0 (150)	35 (870)	35 (870)
HVS-C-1524S	750-1000	1.30-1.90 (33-48)	2.30 (58)	1.85 (47)	8.0 (200)	35 (870)	35 (870)
HVS-C-1520S with Copper Shear Bolt (connector included)							
HVS-C-1522S-M1	3/0-400	0.85-1.30 (23-33)	1.65 (30)	1.20 (30)	4.0 (100)	28 (700)	28 (700)
HVS-C-1523S-M2	500-750	1.10-1.55 (28-47)	1.90 (47)	1.45 (37)	5.0 (125)	35 (870)	35 (870)

M1 = CSBS-20C-500C-SOS, M2 = CSBS-300C-750C-SOS

NOTE: only the above two kits are available with connectors.

ADDITIONAL PRODUCT INFORMATION

- Select the appropriate catalog number. All selections are based on the typical dimensions for both 100% and 133% insulated cables, nominal insulation thickness 0.175-0.220".
- Use the insulation OD, and jacket OD as the final ordering criteria.
- Kits can be installed with either aluminum or copper compression connectors (connectors not included with kit).
- If external grounding, order an HVS-EG kit.
- Standard package: 1 kit/box
- Related test reports: EDR-5440 for HVS-C, IEEE 404 and IEEE-48 for 105°C of Splice and Terminations.
- For CU Mechanical shear bolt connector information request data sheet 165972.

HVS-S-1520S In-Line Splice for 1/C Shielded Cables (15 kV)

FEATURES

- Reduced shrink time
- Improved heat transfer
- Significantly increased recovery forces
- Reduced overall diameters and length
- Tin plated aluminum shear bolt Connector (CU/AL)
- Meets IEEE-404 standard requirements.

APPLICATIONS

- For 1/C Metallic Tape, Wire Shield, UniShield, or Lead Sheath Cables up to 15 kV

BENEFITS

- ♦ Feature a triple extrusion tube which provides increased recovery forces, reduced shrinking time and improved profile conformity.

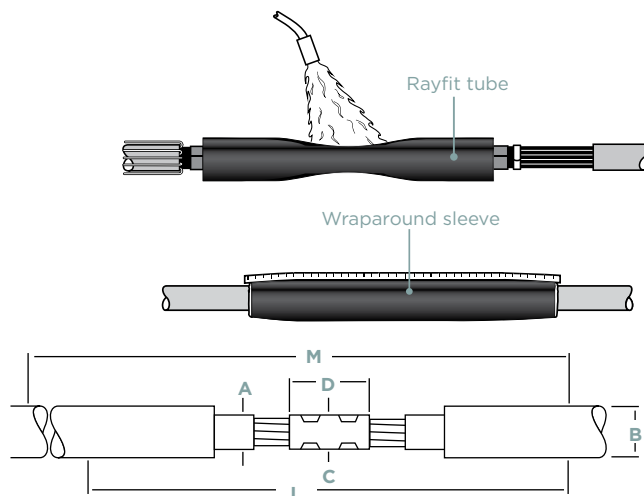
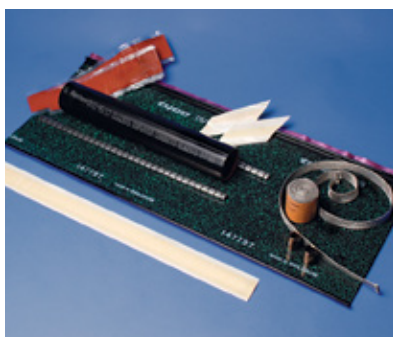

PRODUCT SELECTION INFORMATION: DIMENSIONS IN INCHES (MM)

Catalog Number	Conductor Size (AWG/kcmil)	Min - Max Insulator Dia. (A)	Jacket O.D. (max) (B)	Max Connector O.D. (C)	Max Connector Length (D)	Kit Installed Length (L)	Required Install Space (M)
HVS-S-1520S splice with Al Shear Bolt Connector							
HVS-S-1522S-M4	#2-2/0	0.65-0.95 (17-24)	1.20 (30)	.095 (24)	2.5 (65)	28 (700)	28 (700)
HVS-S-1522S-M5	2/0-350	0.79-1.19 (20-30)	1.65 (42)	1.25 (30)	4.0 (100)	28 (700)	28 (700)
HVS-S-1523S-M6	350-500	1.04-1.33 (26-34)	1.80 (45)	1.30 (34)	5.0 (125)	35 (870)	35 (870)
HVS-S-1524S-M8	500-750	1.16-1.55 (29-39)	1.90 (48)	1.55 (40)	6.0 (150)	35 (870)	35 (870)
HVS-S-1524S-M9	750-1000	1.35-1.70 (34-43)	2.30 (58)	1.75 (43)	8.0 (200)	35 (870)	35 (870)

M4 = ASBS-2-3/0, M5 = ASBS-2-350, M6 = ASBS-3/0-500, M8 = ASBS-500-750, M9 = ASBS-600-1000

Catalog Number	Min - Max Insulation Diameter	Moisture-Blocked Braid Length	Braid Size (AWG)
HVS-EG-3-1	0.30-1.25 (8-32)	36 (914)	#8
HVS-EG-3-2	1.00-2.15 (25-55)	36 (914)	#6
HVS-EG-3-3	1.55-3.40 (39-86)	36 (914)	#4

ADDITIONAL PRODUCT INFORMATION

- Select the appropriate catalog number. All selections are based on the typical dimensions for both 100% and 133% insulated cables, nominal insulation thickness 0.175-0.220".
- Use the insulation O.D. and jacket O.D. range as the final ordering criteria.
- Kits contain Tin-plated Aluminum shear bolt connector for use with either CU or AL conductors.
- If external grounding, order an HVS-EG kit.
- Standard package: 1 kit/box
- Related Test Report: EDR-5440 for HVS-C
- For AL Mechanical shear bolt connector information request data sheet 9-1773440-4.

HVS In-Line Splices for 1/C Shielded Cable (5-35 kV)

FEATURES

- Kits contain a solderless grounding kit, consisting of a ground clamp, a ground braid, and a shielding mesh.
- Heat shrink feature allows the kits to accommodate out-of-round, out-of-spec cable.
- Some kits contain tube for outer layer.
- Meets IEEE-404 standard requirements.

APPLICATIONS

- For 1/C Shielded cables from 5-35 kV
- For use on copper tape, wire shield, lead sheath, and UniShield cables.

BENEFITS

- Pre-engineered to offer a compact, low-profile installation with a minimum diameter buildup.

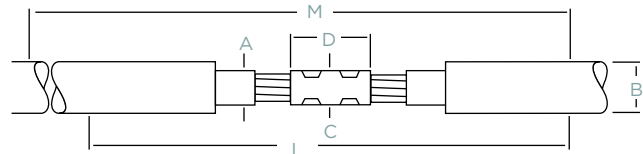

PRODUCT SELECTION INFORMATION: DIMENSIONS IN INCHES (MM)

Catalog Number	Conductor Size (AWG/kcmil)	Min - Max Insulator Dia. (A)	Jacket O.D. (max) (B)	Max Connector O.D. (C)	Max Connector Length (D)	Kit Installed Length (L)	Required Install Space (M)	
HVS-820S	(5 kV)	(5/8 kV)						
HVS-821S	#6-2/0	#6-#2	0.35-0.65 (9-17)	0.80 (20)	0.50 (13)	3.0 (76)	24 (610)	44 (1118)
HVS-822S	3/0-300	#1-4/0	0.55-0.90 (14-23)	1.15 (29)	0.75 (19)	4.25 (108)	24 (610)	45 (1143)
HVS-823S	350-750	250-350	0.80-1.25 (20-32)	1.80 (46)	1.10 (28)	6.0 (152)	27 (686)	50 (1270)
HVS-824S	1000-1500	500-750	1.00-1.60 (25-41)	2.30 (58)	1.45 (37)	8.0 (203)	30 (762)	56 (1422)
HVS-825S		750-1000	1.30-2.25 (33-57)	2.45 (62)	1.85 (47)	8.0 (203)	30 (762)	56 (1422)
HVS-1520S	(15 kV)							
HVS-1521S		#2-4/0	0.65-1.05 (17-27)	1.25 (32)	0.90 (23)	4.25 (108)	27 (686)	54 (1372)
HVS-1522S		250-350	0.90-1.30 (23-33)	1.50 (38)	1.20 (30)	5.5 (140)	28 (711)	56 (1422)
HVS-1523S		500-750	1.10-1.60 (28-41)	1.85 (47)	1.60 (41)	8.0 (203)	30 (762)	59 (1499)
HVS-1524S		750-1000	1.25-1.80 (32-46)	2.10 (53)	1.85 (47)	8.0 (203)	34 (864)	67 (1702)
HVS-1525S		1250-2000	1.60-2.50 (41-64)	2.80 (71)	2.40 (61)	8.0 (203)	40 (1016)	74 (1880)
HVS-1520S-W (15 kV with Wraparound Rejacketing Sleeve)								
HVS-1521S-W		#2-4/0	0.65-1.05 (17-27)	1.25 (32)	0.90 (23)	4.25 (108)	28 (711)	39 (990)
HVS-1522S-W		250-350	0.90-1.30 (23-33)	1.50 (38)	1.20 (30)	5.50 (140)	28 (711)	40 (1016)
HVS-1523S-W		500-750	1.10-1.60 (28-41)	1.85 (47)	1.60 (41)	8.00 (203)	30 (762)	45 (1143)
HVS-1524S-W		750-1000	1.25-1.80 (32-46)	2.10 (53)	1.85 (47)	8.00 (203)	34 (864)	49 (1244)
HVS-1525S-W		1250-2000	1.60-2.50 (41-64)	2.80 (71)	2.40 (61)	11.00 (279)	40 (1016)	54 (1371)
HVS-2520S	(25 kV)							
HVS-2521S		#1-250	0.90-1.20 (23-31)	1.50 (38)	1.10 (28)	4.0 (102)	40 (1016)	40 (1016)
HVS-2522S		350-500	1.20-1.50 (31-38)	1.95 (50)	1.35 (34)	6.0 (152)	40 (1016)	40 (1016)
HVS-2523S		750-1000	1.50-1.80 (38-46)	2.40 (61)	1.85 (47)	8.0 (203)	40 (1016)	40 (1016)
HVS-3520S	(35 kV)							
HVS-3521S		1/0-3/0	0.95-1.35 (24-34)	1.55 (39)	1.20 (30)	4.0 (102)	40 (1016)	53 (1346)
HVS-3522S		4/0-600	1.20-1.70 (31-43)	2.10 (53)	1.50 (38)	6.0 (152)	44 (1118)	62 (1575)
HVS-3523S		600-1000	1.55-2.15 (39-55)	2.80 (71)	1.85 (47)	10.0 (254)	44 (1118)	67 (1702)
HVS-3524S		1250-2000	2.1-2.63 (53-66)	3.0 (76)	2.6 (66)	10 (254)	44 (1118)	45 (1145)

ADDITIONAL PRODUCT INFORMATION

- Select the appropriate catalog number. All selections are based on the typical dimensions of 100% insulated cables, manufactured in accordance with AIEC standard. Nominal insulation thickness (100%): 5 kV: 90 mils., 5/8 kV: 115 mils., 15 kV: 175 mils., 25 kV: 260 mils., 35 kV: 345 mils. Nominal insulation thickness (133%): 15 kV: 220 mils. Check the jacket O.D. on the 15 kV, 133%-insulated 4/0 and 750-kcmil cables to ensure they fall within the use range specified. If you have any questions, contact your TE sales engineer or representative.
- For cables manufactured to other specifications, confirm selection with cable and connector dimensions.
- HVS-SHM kits are available if the diameter of one of your cables is not within the standard range.
- Kits do not contain connectors; order compression or solder-connectors separately. Standard package: 1 kit/box
- If external grounding is required, order an HVS-EG kit.
- Related test reports: HVS 5-8 kV: EDR-5181. HVS 15 kV: EDR-5114, HVS 25 kV: EDR-5150, HVS 25-35 kV: EDR-5197, HVS-1520S-W: EDR-5225

HVS-C-1530S 1/C LC Shielded and Flat Strap Cables (15 kV)

FEATURES

- Designed to withstand fault current duty of 10-kA rms for 100 cycles
- Rated to IEEE 404
- Ground connections are made using heavy duty stainless steel spring clamps and tinned copper braid.
- The ground connections have been tested to multiple reclosed faults in excess of 13-kA rms without damage.
- Meets IEEE-404 standard requirements.

APPLICATIONS

- For Longitudinally Corrugated (LC) Shield or Flat Strap Neutral (FS)

BENEFITS

- Feature a metal laminated wraparound re-jacketing sleeve that reduces moisture-vapor transmission.
- This tough sleeve also protects the splice from coincidental abrasion, back fill and handling damage.

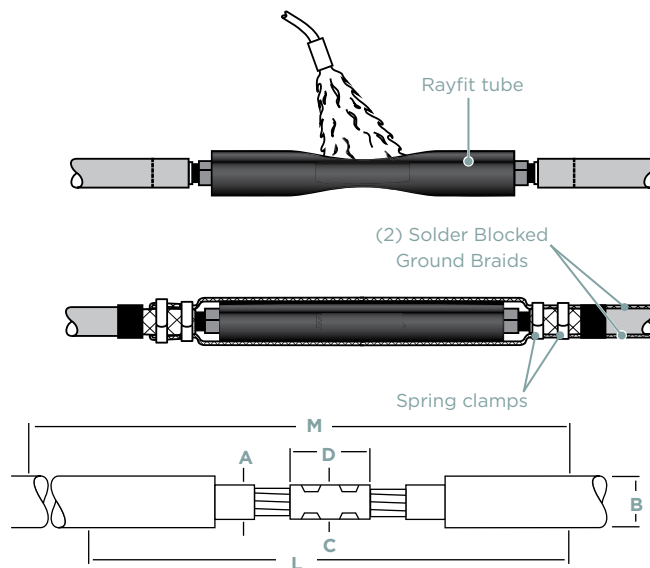

PRODUCT SELECTION INFORMATION: DIMENSIONS IN INCHES (MM)

Catalog Number	Conductor Size (AWG/kcmil)	Min - Max Insulator Dia. (A)	Jacket O.D. (max) (B)	Max Connector O.D. (C)	Max Connector Length (D)	Kit Installed Length (L)	Required Install Space (M)
HVS-C-1530S without Connector							
HVS-C-1531S	#2-2/0	0.65-0.95 (17-24)	1.20 (30)	0.80 (20)	4.0 (100)	28 (700)	28 (700)
HVS-C-1532S	3/0-400	0.85-1.30 (23-33)	1.65 (42)	1.20 (30)	5.0 (140)	28 (700)	28 (700)
HVS-C-1533S	500-750	1.10-1.55 (28-39)	1.90 (48)	1.45 (37)	6.0 (150)	35 (870)	35 (870)
HVS-C-1534S	750-1000	1.30-1.90 (33-48)	2.30 (58)	1.85 (47)	8.0 (200)	35 (870)	35 (870)
HVS-C-1530S with Copper Mechanical Shear Bolt Connector							
HVS-C-1532S-M1	3/0-400	1.10-1.55 (28-39)	1.20 (30)	1.20 (30)	4.0 (100)	28 (700)	28 (700)
HVS-C-1533S-M2	500-750	1.10-1.55 (28-47)	1.45 (37)	1.45 (37)	5.5 (140)	35 (870)	35 (870)
<i>M1 = CSBS-20C-500C-SOS, M2 = CSBS-300C-750C-SOS</i>							
HVS-S-1530S with Aluminum Mechanical Shear Bolt Connector							
HVS-S-1531S-M4	#2-2/0	0.65-0.95 (17-24)	1.20 (30)	0.95 (24)	2.5 (65)	28 (700)	28 (700)
HVS-S-1532S-M5	2/0-350	0.79-1.19 (20-30)	1.65 (42)	1.25 (30)	4.0 (100)	28 (700)	28 (700)
HVS-S-1533S-M6	350-500	1.04-1.33 (26-34)	1.80 (45)	1.30 (34)	5.5 (140)	35 (870)	35 (870)
HVS-S-1534S-M8	500-750	1.16-1.55 (29-39)	1.90 (48)	1.55 (40)	6.0 (150)	35 (870)	35 (870)
HVS-S-1534S-M9	750-1000	1.35-1.70 (34-43)	2.30 (58)	1.75 (43)	8.0 (200)	35 (870)	35 (870)
<i>M4 = ASBS-2-3/0, M5 = ASBS-2-350, M6 = ASBS-3/0-500, M8 = ASBS-500-750, M9 = ASBS-600-1000</i>							

ADDITIONAL PRODUCT INFORMATION

- Select the appropriate catalog number. All selections are based on the typical dimensions for both 100% and 133% insulated cables, nominal insulation thickness 0.175-0.220 inch.
- Use the insulation O.D. and jacket O.D. range as the final ordering criteria.
- Kits can be installed with either aluminum or copper compression connectors (connectors not included with kit).
- Kits are supplied with solder blocked ground braids, and a standard package: 1 kit/box
- Related Test Report: EDR-5440 and EDR-5444, IEEE 404-2006 and IEEE 48 draft 2006 for 105°C of Splice and Terminations.
- For AL Mechanical shear bolt connector information request data sheet 9-1773440-4 and for CU request 165972.

HVS-LC Splice Kits for 1/C LC and Flat Strap Shield Cable (25-35 kV)

FEATURES

- Designed to withstand fault current duty of 10-kA rms for 10 cycles
- Ground connections are made using heavy duty stainless steel spring clamps and tinned copper braid.
- The ground connections have been tested to multiple reclosed faults in excess of 13-kA rms without damage.
- Meets IEEE-404 standard requirements.

APPLICATIONS

- For Longitudinally Corrugated (LC) Shield or Flat Strap Neutral (FS)

BENEFITS

- Feature a metal laminated wraparound re-jacketing sleeve that reduces moisture-vapor transmission.
- This tough sleeve also protects the splice from coincidental abrasion, back fill and handling damage.

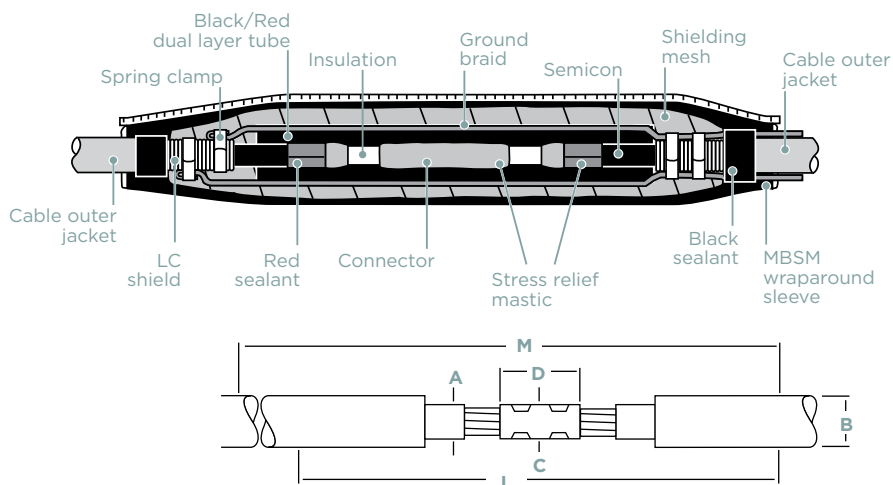

PRODUCT SELECTION INFORMATION: DIMENSIONS IN INCHES (MM)

Catalog Number	Conductor Size (AWG/kcmil)	Min - Max Insulator Dia. (A)	Jacket O.D. (max) (B)	Max Connector O.D. (C)	Max Connector Length (D)	Kit Installed Length (L)	Required Install Space (M)
HVS-2530-LC (25 kV)							
HVS-2531-LC	#1-250	0.90-1.20 (22-30)	1.55 (39)	1.10 (28)	4.0 (102)	36 (914)	48 (1219)
HVS-2532-LC	350-500	1.20-1.50 (30-38)	1.95 (50)	1.35 (34)	6.0 (152)	37 (940)	50 (1270)
HVS-2533-LC	750-1000	1.50-1.80 (38-46)	2.40 (61)	1.85 (47)	8.0 (203)	39 (991)	54 (1372)
HVS-3530-LC (35 kV)							
HVS-3531-LC	1/0-3/0	0.95-1.35 (24-34)	1.55 (39)	1.00 (25)	4.0 (102)	40 (1016)	52 (1321)
HVS-3532-LC	4/0-500	1.30-1.70 (33-43)	2.10 (53)	1.60 (41)	5.5 (140)	40 (1016)	58 (1473)
HVS-3533-LC	750-1000	1.65-2.15 (42-55)	2.80 (71)	1.85 (47)	8.0 (203)	48 (1219)	64 (1626)

ADDITIONAL PRODUCT INFORMATION

- Select the appropriate catalog number. All selections are based on the typical dimensions of 100% and 133% insulated cables, manufactured in accordance with AEIC standard and commonly used connectors. Nominal insulation thickness (100%): 15 kV: 175 mils. 25 kV: 260 mils. 35 kV: 345 mils. Nominal insulation thickness (133%): 15 kV: 220 mils.
- For cables manufactured to other specifications, confirm selection with cable and connector dimensions.
- Kits do not contain connectors; order compression or solder connectors separately.
- HVS kits are supplied with two pieces of braid to provide fault current carrying capacity over the splice. User should verify compatibility of supplied braids to application on LC shield cable.
- Standard package: 1 kit/box
- Related test reports: 25 kV: EDR-5150, 35 kV: EDR-5157

TECK Splices for TECK Cable (1000 V-15 kV)

FEATURES

- Positive environmental sealing
- Complete grounding and bonding
- Fast, easy installation
- Slim profile
- CSA certified to C22.2, No. 198.2.
- Meets IEEE-404 standard requirements.

APPLICATIONS

- Designed specifically for TECK power cable, TE's Raychem TECK splice kits are easy to install and are ideal for underground and cable tray applications.
- For use on 1/C and 4/C 1000-V TECK cable and 3/C 5 kV TECK cable.

BENEFITS

- ♦ The splice is protected from moisture and mechanical damage by two layers of adhesive-lined WCSM heavy-wall tubing and one layer of CRSM wraparound sleeve.

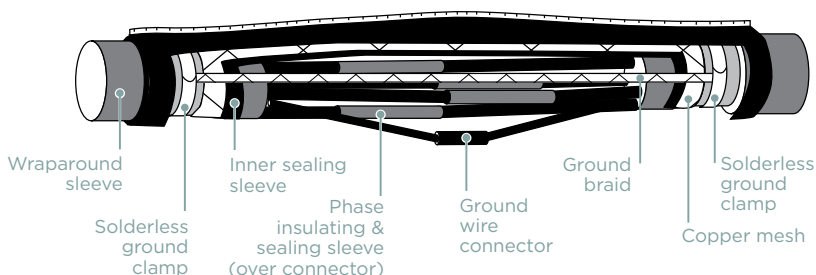
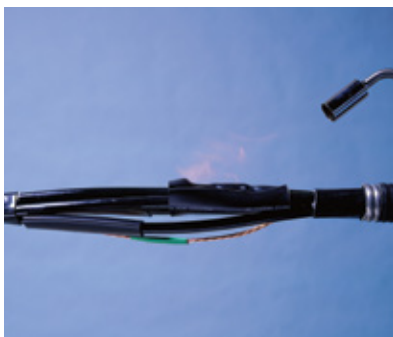

PRODUCT SELECTION INFORMATION: DIMENSIONS IN INCHES (MM)

Catalog Number	Nominal Cable Range	Min - Max Insulation Dia.	Inner Jacket Dia. Range	Outer Jacket Dia. Range	Maximum Connector Length	Splice Installed Length
Low-Voltage 1/C						
TECK-10	#6-#1 AWG	0.30-0.50 (10-15)	0.40-0.80 (10-20)	0.70-1.10 (20-30)	2.0 (50)	22 (560)
TECK-11	1/0-3/0 AWG	0.45-0.70 (10-20)	0.65-0.90 (15-25)	1.00-1.15 (25-30)	3.5 (90)	22 (560)
TECK-12	4/0-350 MCM	0.60-0.90 (15-25)	0.80-1.10 (20-30)	1.10-1.45 (30-35)	5.0 (125)	25 (635)
TECK-13	400-750 MCM	0.80-1.20 (20-30)	1.10-1.50 (30-40)	1.40-1.80 (35-45)	7.5 (190)	29 (735)
TECK-14	1000-2000 MCM	1.20-2.10 (30-55)	1.50-20.40 (40-60)	1.90-2.80 (50-70)	8.0 (205)	40 (1015)
Low-Voltage 4/C						
TECK-41	#14-#4		0.50-1.20 (15-30)	0.70-1.45 (20-35)	2.0 (50)	25 (650)
TECK-42	#2-3/0		1.00-1.70 (25-45)	1.30-2.10 (35-55)	3.0 (75)	25 (650)
TECK-43	4/0-400		1.50-2.50 (40-65)	2.00-3.00 (50-70)	4.0 (100)	40 (1015)
TECK-44	500-1000		2.00-3.50 (50-90)	2.50-4.00 (65-100)	6.5 (165)	40 (1015)
5 kV Unshielded 3/C						
TECK-531	#2-4/0	0.40-0.75 (10-20)	1.20-2.00 (30-50)	1.50-2.40 (40-60)	3.5 (90)	40 (1015)
TECK-532	250-750	0.65-1.20 (15-30)	1.80-3.00 (45-75)	2.20-3.25 (55-85)	6.0 (150)	48 (1220)
15 kV Shielded 3/C						
HVSA-3-1521S-TECK	#2-4/0 AWG	0.65-1.05 (17-27)	1.75-4.5 (45-115)	2.50-6.5 (65-165)	4.25 (105)	72 (1830)
HVSA-3-1522S-TECK	250-350 kcmil	0.90-1.30 (23-33)	2.50-6.0 (65-150)	2.50-6.5 (65-165)	5.5 (140)	80 (2030)
HVSA-3-1523S-TECK	500-750 kcmil	1.10-1.60 (28-41)	2.50-6.0 (65-150)	2.50-6.5 (65-165)	8.0 (200)	80 (2030)
HVSA-3-1524S-TECK	750-1000 kcmil	1.25-1.80 (32-46)	2.50-6.0 (65-150)	2.50-6.5 (65-165)	8.0 (200)	80 (2030)

ADDITIONAL PRODCUT INFORMATION

- Select the appropriate catalog number based on cable size. Confirm selection with dimensions to assure proper sizing.
- Kits do not contain connectors or lugs and should be ordered separately. Installed connector or lug diameter must be within use range.
- CSA certification applies only to applications up to 1000 volts.
- Standard package: 1 kit/box
- Related test report: 1000 volts: EDR-5194

HVS-SHIM Heat Shrinkable Shim Kits (5-35kV)

APPLICATIONS

- Use TE's Raychem HVS-SHIM kit to increase the insulation diameter of a polymeric cable, allowing it to fit in the use range of a standard splice kit. For use on copper tape, LC shield, wire shield, lead sheath, UniShield, and jacketed/unjacketed concentric neutral cables.



SELECTING THE APPROPRIATE SHIM KIT:

- Verify that the insulation diameters of the two cables to be spliced do not fall within the insulation range of any standard splice kit.
- Select the splice kit that fits the larger of the two cables within the kit's insulation-diameter use range. If the larger cable fits in more than one kit, choose the smaller kit.
- Determine the minimum cable insulation diameter for the kit and find that value in the first column below. Example: An HVS-1523S kit has a cable insulation range of 1.10-1.60 inches. Therefore, the minimum cable insulation diameter for this kit is 1.10 inches.
- In the second column, find the insulation diameter range in which the smaller cable falls. Note: If the smaller cable does not fit within any of the specified ranges in the second column, a standard shim cannot be used for your application. Contact your local TE representative for more information.
- In the third column, find the correct HVS-SHIM kit to order.

PRODUCT SELECTION INFORMATION: DIMENSIONS IN INCHES (MM)

Catalog Number	Minimum Cable Insulation Diameter	Smaller Cable Insulation Diameter Range
HVS-SHIM-1	0.80 (20)	0.60-0.80 (15-20)
HVS-SHIM-1	0.85 (22)	0.65-0.85 (17-22)
HVS-SHIM-1	0.90 (23)	0.70-0.90 (18-23)
HVS-SHIM-1	0.95 (24)	0.80-0.95 (20-24)
HVS-SHIM-1	1.00 (25)	0.85-1.00 (22-25)
HVS-SHIM-1	1.05 (27)	0.90-1.05 (23-27)
HVS-SHIM-2		0.70-0.90 (18-23)
HVS-SHIM-3	1.10 (28)	0.90-1.10 (23-28)
HVS-SHIM-4		0.70-0.90 (18-23)
HVS-SHIM-3	1.15 (29)	0.95-1.15 (24-29)
HVS-SHIM-4		0.80-0.95 (20-24)
HVS-SHIM-3	1.20 (30)	1.00-1.20 (25-30)
HVS-SHIM-4		0.85-1.00 (22-25)
HVS-SHIM-3	1.25 (32)	1.10-1.25 (28-32)
HVS-SHIM-4		0.95-1.10 (24-28)
HVS-SHIM-3	1.30 (33)	1.15-1.30 (29-33)
HVS-SHIM-4		1.00-1.15 (25-29)
HVS-SHIM-3	1.35 (34)	1.20-1.35 (30-34)
HVS-SHIM-5		1.00-1.20 (25-30)
HVS-SHIM-3	1.40 (36)	1.25-1.40 (32-36)
HVS-SHIM-5		1.05-1.25 (27-32)
HVS-SHIM-3	1.45 (37)	1.30-1.45 (33-37)
HVS-SHIM-5		1.15-1.30 (29-33)
HVS-SHIM-3	1.50 (38)	1.35-1.50 (34-38)
HVS-SHIM-5		1.20-1.35 (30-34)
HVS-SHIM-6	1.55 (39)	1.35-1.55 (34-39)
HVS-SHIM-6	1.60 (41)	1.40-1.60 (36-41)
HVS-SHIM-6	1.65 (42)	1.45-1.65 (37-42)
HVS-SHIM-6	1.70 (43)	1.50-1.70 (38-43)
HVS-SHIM-6	1.75 (44)	1.55-1.75 (39-44)
HVS-SHIM-6	1.80 (46)	1.60-1.80 (41-46)

ADDITIONAL PRODUCT INFORMATION

- Select the appropriate shim kit catalog number based on actual cable dimensions and TE's splice kit use range.
- TE's splice kit and shim kits are sold separately.
- Shim kits do not contain connectors. Order a size-reducing connector separately.
- Contact your local TE sales engineer or representative for cable sizes not listed in the selection table.
- Standard package: 1 kit/box

HVS-3 In-Line Splices for 3/C Shielded Cable (5-25 kV)

FEATURES

- CRSM wraparound jacket included with each splice.
- Meets IEEE-404 standard requirements.

APPLICATIONS

- For use on copper tape, wire shield, lead sheath, and UniShield cables.

BENEFITS

- ♦ The three conductor cable splice kits are designed to rebuild all layers of the cable. These kits meet the same performance criteria as our single conductor splice kits.

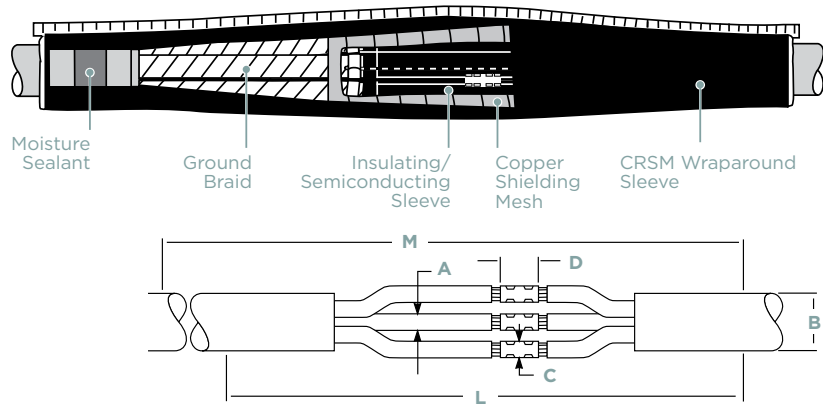
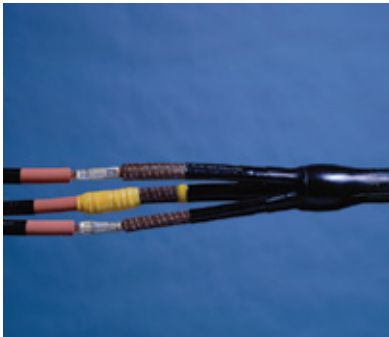

PRODUCT SELECTION INFORMATION: DIMENSIONS IN INCHES (MM)

Catalog Number	Conductor Size (AWG/kcmil)		Min - Max Insulation Dia. (A)	Jacket O.D. (max) (B)	Max Connector O.D. (C)	Max Connector Length (D)	Kit Installed Length (L)	Required Installation Space (M)
	(5 kV)	(8 kV)						
HVS-3-820S	(5 kV)	(8 kV)						
HVS-3-821S	#6-2/0*	#6-#2	0.35-0.65 (9-17)	0.90 (23)	0.50 (13)	3.0 (76)	40 (1016)	50 (1270)
HVS-3-822S	3/0-300*	#1-4/0	0.55-0.90 (14-23)	1.30 (33)	0.75 (19)	4.25 (108)	48 (1219)	58 (1473)
HVS-3-823S	350-750*	250-350	0.80-1.25 (20-32)	1.30 (33)	1.10 (28)	6.0 (152)	48 (1219)	58 (1473)
HVS-3-824S	1000-1500*	500-750	1.00-1.60 (25-41)	1.55 (39)	1.45 (37)	8.0 (203)	59 (1499)	69 (1753)
HVS-3-825S		750-1000	1.30-2.25 (33-57)	1.55 (39)	1.85 (47)	8.0 (203)	59 (1499)	69 (1753)
HVS-3-1520S		(15 kV)						
HVS-3-1521S		#2-4/0	0.65-1.05 (17-27)	1.30 (33)	0.90 (23)	4.25 (108)	59 (1499)	69 (1753)
HVS-3-1522S		250-350	0.90-1.30 (23-33)	1.55 (39)	1.15 (29)	5.5 (140)	59 (1499)	69 (1753)
HVS-3-1523S		500-750	1.10-1.60 (28-41)	1.55 (39)	1.60 (41)	8.0 (203)	67 (1702)	77 (1956)
HVS-3-1524S		750-1000	1.25-1.80 (32-46)	2.40 (61)	1.85 (47)	8.0 (203)	67 (1702)	77 (1956)
HVS-3-2520S		(25 kV)						
HVS-3-2521S		#1-250	0.90-1.20 (23-31)	1.65 (42)	1.10 (28)	4.0 (102)	59 (1499)	69 (1753)
HVS-3-2522S		350-500	1.20-1.50 (31-38)	1.65 (42)	1.35 (34)	6.0 (152)	67 (1702)	77 (1956)
HVS-3-2523S		750-1000	1.50-1.80 (38-46)	2.50 (64)	1.85 (47)	8.0 (203)	72 (1829)	82 (2032)

ADDITIONAL PRODUCT INFORMATION

- * Select the appropriate catalog number. All selections are based on the typical dimensions of 100% insulated cables and commonly used connectors, manufactured in accordance with AEIC standard. Nominal insulation thickness (100%): 5 kV: 90 mils. 8 kV: 115 mils., 15 kV: 175 mils., 25 kV: 260 mils. Nominal insulation thickness (133%): 15 kV: 220 mils.
- For cables manufactured to other specifications, confirm selection with cable and connector dimensions.
- If using 5/8kV (115-mil) cable, use 8 kV selection.
- For 35kV applications or an off-the-shelf 3/C splice alternative, select three appropriate single-conductor kits and one HVS-3/C accessory kit.
- Kits do not contain connectors; order compression or solder connectors separately.
- If external grounding and/or shield interrupting is required, order an HVS-EG-3 kit.
- Standard package: 1 kit/box
- Related test reports: 5/8 kV: EDR-5181, 15 kV: EDR-5114, 25 kV: EDR-5048, 25-35 kV: EDR-5197

HVSA-3 In-Line Splices for 3/C Armor Cable (5-15 kV)

FEATURES

- CRSM wraparound jacket included with each splice.
- Meets IEEE-404 standard requirements.

APPLICATIONS

- For use on copper tape, wire shield, lead sheath, and UniShield cables.

BENEFITS

- The three conductor cable splice kits are designed to rebuild all layers of the cable. These kits meet the same performance criteria as our single conductor splice kits.

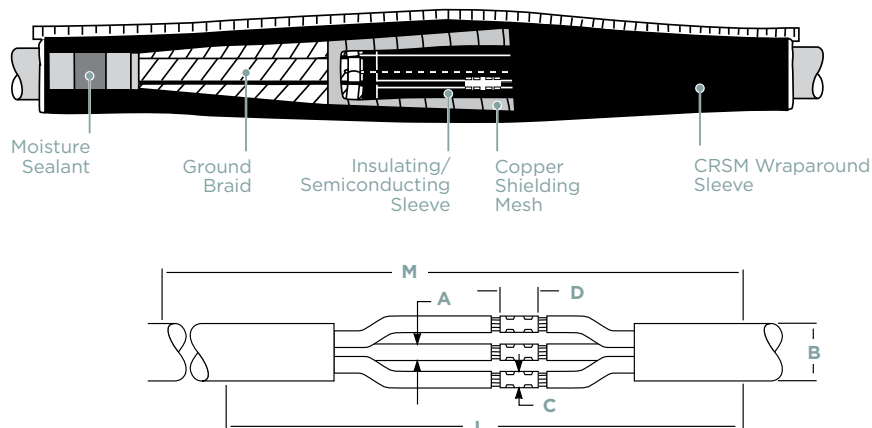

PRODUCT SELECTION INFORMATION: DIMENSIONS IN INCHES (MM)

Catalog Number	Conductor Size (AWG/kcmil)		Min - Max Insulation Dia. (A)	Jacket O.D. (max) (B)	Max Connector O.D. (C)	Max Connector Length (D)	Kit Installed Length (L)	Required Installation Space (M)
HVS-3-820S	(5 kV)	(8 kV)						
HVS-3-821S	#6-2/0	#6-#2	0.35-0.65 (9-17)	0.90 (23)	0.50 (13)	3.0 (76)	40 (1016)	50 (1270)
HVS-3-822S	3/0-300	#1-4/0	0.55-0.90 (14-23)	1.30 (33)	0.75 (19)	4.25 (108)	48 (1219)	58 (1473)
HVS-3-823S	350-750	250-350	0.80-1.25 (20-32)	1.30 (33)	1.10 (28)	6.0 (152)	48 (1219)	58 (1473)
HVS-3-824S	1000-1500	500-750	1.00-1.60 (25-41)	1.55 (39)	1.45 (37)	8.0 (203)	59 (1499)	69 (1753)
HVS-3-825S		750-1000	1.30-2.25 (33-57)	1.55 (39)	1.85 (47)	8.0 (203)	59 (1499)	69 (1753)
HVS-3-1520S		(15 kV)						
HVS-3-1521S		#2-4/0	0.65-1.05 (17-27)	1.30 (33)	0.90 (23)	4.25 (108)	59 (1499)	69 (1753)
HVS-3-1522S		250-350	0.90-1.30 (23-33)	1.55 (39)	1.15 (29)	5.5 (140)	59 (1499)	69 (1753)
HVS-3-1523S		500-750	1.10-1.60 (28-41)	1.55 (39)	1.60 (41)	8.0 (203)	67 (1702)	77 (1956)
HVS-3-1524S		750-1000	1.25-1.80 (32-46)	2.40 (61)	1.85 (47)	8.0 (203)	67 (1702)	77 (1956)

Note: For voltages higher than 15kV, please see HVSA MOD Kits or please consult a TE representative.

ADDITIONAL PRODUCT INFORMATION

- Select the appropriate catalog number. All selections are based on the typical dimensions of 100% insulated cables and commonly used connectors, manufactured in accordance with AEIC standard. Nominal insulation thickness (100%): 5 kV: 90 mils., 8 kV: 115 mils., 15 kV: 175 mils., 25 kV: 260 mils. Nominal insulation thickness (133%): 15 kV: 220 mils.
- For cables manufactured to other specifications, confirm selection with cable and connector dimensions.
- For 25 kV, 35 kV, or an off-the-shelf 3/C splice alternative, select three appropriate single-conductor kits and one HVSA MOD kit.
- Kits do not contain connectors; order compression or solder connectors separately.
- If external grounding and/or shield interrupting is required, order an HVS-EG-3 kit.
- Standard package: 1 kit/box.
- Related test reports: 5/8 kV: EDR-5181, 15 kV: EDR-5114, 25-35 kV: EDR-5197

HVS-3/C Mod Rejacketing Kits For 3/C Shielded or Non-Shielded Cable

FEATURES

- The sealing mastic provides a secondary seal to protect against damage from water entering the splice region. Because just four sizes are able to rejacket a broad range of cable sizes from 5-35 kV, the HVS-3/C series kits allow complete inventory flexibility.

APPLICATIONS

- For use with three 1/C splice kits, each HVS-3/C kit contains all materials needed to convert three 1/C splices into one 3/C splice.

BENEFITS

- The MBSM wraparound sleeve provides environmental sealing, mechanical strength, and durability.
- HVS-3/C kits are off-the-shelf alternatives for rejacketing 3/C extruded dielectric (XLPE- or EPR-insulated) power cables.



PRODUCT SELECTION INFORMATION: DIMENSIONS IN INCHES (MM)

Catalog Number	3/C Splicing Using 3 of 1/C kits	Order This HVS-3/C kit	Splice Reference Dimensions			
			Conductor Size Range (AWG/kcmil)	Insulation Diameter	Kit Installed Length	Required Install Space
HVS-501		HVS-3/C-1	#6-#1	0.40-0.70 (10-18)	40 (1016)	48 (1219)
HVS-502		HVS-3/C-2	1/0-300	0.65-1.05 (17-27)	48 (1219)	56 (1422)
HVS-503		HVS-3/C-2	350-1000	0.95-1.65 (24-42)	48 (1219)	56 (1422)
HVS-821S	(5 kV)	HVS-3/C-1	#6-2/0	0.35-0.65 (9-17)	40 (1016)	48 (1219)
	(5/8 kV)	HVS-3/C-1	#6-2	0.35-0.65 (9-17)	40 (1016)	48 (1219)
HVS-822S	(5 kV)	HVS-3/C-2	3/0-300	0.55-0.90 (14-23)	48 (1219)	56 (1422)
	(5/8 kV)	HVS-3/C-2	#1-4/0	0.55-0.90 (14-23)	48 (1219)	56 (1422)
HVS-823S	(5 kV)	HVS-3/C-2	350-750	0.80-1.25 (20-32)	48 (1219)	56 (1422)
	(5/8 kV)	HVS-3/C-2	250-350	0.80-1.25 (20-32)	48 (1219)	56 (1422)
HVS-824S	(5 kV)	HVS-3/C-3	1000-1500	1.00-1.60 (25-41)	60 (1524)	68 (1727)
	(5/8 kV)	HVS-3/C-3	500-750	1.00-1.60 (25-41)	60 (1524)	68 (1727)
HVS-825S	(5/8 kV)	HVS-3/C-3	750-1000	1.30-2.25 (33-47)	60 (1524)	68 (1727)
HVS-1521S		HVS-3/C-3	#2-4/0	0.65-1.05 (17-27)	60 (1524)	68 (1727)
HVS-1522S		HVS-3/C-3	250-350	0.90-1.30 (23-33)	60 (1524)	68 (1727)
HVS-1523S		HVS-3/C-4	500-750	1.10-1.60 (28-41)	72 (1829)	80 (2032)
HVS-1524S		HVS-3/C-4	750-1000	1.25-1.80 (32-46)	72 (1829)	80 (2032)
HVS-2521S		HVS-3/C-4	#1-250	0.90-1.20 (23-31)	60 (1524)	68 (1727)
HVS-2522S		HVS-3/C-4	350-500	1.20-1.50 (31-38)	72 (1829)	80 (2032)
HVS-2523S		HVS-3/C-4	750-1000	1.50-1.80 (38-46)	72 (1829)	80 (2032)
HVS-3521S		HVS-3/C-4	1/0-3/0	0.95-1.35 (24-34)	72 (1829)	80 (2032)
HVS-3522S		HVS-3/C-4	4/0-600	1.20-1.70 (30-43)	72 (1829)	80 (2032)
HVS-3523S		HVS-3/C-4	600-1000	1.55-2.15 (39-55)	72 (1829)	80 (2032)
HVS-3524S		HVS-3/C-4	1250-2000	2.1-2.63 (53-66)	72 (1829)	80 (2032)

ADDITIONAL PRODUCT INFORMATION

- Select the appropriate HVS-3/C kit based on the three 1/C kits used for the application (see table above). One HVS-3/C kit will rejacket one 3/C splice. HVS-500 (5 kV) Non-shielded, HVS-820S (5/8 kV), HVS-1520S (15 kV), HVS-2520S (25 kV), HVS-3520S (35 kV)
- Selections are based on the typical dimensions of 100% insulated cables and commonly used connectors, manufactured in accordance with AEIC standard. Nominal conductor size range for the 1/C splice kits is based on the typical dimensions of 100% and 133% insulated cables.
- Minimum 3/C cable jacket O.D. HVS-3/C-1 [0.65" (17 mm)], HVS-3/C-2 [1.30" (33 mm)], HVS-3/C-3 [1.80" (46 mm)], HVS-3/C-4 [2.15" (55 mm)]
- Standard package: 1 kit/box

HVSA Mod Rearmoring and Rejacketing Kits 3/C Armored Cable (5-35 kV)

FEATURES

- An alternative 3/C armored splicing system that incorporates three 1/C splices, a wraparound interlocking steel armoring case, and a wraparound sealing sleeve.
- Select appropriate 1/C splice kits plus the applicable HVSA kit from the table below.

APPLICATIONS

- For Rearmoring and Rejacketing 3/C Armored Cable (5-35 kV)

BENEFITS

- ♦ HVSA mod kits are off-the-shelf alternatives for rejacketing 3/C armored cable splices.



PRODUCT SELECTION INFORMATION: DIMENSIONS IN INCHES (MM)

Catalog Number	3/C Splicing Using 3 of 1/C kits	Order This HVSA-MOD Kit	Splice Reference Dimensions			
			Conductor Size Range (AWG/kcmil)	Insulation Diameter	Kit Installed Length	Required Install Space
HVS-501		HVSA-1	#6-#1	0.40-0.70 (10-18)	48 (1219)	56 (1422)
HVS-502		HVSA-1	1/0-300	0.65-1.05 (17-27)	48 (1219)	56 (1422)
HVS-503		HVSA-2	350-1000	0.95-1.65 (24-42)	55 (1397)	63 (1600)
HVS-821S	(5 kV)	HVSA-1	#6-2/0	0.35-0.65 (9-17)	48 (1219)	56 (1422)
	(5/8 kV)	HVSA-1	#6-#2	0.35-0.65 (9-17)	48 (1219)	56 (1422)
HVS-822S	(5 kV)	HVSA-2	3/0-300	0.55-0.90 (14-23)	55 (1397)	63 (1600)
	(5/8 kV)	HVSA-2	#1-4/0	0.55-0.90 (14-23)	55 (1397)	63 (1600)
HVS-823S	(5 kV)	HVSA-2	350-750	0.80-1.25 (20-32)	55 (1397)	63 (1600)
	(5/8 kV)	HVSA-2	250-350	0.80-1.25 (20-32)	55 (1397)	63 (1600)
HVS-824S	(5 kV)	HVSA-3	1000-1500	1.00-1.60 (25-41)	72 (1829)	80 (2032)
	(5/8 kV)	HVSA-3	500-750	1.00-1.60 (25-41)	72 (1829)	80 (2032)
HVS-825S	(5/8 kV)	HVSA-3	750-1000	1.30-2.25 (33-57)	72 (1829)	80 (2032)
HVS-1521S		HVSA-3	#2-4/0	0.65-1.05 (17-27)	72 (1829)	80 (2032)
HVS-1522S		HVSA-3	250-350	0.90-1.30 (23-33)	72 (1829)	80 (2032)
HVS-1523S		HVSA-3	500-750	1.10-1.60 (28-41)	72 (1829)	80 (2032)
HVS-1524S		HVSA-3	750-1000	1.25-1.80 (32-46)	72 (1829)	80 (2032)
HVS-2521S		HVSA-3	#1-250	0.90-1.20 (23-30)	72 (1829)	80 (2032)
HVS-2522S		HVSA-3	350-500	1.20-1.50 (30-38)	72 (1829)	80 (2032)
HVS-2523S		HVSA-4	750-1000	1.50-1.80 (38-46)	81 (2057)	89 (2261)
HVS-3521S		HVSA-3	1/0-3/0	0.95-1.35 (24-34)	72 (1829)	80 (2032)
HVS-3522S		HVSA-4	4/0-600	1.20-1.70 (30-43)	81 (2057)	89 (2261)
HVS-3523S		HVSA-4	600-1000	1.55-2.15 (39-55)	81 (2057)	89 (2261)
HVS-3524S		HVSA-4	1250-2000	2.1-2.63 (53-66)	?	?

ADDITIONAL PRODUCT INFORMATION

- Select the appropriate HVS-3/C kit based on the three 1/C kits used for the application (see table above). One HVS-3/C kit will rejacket one 3/C splice. HVS-500 (5 kV) Non-shielded, HVS-820S (5/8 kV), HVS-1520S (15 kV), HVS-2520S (25 kV), HVS-3520S (35 kV)
- Selections are based on the typical dimensions of 100% insulated cables and commonly used connectors, manufactured in accordance with AEIC standard. Nominal conductor size range for the 1/C splice kits is based on the typical dimensions of 100% and 133% insulated cables.
- Minimum 3/C cable jacket O.D. HVS-3/C-1 0.65" (17 mm), HVS-3/C-2 1.30" (33 mm), HVS-3/C-3 1.80" (46 mm), HVS-3/C-4 2.15" (55 mm)
- Standard package: 1 kit/box

HVS/HVSR 1/C In-Line Transition and “Reducer” Kits (15-35 kV)

FEATURES

- TE's Raychem HVSR “reducer” kits are used as a transition splice when the PILC/VCLC conductor size is much smaller than that of the poly cable.
- Meets IEEE-404 standard requirements.

APPLICATIONS

- Use as an in-line splice for paper-insulated, lead-covered (PILC) cable or varnished cambric-insulated, lead-covered (VCLC) cable
- Can also be used as a transition splice—PILC/VCLC to poly (copper tape, lead sheath, wire shield, UniShield, or jacketed/unjacketed concentric neutral) cable.

BENEFITS

- PILC splices utilize a highly effective oil-stop system. The system helps to reduce installation and outage time by eliminating insulation stepping, hand taping, lead wiping, and compound filling.

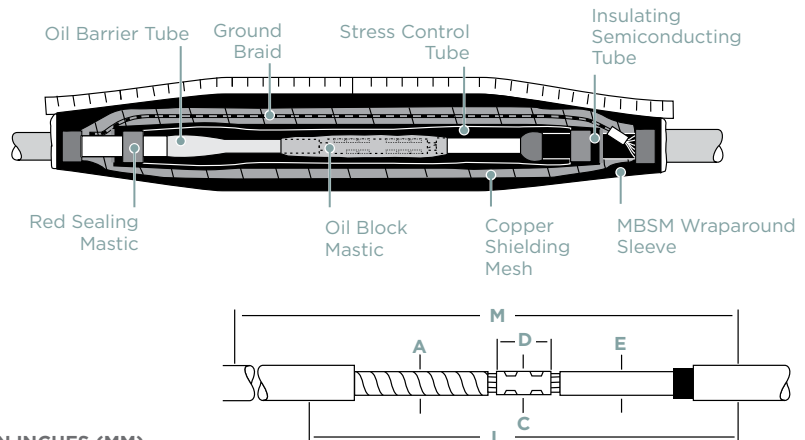

PRODUCT SELECTION INFORMATION: DIMENSIONS IN INCHES (MM)

Catalog Number	Conductor Size (AWG/kcmil)	Min - Max Insulation Diameter		Connector Dimensions (max)			Kit Installed Length (L)	Required Install Space (M)
		PILC (A)	POLY (E)	Both Cables O.D. (C)	PILC/PILC Length (D)	PILC/poly Length (D)		
HVS-1580D (15 kV)								
HVS-1581D	#4-4/0	0.60-0.90 (15-23)	0.65-1.05 (17-27)	0.90 (23)	3.5 (89)	4.5 (114)	31 (787)	48 (1219)
HVS-1582D	250-350	0.85-1.10 (22-28)	0.90-1.30 (23-33)	1.15 (29)	3.5 (89)	5.5 (140)	35 (889)	50 (1270)
HVS-1583D	500-750	1.05-1.30 (27-33)	1.10-1.60 (28-41)	1.60 (41)	5.0 (127)	7.0 (178)	37 (940)	50 (1270)
HVS-1584D	750-1000	1.15-1.50 (29-38)	1.25-1.80 (32-46)	1.85 (47)	6.0 (152)	8.0 (203)	40 (1016)	54 (1392)
HVS-2580E (25 kV)								
HVS-2582E	#1-250	0.85-1.20 (22-30)	0.90-1.25 (23-32)	1.10 (28)	3.5 (89)	4.5 (114)	40 (1016)	57 (1448)
HVS-2583E	350-500	1.15-1.45 (29-37)	1.15-1.50 (29-38)	1.35 (34)	5.0 (127)	8.0 (203)	40 (1016)	58 (1473)
HVS-2584E	750-1000	1.50-1.70 (38-43)	1.60-1.90 (41-48)	1.85 (47)	6.0 (152)	9.0 (229)	40 (1016)	61 (1549)
HVS-3580D (35 kV)								
HVS-3582D	1/0-250	1.05-1.40 (27-36)	1.05-1.40 (27-36)	1.20 (30)	3.5 (89)	5.5 (140)	40 (1016)	62 (1575)
HVS-3583D	300-750	1.20-1.70 (30-43)	1.30-1.75 (33-44)	1.60 (41)	6.0 (152)	9.0 (229)	48 (1219)	67 (1702)
HVS-3584D	750-1000	1.60-2.00 (41-51)	1.65-2.00 (41-51)	1.85 (47)	7.0 (178)	10.0 (254)	48 (1219)	67 (1702)
HVSR-1580 Transition Reducer (15 kV)								
HVSR-1582	#4-4/0/4/0-350	0.60-0.90 (15-23)	0.90-1.30 (23-33)	1.15 (29)		5.5 (140)	33 (838)	78 (1981)
HVSR-1583	4/0-350/500-750	0.80-1.10 (20-28)	1.10-1.60 (28-41)	1.60 (41)		7.0 (178)	37 (940)	87 (2210)
HVSR-1584	4/0-500/750-1000	0.80-1.20 (20-30)	1.25-1.80 (32-46)	1.85 (47)		8.0 (203)	40 (1016)	92 (2337)
HVSR-2580E Transition Reducer (25 kV)								
HVSR-2583E	#1-350/350-500	0.80-1.20 (20-30)	1.15-1.50 (29-38)	1.35 (34)		7.0 (178)	40 (1016)	58 (1473)
HVSR-2584E	500-750/750-1000	1.25-1.50 (32-38)	1.55-1.90 (39-48)	1.85 (47)		8.0 (203)	40 (1016)	61 (1549)

ADDITIONAL PRODUCT INFORMATION

- Select the appropriate catalog number. Selections are based on the typical dimensions of 100% and 133% insulated cables and commonly used connectors manufactured in accordance with AEIC standard. Nominal insulation thickness (100%): 15 kV: 165 mil (PILC/VCLC), 175 mils (poly). 25 kV: 255 mils (PILC/VCLC), 260 mils (poly). 28 kV: 255 mils (PILC/VCLC), 280 mils (poly). 35 kV: 330 mils (PILC VCLC), 345 mils (poly) Nominal insulation thickness (133%): 15 kV: 220 mils (poly).
- For cables manufactured to other specifications, confirm selection with cable and connector dimensions.
- Kits do not contain shear bolt connectors; order oil block (sweated or compression) connectors separately.
- Cable paper cutters are available. EXRM-1004
- For lead sheath repair, order an HVS-LR kit.
- Standard package: 1 kit/box
- Related test reports: 15 kV: EDR-5080, 25 kV: EDR-5083, 35 kV: EDR-5184



HVS-3-1590S/HVS-3-2590S 3/C In-line splices for PILC cable (15-25 kV)

FEATURES

- 3/C in-line PILC splices provide a highly effective and easily installed oil stop system, using standard heat-shrinkable components.
- Meets IEEE-404 standard requirements.

APPLICATIONS

- For use on 3/C paper-insulated, lead-covered (PILC) cable, or varnished cambric-insulated, lead covered (VCLC) cable.

BENEFITS

- The adhesive-lined conductive breakout provides an oil- and pressure-resistant seal and grounds the conductive tubing to the lead sheath.
- Oil barrier tubing locks the oil in the PILC cables, converting each conductor into the polymeric equivalent.

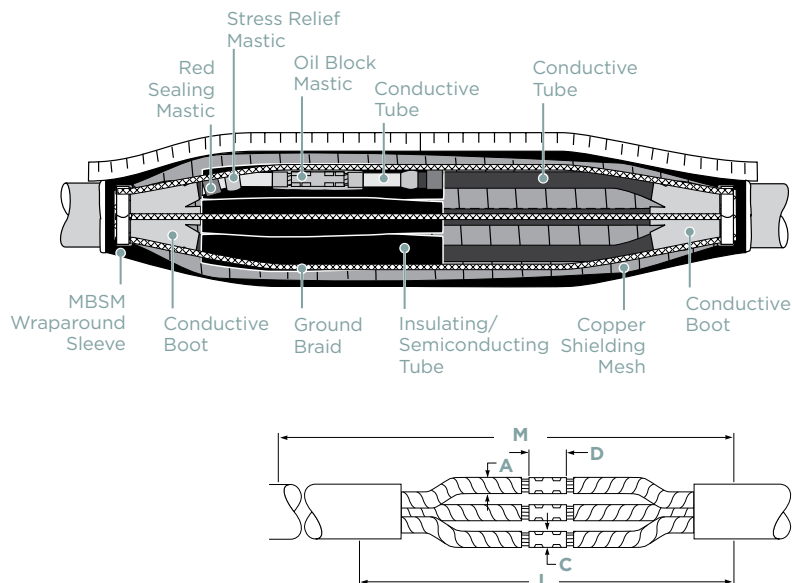

PRODUCT SELECTION INFORMATION: DIMENSIONS IN INCHES (MM)

Catalog Number	PILC Conductor Size (AWG/kcmil)	Min - Max PILC Insulation Dia. (A)	Connector Max O.D. (C)	Connector Max Length (D)	Kit Installed Length (L)	Required Install Space (M)
HVS-3-1590 (15 kV)						
HVS-3-1591	#4-4/0	0.60-1.00 (15-25)	0.90 (23)	3.5 (89)	63(1600)	67 (1702)
HVS-3-1592	250-350	0.85-1.10 (22-28)	1.15 (29)	3.5 (89)	63 (1600)	67 (1702)
HVS-3-1593	500-750	1.05-1.50 (27-38)	1.60 (41)	5.0 (127)	67 (1702)	71 (1803)
HVS-3-1594	750-1000	1.15-1.75 (29-44)	1.85 (47)	6.0 (152)	67 (1702)	71 (1803)
HVS-3-1590S "shorty" (15 kV)*						
HVS-3-1591S	#2-350	0.65-1.00 (17-25)	0.85 (22)	3.0 (76)	55 (1397)	55 (1397)
HVS-3-1592S	4/0-600	0.85-1.25 (22-32)	1.20 (30)	4.0 (102)	59 (1499)	59 (1499)
HVS-3-1593S	500-1000	1.00-1.50 (25-38)	1.50 (38)	5.0 (127)	59 (1499)	59 (1499)
HVS-3-2590E (25 kV)						
HVS-3-2591E	#1-350	0.85-1.15 (22-29)	1.15 (29)	4.0 (102)	67 (1702)	71 (1803)
HVS-3-2592E	350-750	1.10-1.50 (28-32)	1.40 (36)	5.0 (127)	67 (1702)	71 (1803)

HVS-3-1590S "shorty" splice kit does not allow cross phasing.

ADDITIONAL PRODUCT INFORMATION

- Select the appropriate catalog number. Selections are based on the typical dimensions of 100%-insulated cables (manufactured in accordance with the data contained in AEIC 1-1968 and commonly used connectors). Nominal insulation thickness (100%): 15 kV: 165 mils., 25 kV: 255 mils.
- For cables manufactured to other specifications, confirm selection with cable and connector dimensions.
- Kits do not contain connectors; order oil block (sweated or compression) connectors separately.
- Standard package: One 3/C kit/box.
- Related test reports: HVS-3-1590/2590: EDR-5143, HVS-3-1590S: EDR-5250, HVS-3-2590E: EDR-5223

HVS-T/HVSR-T 3/C PILC/VCLC to 1/C Poly Trifurcating Transition and Transition "Reducer" Kits (15-35 kV)

FEATURES

- Trifurcating transition splices greatly reduce the complexity of splicing one 3/C PILC cable to three 1/C polymeric cables.
- Provide solderless ground braid connection for PILC cable
- Meets IEEE-404 standard requirements.

APPLICATIONS

- Used for splicing 3/C PILC/VCLC to three individual poly cables
- Transition Reducer kits available for when the PILC/VCLC cable has a much smaller conductor size than the poly cable

BENEFITS

- By converting the PILC cable to a polymeric equivalent, the splices eliminate compound filling and difficult lead wiping which lets you get on and off the job site quickly.
- Heat shrink components help to eliminate lead sleeve failures by replacing lead sleeves and wipes that can crack due to corrosion or cable flexing.

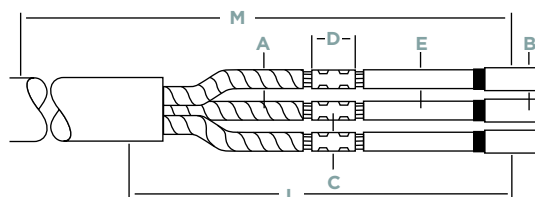
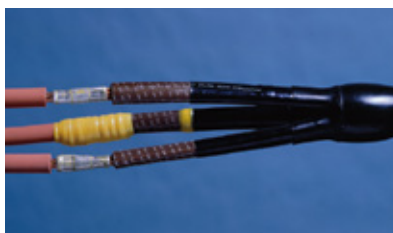

PRODUCT SELECTION INFORMATION: DIMENSIONS IN INCHES (MM)

Catalog Number	PILC/Poly Conductor Size (AWG/kcmil)	Min - Max Insulation Diameter		1/C Poly Jacket O.D. (B)	Connector Dimensions (max)		Kit Installed Length (L)	Required Install Space (M)
		PILC (A)	Poly (E)		O.D. (C)	Length (D)		
HVS-T-1580S (15 kV)								
HVS-T-1581S	#4-4/0*	0.60-1.00 (15-25)	0.65-1.05 (17-27)	1.35 (34)	0.90 (23)	4.5 (114)	40 (1016)	60 (1525)
HVS-T-1582S	250-350*	0.85-1.10 (22-28)	0.90-1.30 (23-33)	1.50 (38)	1.15 (29)	5.5 (140)	40 (1016)	62 (1575)
HVS-T-1583S	500-750*	1.05-1.50 (27-38)	1.10-1.60 (28-41)	1.90 (48)	1.60 (41)	7.0 (178)	48 (1219)	68 (1727)
HVS-T-1584S	750-1000	1.30-1.75 (33-44)	1.25-1.80 (32-46)	2.15 (55)	1.85 (47)	8.0 (203)	48 (1219)	69 (1753)
HVS-T-1580E-S (15 kV) Short Splice								
HVS-T-1581E-S	1/0-4/0*	0.65-1.00 (17-25)	0.70-1.05 (18-27)	1.40 (36)	0.90 (23)	2.5 (63)	40 (1016)	61 (1550)
HVS-T-1582E-S	250-500*	0.85-1.20 (22-30)	0.90-1.20 (23-30)	1.50 (38)	1.35 (34)	4.5 (114)	40 (1016)	65 (1650)
HVS-T-1583E-S	500-1000	1.10-1.50 (28-38)	1.15-1.75 (29-44)	2.20 (56)	1.85 (47)	5.0 (127)	40 (1016)	69 (1753)
HVS-T-2580E (25 kV)								
HVS-T-2582E	#1-250	0.85-1.20 (22-30)	0.90-1.25 (23-32)	1.55 (39)	1.10 (28)	5.5 (140)	48 (1219)	65 (1650)
HVS-T-2583E	350-500	1.15-1.40 (29-36)	1.15-1.50 (29-38)	2.00 (51)	1.35 (34)	7.0 (178)	48 (1219)	75 (1900)
HVS-T-2584E	750-1000	1.50-1.70 (38-43)	1.50-1.90 (38-48)	2.15 (55)	1.85 (47)	8.0 (203)	48 (1219)	77 (1955)
HVS-T-3580S (35 kV)								
HVS-T-3582S	1/0-350	1.05-1.40 (27-36)	1.05-1.50 (27-38)	1.90 (48)	1.20 (30)	6.5 (165)	55 (1397)	81 (2057)
HVS-T-3583S	250-750	1.20-1.70 (30-43)	1.30-1.75 (30-44)	2.10 (53)	1.80 (46)	8.0 (203)	55 (1397)	85 (2159)
HVSR-T-1580 Transition Reducer (15 kV)								
HVSR-T-1582	#4-4/0/4/0-350	0.60-1.00 (15-25)	0.90-1.30 (23-33)	1.50 (38)	1.15 (29)	5.5 (140)	40 (1016)	62 (1575)
HVSR-T-1583	4/0-350/500-750	0.80-1.20 (20-30)	1.10-1.60 (28-41)	1.90 (48)	1.60 (41)	7.0 (178)	48 (1219)	68 (1727)
HVSR-T-1584	250-500/750-1000	0.85-1.30 (22-33)	1.25-1.80 (32-46)	2.15 (55)	1.85 (47)	8.0 (203)	48 (1219)	69 (1753)
HVSR-T-2580E Transition Reducer (25 kV)								
HVSR-T-2582E	#1-400/350-500	0.80-1.20 (20-30)	1.15-1.50 (29-38)	2.00 (51)	1.35 (34)	7.0 (178)	48 (1219)	75 (1900)
HVSR-T-2583E	500-600/750-1000	1.25-1.40 (32-36)	1.55-1.90 (39-48)	2.15 (55)	1.85 (47)	8.0 (203)	48 (1219)	77 (1955)

* Check the jacket O.D. on the 133% insulated, single-conductor 15-kV 4/0, 350-kcmil, and 750-kcmil cables to ensure they fall within the use range specified. If you have any questions, contact your TE Connectivity field sales engineer or representative.

ADDITIONAL PRODUCT INFORMATION

- Select the appropriate catalog number. All selections are based on the typical dimensions of 100% and 133% insulated poly cables and commonly used connectors manufactured in accordance with AEIC standard. Nominal insulation thickness (100%): 15 kV: 165 mils (PILC/VCLC). 175 mils (poly)., 25 kV: 255 mils (PILC/VCLC). 260 mils (poly). 35 kV: 330 mils (PILC/VCLC). 345 mils (poly). Nominal insulation thickness (133%): 15 kV: 220 mils (poly).
- For cables manufactured to other specifications, confirm selection with cable and connector dimensions.
- Kits do not contain connectors; order oil block (sweated or compression) connectors separately.
- Standard package: 1 kit/box
- Related test reports: 15 kV: EDR-5137, 25 kV: EDR-5142, 35 kV: EDR-5184, 15 kV HVS-T-1580E-S: EDR-5227
- Cable paper cutters are available EXRM-1004.
- For a cold applied alternative, see CAT-J series

HVS-T-1590S 3/C PILC/VCLC to PILC/VCLC Trifurcating Kits (15 kV)

FEATURES

- Trifurcating transition splices greatly reduce the complexity of splicing one 3/C PILC cable to three 1/C PILC cables.
- This kit converts one 3/C (PILC/VCLC) cable to three 1/C (PILC/VCLC) cables
- Meets IEEE-404 standard requirements..

APPLICATIONS

- For use on paper-insulated, lead-covered (PILC) cable or varnished cambric-insulated, lead-covered (VCLC) cable.

BENEFITS

- ♦ By converting the PILC cable to a polymeric equivalent, the splices eliminate compound filling and difficult lead wiping which lets you get on and off the job site quickly.
- ♦ Heat-shrink components help to eliminate lead sleeve failures by replacing lead sleeves and wipes that can crack due to corrosion or cable flexing.

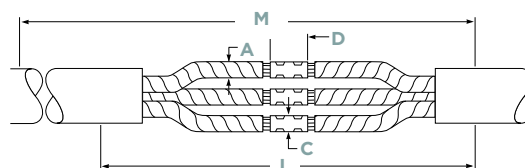
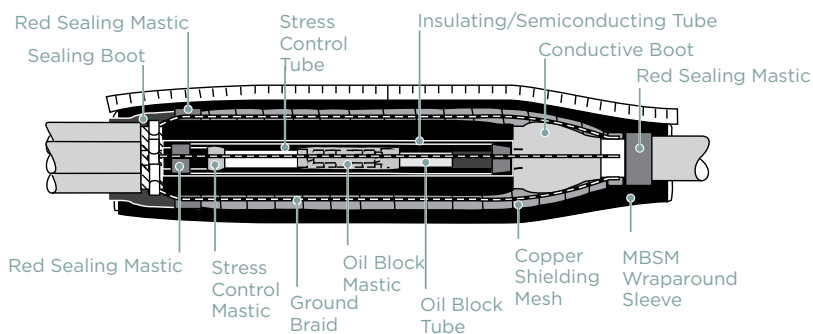

PRODUCT SELECTION INFORMATION: DIMENSIONS IN INCHES (MM)

Catalog Number	PILC Conductor Size (AWG/kcmil)	Min - Max PILC Insulation Dia. (A)	1/C PILC Jacket (Max O.D.) (B)	Connector Max O.D. (C)	Connector Max Length (D)	Kit Installed Length (L)	Required Install Space (M)
HVS-T-1590S (15 kV)							
HVS-T-1591S	#4-4/0	0.60-1.05 (15-27)	1.30 (33)	0.90 (23)	3.5 (89)	40 (1016)	60 (1524)
HVS-T-1592S	4/0-400	0.85-1.30 (22-33)	1.50 (38)	1.15 (29)	4.5 (114)	40 (1016)	60 (1524)
HVS-T-1593S	500-750	1.05-1.60 (27-40)	1.90 (48)	1.60 (41)	6.0 (152)	48 (1219)	64 (1626)

ADDITIONAL PRODUCT INFORMATION

- Select the appropriate catalog number. All selections are based on the typical dimensions of 100% insulated cables and dimensions of commonly used connectors manufactured in accordance with AEIC standard. Nominal insulation thickness (100%): 165 mils.
- Kits do not contain connectors; order oil block (sweated or compression) connectors separately.
- Standard package: 1 kit/box
- Related test reports: EDR-5143
- Cable paper cutters are available EXRM-1004.

HVS/HVSA-3-1580S (Unarmored & Armored) Kits (15 kV)

FEATURES

- Incorporates a thermoplastic internal moisture sealant as a secondary barrier. Load cycle tested to perform at a conductor temperature of 110°C with an internal oil pressure of 15 psi.
- Meets IEEE-404 standard requirements.

APPLICATIONS

- Provide a reliable means for splicing 3/C 15 kV PILC/VCLC cables to 3/C 15 kV armored or unarmored polymeric cables.

BENEFITS

- Eliminates the need for compound filling, lead wiping and hot oil. Installation is quick, easy, and repeatable.
- TE utilizes high temperature oil barrier tubing, oil-block mastic, and a high-density conductive boot to seal the oil within the PILC cable. This oil sealing technology has been successful in over 18 years of installations. Heat-shrink accessories fit out-of-round and sectored cables, and handle conductor size transitions.
- TE utilizes its rugged MBSM re-jacketing sleeve to seal against moisture ingress.

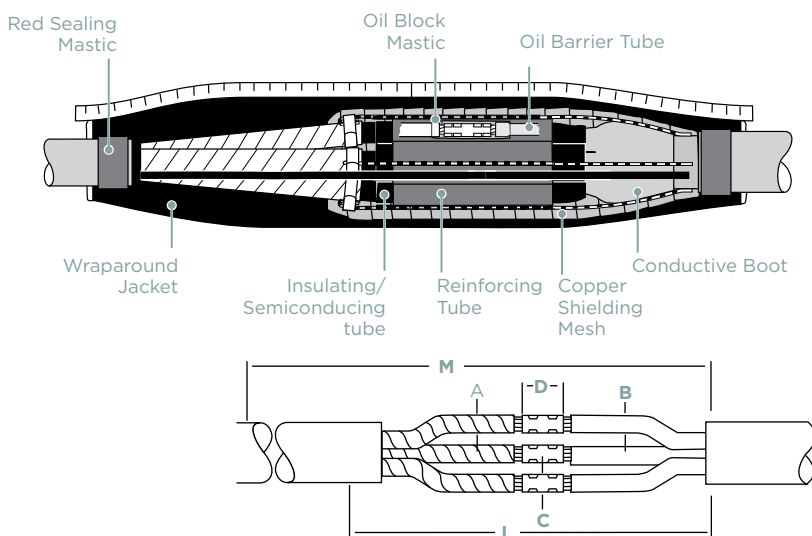
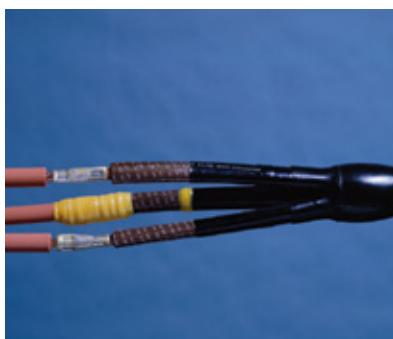

PRODUCT SELECTION INFORMATION: DIMENSIONS IN INCHES (MM)

Catalog Number	PILC/Poly Conductor Size (AWG/kcmil)	Min - Max PILC Insulation Dia (A)	Min - Max Poly Insulation Dia (B)	Connector Max O.D. (C)	Connector Max Length (D)	Kit Installed Length (L)	Required Install Space (M)
HVS-3-1580S Unarmored Cable (15 kV)							
HVS-3-1581S	#4-4/0	0.60-1.00 (15-25)	0.60-1.05 (17-27)	1.15 (29)	5.5 (140)	60 (1524)	68 (1727)
HVS-3-1582S	250-350	0.85-1.10 (22-28)	0.90-1.30 (23-33)	1.15 (29)	5.5 (140)	60 (1524)	68 (1727)
HVS-3-1583S	500-750	1.05-1.50 (27-38)	1.10-1.60 (28-41)	1.60 (41)	7.0 (178)	72 (1829)	80 (2032)
HVS-3-1584S	750-1000	1.15-1.75 (29-44)	1.25-1.80 (32-46)	1.85 (47)	8.0 (203)	72 (1829)	80 (2032)
HVSA-3-1580S Armored Cable (15 kV)							
HVSA-3-1581S	#4-4/0	0.65-1.00 (17-25)	0.60-1.05 (17-27)	0.90 (23)	4.50 (114)	63 (1600)	70 (1778)
HVSA-3-1582S	250-350	0.85-1.10 (22-28)	0.90-1.30 (23-33)	1.15 (29)	5.5 (140)	72 (1829)	80 (2032)
HVSA-3-1583S	500-750	1.05-1.50 (27-38)	1.10-1.60 (28-41)	1.60 (41)	7.0 (178)	72 (1829)	80 (2032)
HVSA-3-1584S	750-1000	1.15-1.75 (29-44)	1.25-1.85 (32-46)	1.85 (47)	8.0 (203)	72 (1829)	80 (2032)

ADDITIONAL PRODUCT INFORMATION

- Select the appropriate catalog number. All selections are based on the typical dimensions of 100% insulated cables and the dimensions of commonly used connectors manufactured in accordance with AEIC standard. Nominal insulation thickness (100%): 165 mils.
- Armored kits include an interlocking steel armoring wraparound with bendable fingers to provide a smooth transition to the armor.
- Kits do not contain connectors; order oil block (sweated or compression) connectors separately.
- These kits do not allow cross-phasing.
- Standard package: 1 kit/box
- Related test reports: EDR-5137
- Cable paper cutters are available EXRM-1004.

HVSY Wye (Tap) Splices for 1/C Poly-Poly, PILC-PILC, & PILC-Poly Cable (15 kV)

FEATURES

- Includes a positive heat-activated sealant system that eliminates taping between main and tap cables.
- Designed to seal against moisture ingress by including a branch clip and the heavy-duty MBSM wraparound sleeve
- Meets IEEE-404 standard requirements.

APPLICATIONS

- HVSY-1520S is for use on copper tape, wire shield, lead sheath, and UniShield cables.
- HVSY-1580D is for use as a Wye splice where the main and/or tap cables may be paper-insulated, lead-covered (PILC) cable; varnished cambric-insulated, or lead-covered (VCLC) cable.
- Used for submersible or direct burial.

BENEFITS

- Excellent water barrier. Internal moisture seal for redundancy
- Splices accept a wide range of main and tap cable sizes
- Compact shape simplifies cable training

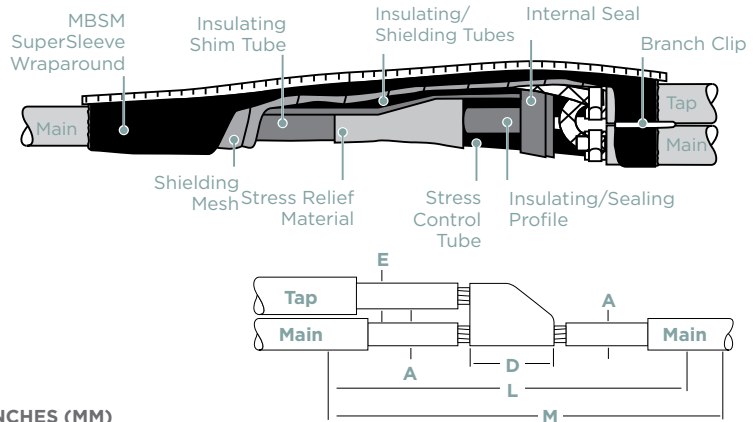
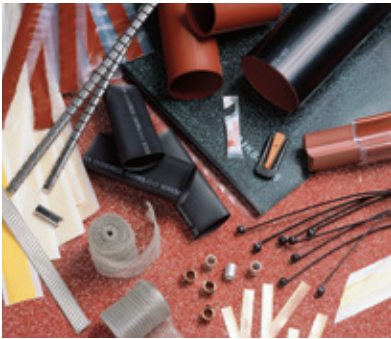

PRODUCT SELECTION INFORMATION: DIMENSIONS IN INCHES (MM)

Catalog Number	Poly Conductor Size (AWG/kcmil)		Min - Max Insulation Diameter		Max Connector Length (max) (D)	Kit Installed Length (L)	Required Installation Space (M)	Burdny Connector
	Main	Tap	Main (A)	Tap (E)				
HVSY-1520S (15 kV Polymeric Wye) For use with soldered connectors.								
HVSY-1522S	#2-4/0	#2-4/0	0.65-1.05 (17-27)	0.65-1.05 (17-27)	3.0 (75)	30 (750)	45 (1125)	
HVSY-1523S	250-750	#2-750	0.95-1.45 (24-37)	0.65-1.45 (17-37)	3.5 (90)	30 (750)	45 (1125)	
HVSY-1520S (15 kV Polymeric Wye) For use with Burdny YSH crimp connectors for Copper conductors only								
HVSY-1522S	#2-4/0	#2-4/0	0.65-1.05 (17-27)	0.65-1.05 (17-27)	3.0 (75)	30 (750)	45 (1125)	YSH-2929
HVSY-1523S	250-500	4/0-500	0.85-1.25 (22-32)	0.85-1.25 (22-32)	3.5 (90)	30 (750)	45 (1125)	YSH-3434
HVSY-1524S	500-750	350-750	1.10-1.45 (28-37)	1.00-1.45 (25-37)	3.5 (90)	30 (750)	45 (1125)	YSH-3939

Catalog Number	PILC/Poly Conductor Size (AWG/kcmil)		Min - Max PILC/Poly Insulation Dia.		Lead Sheath (OD max)	Max Connector Length (D)	Kit Installed Length (L)	Required Install Space (M)
	Main	Tap	Main (A)	Tap (E)				
HVSY-1580D (15 kV PILC and PILC-Poly Wye)								
HVSY-1582D	#2-4/0	#2-4/0	0.65-1.05 (17-27)	0.65-1.05 (17-27)	1.20 (30)	3.0 (75)	30 (750)	45 (1125)
HVSY-1583D	250-750	#2-750	0.95-1.45 (24-37)	0.65-1.45 (17-37)	1.50 (38)	3.5 (90)	30 (750)	45 (1125)

ADDITIONAL PRODUCT INFORMATION

- Select the appropriate catalog number. All selections are based on the typical dimensions of 100% and 133% insulated cables and dimensions of commonly used connectors manufactured in accordance with AEIC standard. Nominal insulation thickness (100%): 165 mils (PILC/VCLC) 175 mils (poly) Nominal insulation thickness (133%): 220 mils (poly).
- For cables manufactured to other specifications, confirm selection with cable and connector dimensions.
- Kits do not contain connectors. For connector information contact your local TE sales representative for information. For HVSY-1520S kits with copper conductors only, H-tap compressed connectors, available from Burdny (800-346-4175), may be used in place of the half-duplex connector.
- Check poly cable insulation diameter to help ensure a proper fit.
- For 15 kV H-configuration connections on 1/C shielded power cable, order the HVSH-1520 mod kit for use in conjunction with appropriate HVSY-1520S kit.
- Standard package: 1 kit/box
- Related test reports: HVSY-1520S: EDR-5236, EDR-5238, HVSY-5256 HVSY-1580D: EDR-2535, EDR-5317

HVSH-MOD H Configuration Kits for 1/C Shielded Power Cable (15 kV)

FEATURES

- These splices can be used for submersible or direct burial applications.
- Meets IEEE-404 standard requirements.

APPLICATIONS

- Used in conjunction with HVSY-1520S and HVSY-1580D-MOD series Wye splice kits.

BENEFITS

- ♦ This combination provides a heat shrinkable 15 kV system that accommodates “H-configuration” connections for single-conductor power cables. This kit will accommodate both crimped connectors (copper conductor only) and soldered connectors.



PRODUCT SELECTION INFORMATION: DIMENSIONS IN INCHES (MM)

Catalog Number	Conductor Size (AWG/kcmil)		Min - Max Insulation Diameter		Connector Length (max)	Kit Installed Length	Kit Installed Space
	Main	Tap	Main	Tap			
HVSH-1520-MOD							
HVSY-1522S	#2-4/0	#2-4/0	0.65-1.05 (17-27)	0.65-1.05 (17-27)	3.0 (75)	30 (750)	45 (1125)
HVSH-1522-MOD							
HVSY-1523S	250-750	#2-750	0.95-1.45 (24-37)	0.65-1.45 (17-37)	3.5 (90)	30 (750)	45 (1125)
HVSH-1523-MOD							
HVSH-1580-MOD							
HVSY-1582D	#2-4/0	#2-4/0	0.65-1.05 (17-27)	0.65-1.05 (17-27)	3.0 (75)	30 (750)	45 (1125)
HVSH-1582D-MOD							
HVSY-1583D	250-750	#2-750**	0.85-1.45 (22-37)	0.65-1.45 (17-37)	3.5 (90)	30 (750)	45 (1125)
HVSH-1583D-MOD							

*To make an “H-configuration”, order both the standard HVSY kit and the HVSH-MOD kit.

**Check cable insulation diameter to ensure proper fit.

ADDITIONAL PRODUCT INFORMATION

- Poly cable selections are based on the typical dimensions of 100% insulated cables made in accordance with AEIC standard. Final kit selection should be verified by actual cable dimensions. PILC/VCLC cable selections are based on the typical dimensions of 100% insulated cables manufactured in accordance with AEIC standard.
- Kits do not contain connectors. For connector information contact your local TE sales representative for information.
- Standard package: 1 kit/box
- Related test reports HVSH-1520-MOD: EDR-5236, HVSH-1580D-MOD: EDR-5235

HVES Live End Seal for 1/C PILC and Poly or 3/C PILC Cable (15-25 kV)

FEATURES

- The outer adhesive-lined re-jacketing sleeve is designed to provide a positive environmental seal.
- These kits consist of heat shrinkable tubings and a high-dielectric strength, polymeric plug which overlap the conductor to provide excellent insulation.



APPLICATIONS

- Insulate and seal the ends of polymeric and PILC cables

BENEFITS

- ♦ Once TE's Raychem HVES kit is installed, the cable can be re-energized. Typical applications include the live ending of spare cables for future use, isolating a failed cable length, and sectionalizing a cable circuit during system maintenance and repair, expansion, or testing.

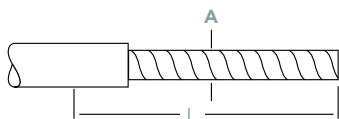

PRODUCT SELECTION INFORMATION: DIMENSIONS IN INCHES (MM)

Catalog Number	PILC/Poly Conductor Size (AWG/kcmil)	Min - Max Insulation Dia. PILC (A)	Min - Max Insulation Dia. Poly (A)	Kit Installed Length (L)
HVES-1520D (1/C PILC/VCLC and 1/C Poly) 15 kV				
HVES-1521D	#4-4/0	0.60-0.90 (15-23)	0.65-1.05 (17-27)	12 (305)
HVES-1522D	250-350	0.85-1.10 (22-28)	0.90-1.30 (23-33)	12 (305)
HVES-1523D	500-750	1.05-1.30 (27-33)	1.10-1.60 (28-41)	12 (305)
HVES-1524D	750-1000	1.20-1.50 (30-38)	1.25-1.80 (32-46)	12 (305)
HVES-2520D (1/C PILC/VCLC and 1/C Poly) 25 kV				
HVES-2521D	#1-250	0.85-1.25 (22-32)	0.85-1.25 (22-32)	21 (533)
HVES-2522D	350-500	1.15-1.50 (29-38)	1.15-1.50 (29-38)	23 (584)
HVES-2523D	750-1000	1.50-1.90 (38-48)	1.50-1.90 (38-48)	25 (635)

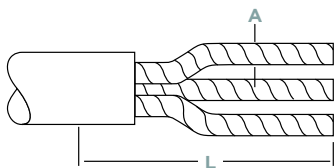

Catalog Number	PILC/Poly Conductor Size (AWG/kcmil)	Min - Max Insulation Dia. PILC (A)	Kit Installed Length (L)
HVES-3-1590 (3/C PILC/VCLC) 15 kV			
HVES-3-1591	#4-4/0	0.60-1.00 (15-25)	27 (686)
HVES-3-1592	250-350	0.85-1.10 (22-28)	27 (686)
HVES-3-1593	500-750	1.05-1.50 (27-38)	27 (686)
HVES-3-1594	750-1000	1.15-1.75 (29-44)	27 (686)
HVES-3-2590E (3/C PILC/VCLC) 25kV			
HVES-3-2591E	#1-250	0.85-1.20 (22-30)	28 (711)
HVES-3-2592E	350-500	1.15-1.40 (28-36)	31 (787)
HVES-3-2593E	750-1000	1.50-1.70 (38-43)	32 (813)

ADDITIONAL PRODUCT INFORMATION

- Select the appropriate catalog number. All selections are based on the typical dimensions of 100% insulated and 133% insulated poly cables manufactured in accordance with AEIC standard. Nominal insulation thickness (100%): 15 kV: 165 mils (PILC/VCLC), 175 mils (poly). 25 kV: 225 mils (PILC/VCLC), 260 mils (poly). Nominal insulation thickness (133%): 15 kV: 220 mils (poly).
- For cables manufactured to other specifications, confirm selection with cable dimensions.
- Standard package:
HVES-1520D,-2520D = One kit/box, HVES-3-1590,-2590E = One 3/C kit/box
- Related test reports: 15 kV: EDR-5146, 25 kV: EDR-5273

HV-MSK Splices for In-Line and Multiconductor/Medium-Voltage Multi-Conductor Mining Cable (5-8 kV)

FEATURES

- TE's Raychem HV-MSK is flame-retardant, multiconductor splice kits
- MSHA approved for 07-LA090013-MSHA

APPLICATIONS

- For use on standard flexible cables and mining cables (MP-GC and SHD-GC) up to 8 kV

BENEFITS

- Stepped connector design allows for longer life in higher use bending areas

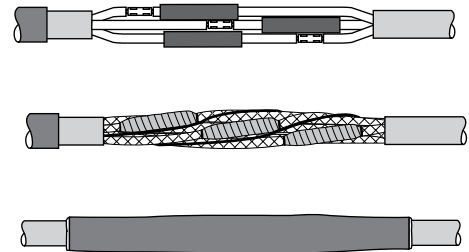

PRODUCT SELECTION INFORMATION: DIMENSIONS IN INCHES (MM)

Catalog Number	Power Conductor Size (AWG/kcmil)				Sleeve Length
	5 kV 3/C MP-GC	5 kV 3/C SHD-GC	8 kV 3/C MP-GC	8 kV 3/C SHD-GC	
HV-MSK for 3/C Flexible Cable (5-8 kV)					
HV-MSK-3/C-581	#6-#1	#6-#4	#6-#4		22
HV-MSK-3/C-582	1/0-350	#2-3/0	#2-4/0	#4-2/0	22
HV-MSK-3/C-584	400-750	4/0-350	250-750	3/0-350	29

ADDITIONAL PRODUCT INFORMATION

- Select appropriate catalog number based on conductor size for your cable type. Confirm selection with cable diameter range.
- Kits do not contain connectors; please order separately.
- For cable types not listed in this catalog, contact your local TE representative.
- Standard package: One 3/C kit per box.

3/C CSJA Cold Shrinkable Joint for 15 kV 3/C TECK Cables

FEATURES

- The joint consists of three pre-expanded silicone bodies on a unique holdout and a separate re-jacketing system.
- Single piece silicone rubber body for wide application range.
- Integrated electrical stress control via factory molded stress cones and a Faraday cage.
- TE Raychem CSJA joints have been qualified to IEEE-404.
- Easy release spiral holdout.

APPLICATIONS

- For 15 kV 3/C TECK cables

BENEFITS

- This design is easy to install with minimal steps and a short installation time.
- The cold applied wraparound GMRS re-jacketing system is designed to seal the entire splice and provide mechanical and environmental protection for direct buried and submersible installations.
- Both mechanical and compression connectors can be used.
- Robust re-jacketing solution eliminates parking distance



PRODUCT SELECTION INFORMATION: DIMENSIONS IN INCHES (MM)

Catalog Number	Voltage Class	Nominal Cable Range	Min - Max Insulation O.D. (A)	Connector Dimensions		Kit Installed Length (L)	Required Install Space (M)
				Max O.D. (C)	Max Length (D)		
CSJA 3/C No Connector, For TECK Cable							
CSJA-3-1521-TECK	15 kV	#2-350	0.69-1.20 (17.5-30.5)	1.30 (33.0)	5.50 (140.0)	65 (1650)	65 (1650)
CSJA-3-1522-TECK	15 kV	4/0-750	0.87-1.40 (22.1-35.6)	1.50 (38.0)	5.50 (140.0)	65 (1650)	65 (1650)
CSJA-3-1523-TECK	15 kV	350-1000	1.03-1.58 (26.2-40.0)	1.65 (42.0)	6.69 (170.0)	71 (1800)	71 (1800)

Catalog Number	Voltage Class	Nominal Cable Range	Min - Max Insulation O.D. (A)	Dia. Over Cable Conductor* min/max	Kit Installed Length	Required Install Space (M)
CSJA 3/C Copper Shear Bolt Connector, For TECK Cable						
CSJA-3-1521M1-TECK	15 kV	2/0-350	0.69-1.20 (17.5-30.5)	0.376-0.736 (9.5-18.7)	65 (1650)	65 (1650)
CSJA-3-1522M1-TECK	15 kV	4/0-500	0.87-1.40 (22.1-35.6)	0.376-0.736 (9.5-18.7)	65 (1650)	65 (1650)
CSJA-3-1522M2-TECK	15 kV	350-750	0.87-1.40 (22.1-35.6)	0.570-0.945 (14.5-24.0)	71 (1800)	71 (1800)
CSJA-3-1523M3-TECK	15 kV	500-1000	1.03-1.58 (26.2-40.0)	0.736-1.152 (18.7-29.3)	71 (1800)	71 (1800)
CSJA 3/C Aluminum Shear Bolt Connector, For TECK Cable						
CSJA-3-1521M4-TECK	15 kV	#2-3/0	0.69-1.20 (17.5-30.5)	0.268-0.470 (6.8-11.9)	65 (1650)	65 (1650)
CSJA-3-1521M5-TECK	15 kV	#2-350	0.69-1.20 (17.5-30.5)	0.268-0.681 (6.8-17.3)	65 (1650)	65 (1650)
CSJA-3-1522M6-TECK	15 kV	4/0-500	0.87-1.40 (22.1-35.6)	0.423-0.813 (10.7-20.6)	71 (1800)	71 (1800)
CSJA-3-1522M7-TECK	15 kV	500-750	0.87-1.40 (22.1-35.6)	0.736-0.998 (18.7-25.3)	71 (1800)	71 (1800)
CSJA-3-1523M8-TECK	15 kV	350-750	1.03-1.58 (26.2-40.0)	0.616-0.998 (15.7-25.3)	71 (1800)	71 (1800)

* Diameter Over Cable Conductor Min-Max accepted by the Al or Cu Shear Bolt Connector

ADDITIONAL PRODUCT INFORMATION

- Selections are based on the typical dimensions of 100% insulated cables, manufactured in accordance with AEIC standard. Nominal insulation thickness (100%): 15 kV: 175mils, 25 kV: 260mils, 35 kV: 345mils.
- Select the appropriate catalog number. Use the insulation OD and jacket OD range as the final ordering criteria.
- For mechanical shear bolt connector included in the kit confirm the correct connector selection according to the min/max diameter over the cable conductor from the tables.
- Standard package: 1 kit/box.
- Related test reports: EDR-5530.

CSJA In-line Cold Shrinkable Joints for all 1/C Shielded Power Cables

FEATURES

- Total length of the splice body on the holdout is 14 to 19 inches providing a compact design.
- Integrated electrical stress control enhanced by factory molded stress cones and a Faraday cage.
- Void filling stress relief mastics are not necessary.
- Proven shield continuity concept which can also bridge concentric neutrals.
- The joint accepts both mechanical and compression connectors.
- When a shear bolt connector is used, this is a totally crimpless system.
- Meets IEEE-404 standard requirements.

APPLICATIONS

- "All-in-One" cold shrinkable joint for 5 kV through 35 kV. It is designed to splice tape shield, wire shield, LC shield, UniShield, JCN and flat strap shielded cables.

BENEFITS

- ♦ This cable joint has a pre-expanded EPDM re-jacketing sleeve and an integrated neutral sock. The "All-in-One" design is easy to install with minimal steps and short installation time.
- ♦ A pre-expanded, single-piece silicone rubber joint body with high mechanical expansion capability allows a wide application range.
- ♦ The silicone rubber body provides high dielectric strength, high tear strength, low tension set, and excellent low temperature recovery.
- ♦ An ergonomically designed spiral holdout provides a smooth installation with low release forces.



4

PRODUCT SELECTION INFORMATION: DIMENSIONS IN INCHES (MM)

Catalog Number	Length of Moisture Blocked Braid (mm)	Braid (AWG)
Cold Applied External Grounding Kit		
CSJ-EG-1	24 (610)	#8
CSJ-EG-2	24 (610)	#6
CSJ-EG-3	24 (610)	#4
CSJ-EG-4	24 (610)	#2

ADDITIONAL PRODUCT INFORMATION

- Selections are based on the typical dimensions of 100% insulated cables, manufactured in accordance with AEIC standard. Nominal insulation thickness (100%): 15 kV: 175 mils, 25 kV: 260 mils, 35 kV: 345 mils.
- Select the appropriate catalog number. Use the insulation OD and jacket OD range as the final ordering criteria.
- For mechanical shear bolt connector included in the kit confirm the correct connector selection according to the Min/Max diameter over the cable conductor from the tables.
- If external grounding is required, order the CSJ-EG kit.
- Standard package: 1 kit per box.
- Related test reports: EDR-5430, EDR-5455, EDR-5513, EDR-5570, EDR-5572, EDR-5588
- For AL Mechanical shear bolt connector information request data sheet 9-1773440-4 and for CU request 165972.

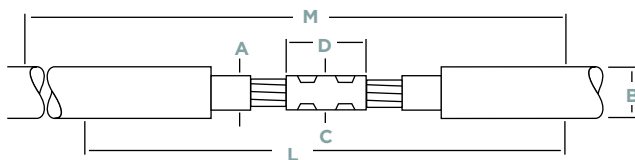
PRODUCT SELECTION INFORMATION: DIMENSIONS IN INCHES (MM)

Catalog Number	Voltage Class	Nominal Cable Range	Min - Max Insulation O.D. (A)	Jacket O.D. (max) (B)	Neutral Sock (AWG)	Min - Max Diameter Over Cable Conductor*		Kit Installed Length (L)	Required Install Space (M)
						O.D. (C)	Length (D)		
CSJA Joint Without Connector									
CSJA-821	5-8 kV	4/0-750	0.69-1.20 (17.5-30.5)	1.50 (38.1)	1/0	1.30 (33.0)	5.50 (140.0)	29 (737)	39 (990)
CSJA-1521	15 kV	#2-350	0.69-1.20 (17.5-30.5)	1.50 (38.1)	1/0	1.30 (33.0)	5.50 (140.0)	29 (737)	39 (990)
CSJA-1522	15 kV	4/0-750	0.87-1.40 (22.1-35.6)	1.80 (46.0)	1/0	1.50 (38.0)	5.50 (140.0)	29 (737)	39 (990)
CSJA-1523	15 kV	350-1000	1.03-1.58 (26.2-40.0)	2.05 (52.1)	2/0	1.65 (42.0)	6.69 (170.0)	33 (838)	43 (1090)
CSJA-1524	15 kV	750-1250	1.28-2.05 (32.50-52.0)	2.60 (66.0)	2/0	1.85 (47.0)	7.90 (200.0)	37 (939)	49 (1244)
CSJA-2822	28 kV	#1-500	0.87-1.40 (22.1-35.6)	1.80 (46.0)	1/0	1.50 (38.0)	5.50 (140.0)	29 (737)	39 (990)
CSJA-2823	28 kV	4/0-750	1.03-1.58 (26.20-40.0)	2.05 (52.1)	2/0	1.65 (42.0)	6.69 (170.0)	33 (838)	43 (1090)
CSJA-2824	28 kV	500-1250	1.28-2.05 (32.50-52.0)	2.60 (66.0)	2/0	1.85 (47.0)	7.90 (200.0)	37 (939)	49 (1244)
CSJA-3523	35 kV	1/0-350	1.03-1.49 (26.20-37.8)	2.05 (52.1)	2/0	1.40 (35.6)	5.50 (140.0)	33 (838)	43 (1090)
CSJA-3524	35 kV	350-1000	1.28-2.05 (34.54-52.0)	2.60 (66.0)	2/0	1.96 (50.0)	7.90 (200.0)	37 (939)	49 (1244)
CSJA-3525	35 kV	750-1250	1.63-2.36 (41.40-60.0)	2.60 (66.0)	2/0	2.36 (60.0)	7.90 (200.0)	37 (939)	49 (1244)
CSJA Joint With Copper Mechanical Shear Bolt Connector									
CSJA-1521M1	15 kV	2/0-350	0.69-1.20 (17.5-30.5)	1.50 (38.1)	1/0	0.376-0.736 (9.50-18.7)		29 (737)	39 (990)
CSJA-1522M1	15 kV	4/0-500	0.87-1.40 (22.1-35.6)	1.80 (46.0)	1/0	0.376-0.736 (9.50-18.7)		29 (737)	39 (990)
CSJA-1522M2	15 kV	350-750	0.87-1.40 (22.1-35.6)	1.80 (46.0)	1/0	0.570-0.945 (14.5-24.0)		29 (737)	39 (990)
CSJA-1523M2	15 kV	350-750	1.03-1.58 (26.2-40.0)	2.05 (52.1)	2/0	0.570-0.945 (14.5-24.0)		33 (838)	43 (1090)
CSJA-2822M1	28 kV	2/0-500	0.87-1.40 (22.1-35.6)	1.80 (46.0)	1/0	0.376-0.736 (9.50-18.7)		29 (737)	39 (990)
CSJA-2823M2	28 kV	350-750	1.03-1.58 (26.2-40.0)	2.05 (52.1)	2/0	0.570-0.945 (14.5-24.0)		33 (838)	43 (1090)
CSJA-2824M2	28 kV	500-750	1.28-2.05 (32.50-52.0)	2.60 (66.0)	2/0	0.570-0.945 (14.5-24.0)		37 (939)	49 (1244)
CSJA-3523M1	35 kV	2/0-350	1.03-1.49 (26.20-37.8)	2.05 (52.1)	2/0	0.376-0.736 (9.50-18.7)		33 (838)	43 (1090)
CSJA-3524M2	35 kV	350-750	1.28-2.05 (34.54-52.0)	2.60 (66.0)	2/0	0.570-0.945 (14.5-24.0)		37 (939)	49 (1244)
* Min./max. diameter over cable conductor accepted by the copper mechanical connector.									
CSJA Joint with Aluminum Mechanical Shear Bolt Connector									
CSJA-1521M4	15 kV	#2-3/0	0.69-1.20 (17.5-30.5)	1.50 (38.1)	1/0	0.268-0.470 (6.80-11.9)		29 (737)	39 (990)
CSJA-1521M5	15 kV	#2-350	0.69-1.20 (17.5-30.5)	1.50 (38.1)	1/0	0.268-0.681 (6.80-17.3)		29 (737)	39 (990)
CSJA-1522M6	15 kV	350-750	0.87-1.40 (22.1-35.6)	1.80 (46.0)	1/0	0.423-0.813 (10.7-20.6)		29 (737)	39 (990)
CSJA-1522M7	15 kV	350-750	0.87-1.40 (22.1-35.6)	1.80 (46.0)	1/0	0.736-0.998 (18.7-25.3)		29 (737)	39 (990)
CSJA-1523M8	15 kV	350-750	1.03-1.58 (26.20-40.0)	2.05 (52.1)	2/0	0.616-0.998 (15.7-25.3)		33 (838)	43 (1090)
CSJA-1524M9	15 kV	750-1000	1.28-2.05 (32.50-52.0)	2.60 (66.0)	2/0	0.813-1.152 (20.6-29.2)		37 (939)	49 (1244)
CSJA-2822M5	28 kV	#1-350	0.87-1.40 (22.1-35.6)	1.80 (46.0)	1/0	0.268-0.681 (6.80-17.3)		29 (737)	39 (990)
CSJA-2822M6	28 kV	4/0-500	0.87-1.40 (22.1-35.6)	1.80 (46.0)	1/0	0.423-0.813 (10.7-20.6)		29 (737)	39 (990)
CSJA-2823M8	28 kV	350-750	1.03-1.58 (26.20-40.0)	2.05 (52.1)	2/0	0.616-0.998 (15.7-25.3)		33 (838)	43 (1090)
CSJA-2824M8	28 kV	500-750	1.28-2.05 (32.50-52.0)	2.60 (66.0)	2/0	0.616-0.998 (15.7-25.3)		37 (939)	49 (1244)
CSJA-2824M9	28 kV	750-1000	1.28-2.05 (32.50-52.0)	2.60 (66.0)	2/0	0.813-1.152 (20.60-29.2)		37 (939)	49 (1244)
CSJA-3523M5	35 kV	1/0-350	1.03-1.49 (26.20-37.8)	2.05 (52.1)	2/0	0.268-0.681 (6.8-17.3)		33 (838)	43 (1090)
CSJA-3524M8	35 kV	350-750	1.28-2.05 (34.54-52.0)	2.60 (66.0)	2/0	0.616-0.998 (15.7-25.3)		37 (939)	49 (1244)
CSJA-3524M9	35 kV	750-1000	1.28-2.05 (34.54-52.0)	2.60 (66.0)	2/0	0.813-1.152 (20.60-29.2)		37 (939)	49 (1244)
CSJA-3525M10	35 kV	1000-1250	1.63-2.36 (41.40-60.0)	2.60 (66.0)	2/0	1.060-1.251 (23.0-31.7)		37 (939)	49 (1244)
* Min/max diameter over cable conductor accepted by the aluminum mechanical connector.									

CSJA JCN/EG In-line Cold Shrinkable Joints

FEATURES

- Total length of the splice body on the holdout is 14 to 19 inches providing a compact design.
- Integrated electrical stress control enhanced by factory molded stress cones and Faraday cage.
- Void filling stress relief mastics are not necessary.
- Proven shield continuity concept. The neutral wires are connected externally. The integrated pre-expanded neutral sock is connected to the neutral wires by a constant force spring. This provides the metallic shielding system to the cable joint.
- The joint accepts both mechanical and compression connectors.
- Meets IEEE-404 standard requirements.

APPLICATIONS

- Cold shrinkable joint for 15 kV through 35 kV. It is designed to splice jacketed concentric neutral (JCN) cables.

BENEFITS

- ♦ This cable joint has a pre-expanded EPDM re-jacketing sleeve and an integrated neutral sock.
- ♦ The "All-in-One" design is easy to install with minimal steps and short installation time.
- ♦ A pre-expanded, single-piece silicone rubber joint body with high mechanical expansion capability allows a wide application range.
- ♦ The silicone rubber body provides high dielectric strength, high tear strength, low tension set, and excellent low temperature recovery.
- ♦ An ergonomically designed spiral holdout provides a smooth installation with low release forces.

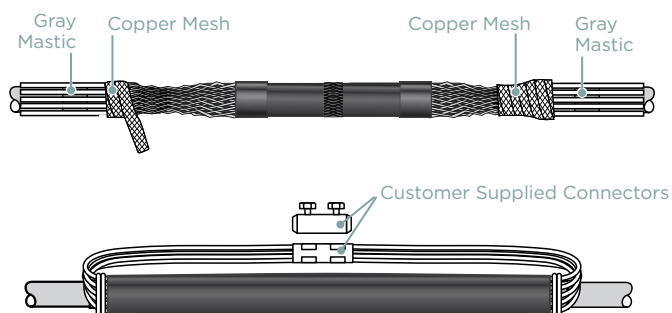

Each silicone splice body is factory tested to include AC withstand and partial discharge in accordance with IEEE-404 production tests.

ADDITIONAL PRODUCT INFORMATION

- Selections are based on the typical dimensions of 100% insulated cables, manufactured in accordance with AEIC standard. Nominal insulation thickness (100%): 15 kV: 175mils, 25 kV: 260mils, 35 kV: 345mils.
- Select the appropriate catalog number. Use the insulation OD, jacket OD and the neutral sock equivalent range as the final ordering criteria. To ensure proper parking diameter, calculate jacket OD with concentric neutrals folded back over jacket.
- For mechanical shear bolt connector included in the kit confirm the correct connector selection according to the Min/Max diameter over the cable conductor from the tables.
- For other applications or if you have any questions, contact your TE representative.
- Standard package: 1 kit/box
- Related test report: EDR-5430, EDR-5455
- For AI Mechanical shear bolt connector information request data sheet 9-1773440-4 and for CU request 165972.

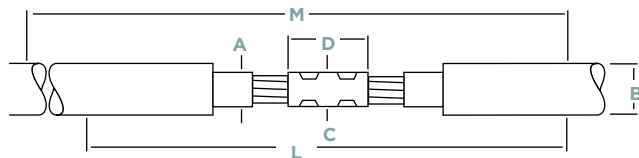
PRODUCT SELECTION INFORMATION: DIMENSIONS IN INCHES (MM)

Catalog Number	Voltage Class	Nominal Cable Range	Min - Max Insulation O.D. (A)	Jacket O.D. (max) (B)	Max Connector Dimensions		Kit Installed Length (L)	Required Install Space (M)
					O.D. (C)	Length (D)		
CSJA JCN/EG Joint Without Connector								
CSJA-JCN/EG-1511	15 kV	#2-350	0.69-1.20 (17.5-30.5)	1.50 (38.1)	1.30 (33.0)	5.50 (140.0)	29 (737)	37 (940)
CSJA-JCN/EG-1512	15 kV	4/0-750	0.87-1.40 (22.1-35.6)	1.80 (46.0)	1.50 (38.0)	5.50 (140.0)	29 (737)	37 (940)
CSJA-JCN/EG-1513	15 kV	350-1000	1.03-1.58 (26.2-40.0)	2.05 (52.1)	1.65 (42.0)	6.69 (170.0)	33 (838)	41 (1041)
CSJA-JCN/EG-1514	15 kV	750-1250	1.28-2.05 (32.50-52.0)	2.60 (66.0)	1.85 (47.0)	7.90 (200.0)	37 (939)	48 (1219)
CSJA-JCN/EG-2812	28 kV	#1-500	0.87-1.40 (22.1-35.6)	1.80 (46.0)	1.50 (38.0)	5.50 (140.0)	29 (737)	37 (940)
CSJA-JCN/EG-2813	28 kV	4/0-750	1.03-1.58 (26.20-40.0)	2.05 (52.1)	1.65 (42.0)	6.69 (170.0)	33 (838)	41 (1041)
CSJA-JCN/EG-2814	28 kV	500-1250	1.28-2.05 (32.50-52.0)	2.60 (66.0)	1.85 (47.0)	7.90 (200.0)	37 (939)	48 (1219)
CSJA-JCN/EG-3513	35 kV	1/0-350	1.03-1.49 (26.20-37.8)	2.05 (52.1)	1.40 (35.6)	5.50 (140.0)	33 (838)	41 (1041)
CSJA-JCN/EG-3514	35 kV	350-1000	1.28-2.05 (34.54-52.0)	2.60 (66.0)	1.96 (50.0)	7.90 (200.0)	37 (939)	48 (1219)
CSJA-JCN/EG-3515	35 kV	750-1250	0.63-2.36 (41.40-60.0)	2.60 (66.0)	2.36 (60.0)	7.90 (200.0)	37 (939)	48 (1219)

Catalog Number	Voltage Class	Nominal Cable Range	Min -Max Insulation O.D. (A)	Jacket O.D. (max) (B)	Min - Max Dia. Over Cable Conductor*	Kit Installed Length (L)	Required Install Space (M)
CSJA JCN/EG Joint With Copper mechanical Shear Bolt Connector*							
CSJA-JCN/EG-1511M1	15 kV	2/0-350	0.69-1.20 (17.5-30.5)	1.50 (38.1)	0.376-0.736 (9.50-18.7)	29 (737)	37 (940)
CSJA-JCN/EG-1512M1	15 kV	4/0-500	0.87-1.40 (22.1-35.6)	1.80 (46.0)	0.376-0.736 (9.50-18.7)	29 (737)	37 (940)
CSJA-JCN/EG-1512M2	15 kV	350-750	0.87-1.40 (22.1-35.6)	1.80 (46.0)	0.570-0.945 (14.5-24.0)	29 (737)	37 (940)
CSJA-JCN/EG-1513M2	15 kV	350-750	1.03-1.58 (26.2-40.0)	2.05 (52.1)	0.570-0.945 (14.5-24.0)	33 (838)	41 (1041)
CSJA-JCN/EG-2812M1	28 kV	2/0-500	0.87-1.40 (22.1-35.6)	1.80 (46.0)	0.376-0.736 (9.50-18.7)	29 (737)	37 (940)
CSJA-JCN/EG-2813M2	28 kV	350-750	1.03-1.58 (26.2-40.0)	2.05 (52.1)	0.570-0.945 (14.5-24.0)	33 (838)	41 (1041)
CSJA-JCN/EG-2814M2	28 kV	500-750	1.28-2.05 (32.50-52.0)	2.60 (66.0)	0.570-0.945 (14.5-24.0)	37 (939)	48 (1219)
CSJA-JCN/EG-3513M1	35 kV	2/0-350	1.03-1.49 (26.20-37.8)	2.05 (52.1)	0.376-0.736 (9.50-18.7)	33 (838)	41 (1041)
CSJA-JCN/EG-3514M2	35 kV	350-750	1.28-2.05 (34.54-52.0)	2.60 (66.0)	0.570-0.945 (14.5-24.0)	37 (939)	48 (1219)

* Min/max diameter over cable conductor accepted by the copper mechanical connector.

Catalog Number	Voltage Class	Nominal Cable Range	Min -Max Insulation O.D. (A)	Jacket O.D. (max) (B)	Min - Max Dia. Over Cable Conductor**	Kit Installed Length (L)	Required Install Space (M)
CSJA JCN/EG Joint With Aluminum Mechanical Shear Bolt Connector**							
CSJA-JCN/EG-1511M4	15 kV	#2-3/0	0.69-1.20 (17.5-30.5)	1.50 (38.1)	0.268-0.470 (6.80-11.9)	29 (737)	37 (940)
CSJA-JCN/EG-1511M5	15 kV	#2-350	0.69-1.20 (17.5-30.5)	1.50 (38.1)	0.268-0.681 (6.80-17.3)	29 (737)	37 (940)
CSJA-JCN/EG-1512M6	15 kV	4/0-500	0.87-1.40 (22.1-35.6)	1.80 (46.0)	0.423-0.813 (10.7-20.6)	29 (737)	37 (940)
CSJA-JCN/EG-1512M7	15 kV	500-750	0.87-1.40 (22.1-35.6)	1.80 (46.0)	0.736-0.998 (18.7-25.3)	29 (737)	37 (940)
CSJA-JCN/EG-1513M8	15 kV	350-750	1.03-1.58 (26.20-40.0)	2.05 (52.1)	0.616-0.998 (15.7-25.3)	33 (838)	41 (1041)
CSJA-JCN/EG-1514M9	15 kV	750-1000	1.28-2.05 (32.50-52.0)	2.60 (66.0)	0.813-1.152 (20.6-29.2)	37 (939)	48 (1219)
CSJA-JCN/EG-2812M5	28 kV	#1-350	0.87-1.40 (22.1-35.6)	1.80 (46.0)	0.268-0.681 (6.80-17.3)	29 (737)	39 (990)
CSJA-JCN/EG-2812M6	28 kV	4/0-500	0.87-1.40 (22.1-35.6)	1.80 (46.0)	0.423-0.813 (10.7-20.6)	29 (737)	39 (990)
CSJA-JCN/EG-2813M8	28 kV	350-750	1.03-1.58 (26.20-40.0)	2.05 (52.1)	0.616-0.998 (15.7-25.3)	33 (838)	41 (1041)
CSJA-JCN/EG-2814M8	28 kV	500-750	1.28-2.05 (32.50-52.0)	2.60 (66.0)	0.616-0.998 (15.7-25.3)	37 (939)	48 (1219)
CSJA-JCN/EG-2814M9	28 kV	750-1000	1.28-2.05 (32.50-52.0)	2.60 (66.0)	0.813-1.152 (20.60-29.2)	37 (939)	48 (1219)
CSJA-JCN/EG-3513M5	35 kV	1/0-350	1.03-1.49 (26.20-37.8)	2.05 (52.1)	0.268-0.681 (6.8-17.3)	33 (838)	41 (1041)
CSJA-JCN/EG-3514M8	35 kV	350-750	1.28-2.05 (34.54-52.0)	2.60 (66.0)	0.616-0.998 (15.7-25.3)	37 (939)	48 (1219)
CSJA-JCN/EG-3514M9	35 kV	750-1000	1.28-2.05 (34.54-52.0)	2.60 (66.0)	0.813-1.152 (20.60-29.2)	37 (939)	48 (1219)
CSJA-JCN/EG-3515M9	35 kV	750-1000	1.63-2.36 (41.40-60.0)	2.60 (66.0)	0.813-1.152 (20.60-29.2)	37 (939)	48 (1219)
CSJA-JCN/EG-3515M10	35 kV	1000-1250	1.63-2.36 (41.40-60.0)	2.60 (66.0)	1.060-1.251 (23.0-31.7)	37 (939)	48 (1219)

** Min/max diameter over cable conductor accepted by the aluminum mechanical connector.

CSJG In-line Cold Shrinkable Joints

FEATURES

- The splice consists of a pre-expanded silicone body on a unique holdout design and separate re-jacketing system.
- A pre-expanded, single piece silicone rubber body with high mechanical expansion capability which allows a wide application range.
- An ergonomically designed spiral holdout provides a smooth installation with low release forces.
- Integrated electrical stress control enhanced by factory molded stress cones and a Faraday cage.
- Meets IEEE-404 standard requirements.

APPLICATIONS

- Cold shrinkable joint for 15 kV through 35 kV. It is designed to splice jacketed concentric neutral (JCN) cables.

BENEFITS

- ♦ This design is easy to install with minimal steps and short installation time.
- ♦ The re-jacketing system is a cold applied wraparound sleeve designed to seal the entire splice and provide mechanical and environmental protection for direct buried installation.
- ♦ Both mechanical and compression connectors can be used.

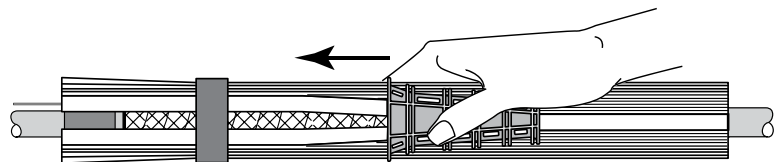
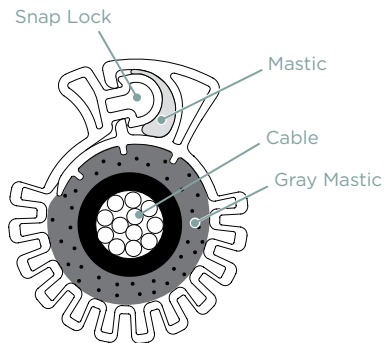
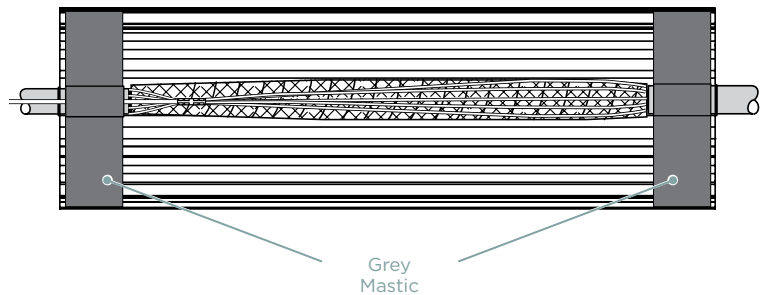
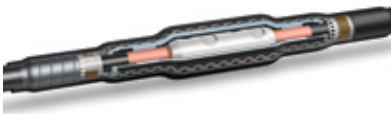

ADDITIONAL PRODUCT INFORMATION

- Selections are based on the typical dimensions of 100% insulated cables, manufactured in accordance with AEIC standard. Nominal insulation thickness (100%): 15 kV: 175 mils, 25 kV: 260 mils, 35 kV: 345 mils.
- Select the appropriate catalog number. Use the insulation OD and jacket OD range as the final ordering criteria.
- For mechanical shear bolt connector included in the kit confirm the correct connector selection according to the Min/Max diameter over the cable conductor from the tables.
- Standard package: 1 kit/box.
- Related test reports: EDR-5430, EDR-5507, EDR-5455.

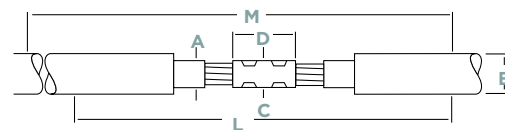
PRODUCT SELECTION INFORMATION: DIMENSIONS IN INCHES (MM)

Catalog Number	Voltage Class	Nominal Cable Range	Min - Max Insulation O.D. (A)	Max Connector Dimensions		Kit Installed Length (L)	Required Install Space (M)
				O.D. (C)	Length (D)		
CSJA JCN/EG Joint Without Connector							
CSJG-1511	15 kV	#2-350	0.69-1.20 (17.5-30.50)	1.30 (33.0)	5.50 (140.0)	33 (850)	42 (1060)
CSJG-1512	15 kV	4/0-750	0.87-1.40 (22.1-35.60)	1.50 (38.0)	5.50 (140.0)	33 (850)	42 (1060)
CSJG-1513	15 kV	350-1000	1.03-1.58 (26.2-40.0)	1.65 (42.0)	6.69 (170.0)	41 (1050)	50 (1270)
CSJG-1514	15 kV	750-1250	1.28-2.05 (32.50-52.0)	1.85 (47.0)	7.90 (200.0)	41 (1050)	55 (1390)
CSJG-2812	28 kV	#1-500	0.87-1.40 (22.1-35.60)	1.50 (38.0)	5.50 (140.0)	33 (850)	42 (1060)
CSJG-2813	28 kV	4/0-750	1.03-1.58 (26.20-40.0)	1.65 (42.0)	6.69 (170.0)	41 (1050)	50 (1270)
CSJG-2814	28 kV	500-1250	1.28-2.05 (32.50-52.0)	1.85 (47.0)	7.90 (200.0)	41 (1050)	55 (1390)
CSJG-3513	35 kV	1/0-350	1.03-1.49 (26.20-37.80)	1.40 (35.6)	5.50 (140.0)	41 (1050)	50 (1270)
CSJG-3514	35 kV	350-1000	1.28-2.05 (34.54-52.0)	1.96 (50.0)	7.90 (200.0)	41 (1050)	55 (1390)
CSJG-3515	35 kV	750-1250	1.63-2.36 (41.40-60.0)	2.36 (60.0)	7.90 (200.0)	41 (1050)	55 (1390)

Catalog Number	Voltage Class	Nominal Cable Range	Min - Max Insulation O.D. (A)	Min - Max Dia. Over Cable Conductor	Kit Install Length (L)	Required Install Space (M)
CSJG Joint with Copper Shear Bolt Connector*						
CSJG-1511M1	15 kV	2/0-350	0.69-1.20 (17.5-30.50)	0.376-0.736 (9.50-18.70)	33 (850)	42 (1060)
CSJG-1512M1	15 kV	4/0-500	0.87-1.40 (22.1-35.60)	0.376-0.736 (9.50-18.70)	33 (850)	42 (1060)
CSJG-1512M2	15 kV	350-750	0.87-1.40 (22.1-35.60)	0.570-0.945 (14.5-24.0)	33 (850)	42 (1060)
CSJG-1513M2	15 kV	350-750	1.03-1.58 (26.2-40.0)	0.570-0.945 (14.5-24.0)	41 (1050)	50 (1270)
CSJG-2812M1	28 kV	2/0-500	0.87-1.40 (22.1-35.60)	0.376-0.736 (9.50-18.70)	33 (850)	42 (1060)
CSJG-2813M2	28 kV	350-750	1.03-1.58 (26.2-40.0)	0.570-0.945 (14.5-24.0)	41 (1050)	50 (1270)
CSJG-2814M2	28 kV	500-750	1.28-2.05 (32.50-52.0)	0.570-0.945 (14.5-24.0)	41 (1050)	55 (1390)
CSJG-3513M1	35 kV	2/0-350	1.03-1.49 (26.20-37.80)	0.376-0.736 (9.50-18.70)	41 (1050)	50 (1270)
CSJG-3514M2	35 kV	350-750	1.28-2.05 (34.54-52.0)	0.570-0.945 (14.5-24.0)	41 (1050)	55 (1390)
* Min/max diameter over cable conductor accepted by the copper mechanical connector.						
CSJG Joint with Aluminum Shear Bolt Connector**						
CSJG-1511M4	15 kV	#2-3/0	0.69-1.20 (17.5-30.50)	0.268-0.470 (6.80-11.9)	33 (850)	42 (1060)
CSJG-1511M5	15 kV	#2-350	0.69-1.20 (17.5-30.50)	0.268-0.681 (6.80-17.3)	33 (850)	42 (1060)
CSJG-1512M6	15 kV	4/0-500	0.87-1.40 (22.1-35.60)	0.423-0.813 (10.7-20.6)	33 (850)	42 (1060)
CSJG-1512M7	15 kV	500-750	0.87-1.40 (22.1-35.60)	0.736-0.998 (18.7-25.3)	33 (850)	42 (1060)
CSJG-1513M8	15 kV	350-750	1.03-1.58 (26.20-40.0)	0.616-0.998 (15.7-25.3)	41 (1050)	50 (1270)
CSJG-1514M9	15 kV	750-1000	1.28-2.05 (32.50-52.0)	0.813-1.152 (20.6-29.2)	41 (1050)	55 (1390)
CSJG-2812M5	28 kV	#1-350	0.87-1.40 (22.1-35.60)	0.268-0.681 (6.80-17.3)	33 (850)	42 (1060)
CSJG-2812M6	28 kV	4/0-500	0.87-1.40 (22.1-35.60)	0.423-0.813 (10.7-20.6)	33 (850)	42 (1060)
CSJG-2813M8	28 kV	350-750	1.03-1.58 (26.20-40.0)	0.616-0.998 (15.7-25.3)	41 (1050)	50 (1270)
CSJG-2814M8	28 kV	500-750	1.28-2.05 (32.50-52.0)	0.616-0.998 (15.7-25.3)	41 (1050)	55 (1390)
CSJG-2814M9	28 kV	750-1000	1.28-2.05 (32.50-52.0)	0.813-1.152 (20.60-29.2)	41 (1050)	55 (1390)
CSJG-3513M5	35 kV	1/0-350	1.03-1.49 (26.20-37.80)	0.268-0.681 (6.8-17.3)	41 (1050)	50 (1270)
CSJG-3514M8	35 kV	350-750	1.28-2.05 (34.54-52.0)	0.616-0.998 (15.7-25.3)	41 (1050)	55 (1390)
CSJG-3514M9	35 kV	750-1000	1.28-2.05 (34.54-52.0)	0.813-1.152 (20.60-29.2)	41 (1050)	55 (1390)
CSJG-3515M10	35 kV	1000-1250	1.63-2.36 (41.40-60.0)	1.060-1.251 (23.0-31.7)	41 (1050)	55 (1390)
** Min/max diameter over cable conductor accepted by the aluminum mechanical connector.						

3/C CSJA Cold Shrinkable Joint

FEATURES

- The splice consists of three pre-expanded silicone bodies on a unique holdout and a separate re-jacketing system.
- An ergonomically designed spiral holdout provides a smooth installation with low release forces.
- Integrated electrical stress control enhanced by factory molded stress cones and a Faraday cage.
- Meets IEEE-404 standard requirements.

APPLICATIONS

- For 15 kV through 35 kV. Designed to splice 3/C Armored Cables.
- The GMRS re-jacketing system is a cold-applied wrap around sleeve that eliminates parking distance

BENEFITS

- ♦ This design is easy to install with minimal steps and a short installation time.
- ♦ The re-jacketing system is a cold applied wraparound sleeve designed to seal the entire splice and provide mechanical and environmental protection for direct buried installations.
- ♦ Both mechanical and compression connectors can be used.
- ♦ Pre-expanded, single piece silicone rubber body with high mechanical expansion capability which allows a wide application range.

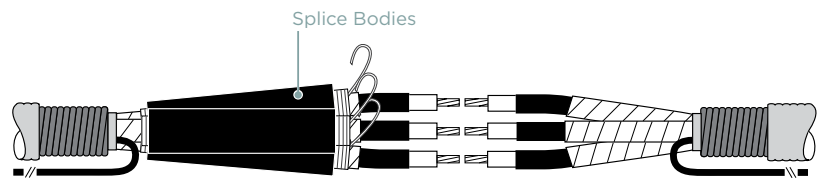

ADDITIONAL PRODUCT INFORMATION

- Selections are based on the typical dimensions of 100% insulated cables, manufactured in accordance with AEIC standard. Nominal insulation thickness (100%): 15 kV: 175 mils, 25 kV: 260 mils, 35 kV: 345 mils.
- Select the appropriate catalog number. Use the insulation OD and jacket OD range as the final ordering criteria.
- For mechanical shear bolt connector included in the kit confirm the correct connector selection according to the Min./Max. diameter over the cable conductor from the tables.
- Standard package: 1 kit/box.
- Related test reports: EDR-5530.

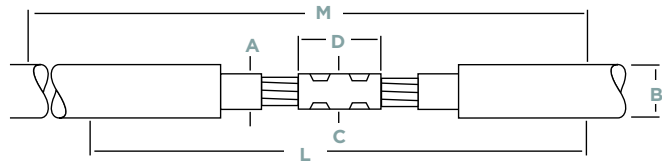
PRODUCT SELECTION INFORMATION: DIMENSIONS IN INCHES (MM)

Catalog Number	Voltage Class	Nominal Cable Range	Min - Max Insulation O.D. (A)	Max Connector Dimensions		Kit Installed Length (L)	Required Install Space (M)
				O.D. (C)	Length (D)		
CSJA 3/C Joint without Connector							
CSJA-3-1521-ARMR	15 kV	#2-350	0.69-1.20 (17.5-30.5)	1.30 (33.0)	5.50 (140.0)	65 (1650)	65 (1650)
CSJA-3-1522-ARMR	15 kV	4/0-750	0.87-1.40 (22.1-35.6)	1.50 (38.0)	5.50 (140.0)	65 (1650)	65 (1650)
CSJA-3-1523-ARMR	15 kV	350-1000	1.03-1.58 (26.2-40.0)	1.65 (42.0)	6.69 (170.0)	71 (1800)	71 (1800)
CSJA-3-2822-ARMR	28 kV	#1-500	0.87-1.40 (22.1-35.6)	1.50 (38.0)	5.50 (140.0)	65 (1650)	65 (1650)
CSJA-3-2823-ARMR	28 kV	4/0-750	1.03-1.58 (26.2-40.0)	1.65 (42.0)	6.69 (170.0)	71 (1800)	71 (1800)
CSJA-3-3523-ARMR	35 kV	1/0-350	1.03-1.49 (26.2-37.8)	1.40 (35.6)	5.50 (140.0)	71 (1800)	71 (1800)
CSJA-3-3524-ARMR	35 kV	350-1000	1.36-1.63 (34.54-41.4)	1.62 (42.0)	6.69 (170)	71 (1800)	71 (1800)

Catalog Number	Voltage Class	Nominal Cable Range	Min - Max Insulation O.D. (A)	Min - Max Dia. Over Cable Conductor	Kit Installed Length (L)	Required Install Space (M)
CSJA-3/C Joint with Copper Shear Bolt Connector*						
CSJA-3-1521M1-ARMR	15 kV	#2-350	0.69-1.20 (17.5-30.5)	0.376-0.736 (9.5-18.7)	65 (1650)	65 (1650)
CSJA-3-1522M1-ARMR	15 kV	4/0-500	0.87-1.40 (22.1-35.6)	0.376-0.736 (9.5-18.7)	65 (1650)	65 (1650)
CSJA-3-1522M2-ARMR	15 kV	350-750	0.87-1.40 (22.1-35.6)	0.570-0.945 (14.5-24.0)	71 (1800)	71 (1800)
CSJA-3-1523M3-ARMR	15 kV	500-1000	1.03-1.58 (26.2-40.0)	0.736-1.152 (18.7-29.3)	71 (1800)	71 (1800)
CSJA-3-2822M1-ARMR	28 kV	2/0-500	0.87-1.40 (22.1-35.6)	0.376-0.736 (9.5-18.7)	65 (1650)	65 (1650)
CSJA-3-2823M2-ARMR	28 kV	350-750	1.03-1.58 (26.2-40.0)	0.570-0.945 (14.5-24.0)	71 (1800)	71 (1800)
CSJA-3-3523M1-ARMR	35 kV	2/0-350	1.03-1.49 (26.2-37.8)	0.376-0.736 (9.5-18.7)	71 (1800)	71 (1800)
CSJA-3-3524M2-ARMR	35 kV	350-750	1.36-2.05 (34.54-54.0)	0.570-0.945 (14.5-24.0)	71 (1800)	71 (1800)

* Min/max diameter over cable conductor accepted by the copper mechanical connector.

Catalog Number	Voltage Class	Nominal Cable Range	Min - Max Insulation O.D. (A)	Min - Max Dia. Over Cable Conductor	Kit Installed Length (L)	Required Install Space (M)
CSJA-3/C Joint with Aluminum Shear Bolt Connector**						
CSJA-3-1521M4-ARMR	15 kV	#2-3/0	0.69-1.20 (17.5-30.5)	0.268-0.470 (6.8-11.9)	65 (1650)	65 (1650)
CSJA-3-1521M5-ARMR	15 kV	#2-350	0.69-1.20 (17.5-30.5)	0.268-0.681 (6.8-17.3)	65 (1650)	65 (1650)
CSJA-3-1522M6-ARMR	15 kV	4/0-500	0.87-1.40 (22.1-35.6)	0.423-0.813 (10.7-20.6)	71 (1800)	71 (1800)
CSJA-3-1522M7-ARMR	15 kV	500-750	0.87-1.40 (22.1-35.6)	0.736-0.998 (18.7-25.3)	71 (1800)	71 (1800)
CSJA-3-1523M8-ARMR	15 kV	350-750	1.03-1.58 (26.2-40.0)	0.616-0.998 (15.7-25.3)	71 (1800)	71 (1800)
CSJA-3-2822M5-ARMR	28 kV	#1-350	0.87-1.40 (22.1-35.6)	0.268-0.681 (6.8-17.3)	65 (1650)	65 (1650)
CSJA-3-2822M6-ARMR	28 kV	4/0-500	0.87-1.40 (22.1-35.6)	0.423-0.813 (10.7-20.6)	65 (1650)	65 (1650)
CSJA-3-2823M8-ARMR	28 kV	350-750	1.03-1.58 (26.2-40.0)	0.616-0.998 (15.7-25.3)	71 (1800)	71 (1800)
CSJA-3-3523M5-ARMR	35 kV	1/0-350	1.03-1.49 (26.2-37.8)	0.268-0.681 (6.8-17.3)	71 (1800)	71 (1800)
CSJA-3-3524M8-ARMR	35 kV	350-750	1.36-2.05 (34.54-54.0)	1.060-1.251 (23.0-31.7)	71 (1800)	71 (1800)

** Min/max diameter over cable conductor accepted by the aluminum mechanical connector.

CSJU Cold Shrink Joint for Underground Residential Distribution Cables

FEATURES

- Pre-expanded, single piece silicone rubber joint body with high mechanical expansion capability allows a wide application range.
- Pre-expanded EPDM re-jacketing sleeve provides superior moisture and environmental sealing.
- Option to include range-taking aluminum Shear Bolt or aluminum compression splice.
- TE's Raychem material proven by cold shrink products in service for decades.
- Total length of the splice body on the holdout is 12 inches proving a compact design.

APPLICATIONS

- Cold shrinkable joint for 15 kV through 25 kV. It is designed to splice jacketed concentric neutral (JCN) cables.
- The CSJU-S, a product extension to the CSJU, is intended for use on other neutral types.

BENEFITS

- ♦ All-in-One design is compact and requires less working space (trench) to install.
- ♦ An ergonomically designed spiral holdout provides a smooth installation with low release forces.
- ♦ Meets IEEE-404 requirements for 15 kV through 25 kV.
- ♦ Each silicone splice body is factory tested to include AC withstand and partial discharge in accordance with IEEE-404 production tests.
- ♦ Cold weather and impact testing executed to ensure top performance in challenging conditions.



PRODUCT SELECTION INFORMATION: DIMENSIONS IN INCHES (MM)

Catalog Number	Voltage Class	Nominal Cable Range	Min - Max Insulation O.D.	Max Jacket Dimensions O.D.	Min - Max Diameter Over Cable Conductor
CSJU Joint without Connector					
CSJU-1511	15 kV	#2-4/0	0.64-0.99 (16.3 - 25.1)	1.26 (32.0)	1.00 (25.4) 3.25 (82.5)
CSJU-2511	25 kV	#1-2/0	0.84-1.03 (21.3 - 26.2)	1.26 (32.0)	1.00 (25.4) 3.25 (82.5)

Catalog Number	Voltage Class	Nominal Cable Range	Min - Max Insulation O.D.	Max Jacket Dimensions O.D.
CSJU Joint with Aluminum Mechanical Shear Bolt Connector				
CSJU-1511-SB1	15 kV	#2-1/0	0.64-0.99 (16.3 - 25.1)	1.26 (32.0)
CSJU-1511-SB2	15 kV	#2-4/0	0.64-0.99 (16.3 - 25.1)	1.26 (32.0)
CSJU-2511-SB1	25 kV	#1-1/0	0.84-1.03 (21.3 - 26.2)	1.26 (32.0)
CSJU-2511-SB2	25 kV	#1-2/0	0.84-1.03 (21.3 - 26.2)	1.26 (32.0)
CSJU Joint with Aluminum Compression Connector				
CSJU-1511-ALC0	15 kV	#2 STR-SOL, #1 SOL	0.64 - 0.99 (16.3 - 25.1)	1.26 (32.0)
CSJU-1511-ALC1	15 kV	#1 STR-CPT, 1/0 CPT-SOL	0.64 - 0.99 (16.3 - 25.1)	1.26 (32.0)
CSJU-1511-ALC2	15 kV	1/0 STR-CMPR, 2/0 CPT	0.64 - 0.99 (16.3 - 25.1)	1.26 (32.0)
CSJU-1511-ALC3	15 kV	2/0-STR-CMPR, 3/0 CPT	0.64 - 0.99 (16.3 - 25.1)	1.26 (32.0)
CSJU-1511-ALC4	15 kV	3/0 STR-CMPR, 4/0 CPT	0.64 - 0.99 (16.3 - 25.1)	1.26 (32.0)
CSJU-1511-ALC5	15 kV	4/0 STR-CMPR	0.64 - 0.99 (16.3 - 25.1)	1.26 (32.0)
CSJU-2511-ALC0	25 kV	#2 STR-SOL, #1 SOL	0.84 - 1.03 (21.3 - 26.2)	1.26 (32.0)
CSJU-2511-ALC1	25 kV	#1 STR-CPT, 1/0 CPT-SOL	0.84 - 1.03 (21.3 - 26.2)	1.26 (32.0)
CSJU-2511-ALC2	25 kV	1/0 STR-CMPR, 2/0 CPT	0.84 - 1.03 (21.3 - 26.2)	1.26 (32.0)
CSJU-2511-ALC3	25 kV	2/0-STR-CMPR, 3/0 CPT	0.84 - 1.03 (21.3 - 26.2)	1.26 (32.0)

ADDITIONAL PRODUCT INFORMATION

- Selections are based on the typical dimensions of 100% insulated cables, manufactured in accordance with AEIC standard. Nominal insulation thickness (100%): 15 kV: 175mils, 25 kV: 260mils.
- Select the appropriate catalog number using the insulation O.D. and jacket O.D. range as the final ordering criteria.
- For other applications or if you have questions, contact your TE representative.
- Standard package: 1 kit per box.
- Related test reports: EDR 5643, EDR 5644

HVT-50 1/C | 3/C Non-Shielded Power Cable (5 kV)

FEATURES

- Designed to withstand rigorous service conditions.

APPLICATIONS

- Non-shielded polymeric terminations for 5 kV cable

BENEFITS

- ♦ The nontracking, heat-shrinkable insulation is simple to install and provides excellent UV stability.



PRODUCT SELECTION INFORMATION: DIMENSIONS IN INCHES (MM)

Catalog Number	Conductor Size (AWG/kcmil)	Insulation Diameter (min)	Jacket O.D. (max)
HVT-51	#4-2/0	0.45 (11)	0.85 (22)
HVT-52	3/0-500	0.70 (18)	1.30 (33)
HVT-53	750-1500	1.10 (28)	2.15 (55)

Installed length: 12 (300)

FOR THREE-CONDUCTOR 5 KV TERMINATIONS

Order three appropriate single-conductor terminations from the selection information above. In addition, order the appropriate three-conductor modification kit (MOD-3-HVT) as follows:
 MOD-3A-HVT for HVT-51 and HVT-52
 MOD-3B-HVT for HVT-53

These MOD-3-HVT kits contain:

- 4 feet of tubing to re-jacket each phase and ground conductor
- Sealant
- Plugs
- Cable breakout to seal the crotch area

ADDITIONAL PRODUCT INFORMATION

- Select the appropriate catalog number. All selections are based on the typical dimensions of 100% insulated cables manufactured in accordance with the data contained in ICEA S-66-524, as well as the dimensions of commonly used connectors. Nominal insulation thickness (100%): 90 mils.
- For cables manufactured to other specifications, confirm selection with cable dimensions.
- Kits do not contain connectors; order compression, shear bolt, or solder connectors.
- Standard package:
 - HVT-50: 3 single-conductor kits/box.
 - MOD-3-HVT: 1 kit/box.
- Cable mounting brackets are available to accommodate cable diameters from 0.80-2.40 inches (20-61 mm).

HVT-Z-J/SJ Terminations with Built-in Stress Control

FEATURES

- When the tubing is shrunk down, the coating softens and sticks to irregular surfaces, providing moisture seals as well as electrical stress control.
- TE's Raychem HVT-Z high-voltage terminations meet IEEE-48 standard Class I termination requirement.

APPLICATIONS

- As an option, the HVT-Z can also be ordered with TE's new line of Aluminum Shear Bolt Terminals. These are range taking mechanical connectors that will accommodate a conductor range from #2 compact to 1000 kcmil stranded, Class B.

BENEFITS

- Can be installed inverted or upright
- The main termination component consists of TE's Raychem non-tracking tube together with a co-extruded stress control grading layer. This stress control layer is based on ceramic semi-conductor technology (ZnO) and provides superior discharge and impulse performance.
- Unlimited shelf life when stored in normal conditions



PRODUCT SELECTION INFORMATION: DIMENSIONS IN INCHES (MM)

Indoor Kit	Outdoor Kit	Min - Max Conductor Size		Insulation Dia (min - max)	Jacket O.D. (max)
15 kV*		15 kV (100%)	15 kV (133%)		
HVT-Z-151-J	HVT-Z-151-SJ	#2-#1 AWG		0.60-0.95	1.05
HVT-Z-152-J	HVT-Z-152-SJ	#2/0-250 kcmil	#2-4/0 AWG	0.80-1.05	1.45
HVT-Z-153-J	HVT-Z-153-SJ	350-500 kcmil	250-500 kcmil	1.05-1.40	1.9
HVT-Z-154-J	HVT-Z-154-SJ	750-1000 kcmil	750-1000 kcmil	1.25-2.00	2.5
25 kV/35 kV**		25 kV	35 kV		
HVT-Z-252/352-J	HVT-Z-252/352-SJ	#1-3.0 AWG		0.80-1.05	1.45
HVT-Z-253/353-J	HVT-Z-253/353-SJ	#4/0-500 kcmil	#1/0-4/0 AWG	1.05-1.40	1.9
HVT-Z-254/354-J	HVT-Z-254/354-SJ	750-1000 kcmil	250-1000 kcmil	1.25-2.00	2.5

*Installed Length 11.5' (300)

**Installed Length 20' (500)

ADDITIONAL PRODUCT INFORMATION

- Select the appropriate catalog number. All selections are based on the typical dimensions of 100% and 133% insulated cables manufactured in accordance with the data contained in AEIC CS5 and AEIC CS6, as well as the dimensions of commonly used connectors. Nominal Insulation thickness (100%): 15 kV: 175 mils, 25 kV: 260 mils, 35 kV: 345 mils. Nominal thickness (133%): 15 kV: 220 mils.
- For cables manufactured to other specifications, confirm selection with cable dimensions.
- Kits do not contain connectors. Order compression, shear bolt, or solder connectors separately.
- Indoor (-J) kits are suitable for unjacketed and jacketed URD cable.
- Outdoor (-SJ) kits include skirts for outdoor use and are suitable for unjacketed and jacketed URD cable. To order additional skirts refer to Accessory and Tool section.
- Cable mounting brackets are available to accommodate cable diameters from 0.80-2.40 inches (20-46 mm) refer to Accessory and Tools section for ordering information.
- Standard package: 1 kit/box.
- Refer to the Application and Technical Specification section for testing information.
- Related test reports:
 - Outdoor: 15 kV: EDR-5323, 25-35 kV: EDR-5338.
 - Indoor: 15 kV: EDR-5322, 25-35 kV: EDR-5338.

HVT-Z-G/SG High Voltage Termination for shielded cables (5 kV-35 kV)

FEATURES

- When the tubing is shrunk down, the coating softens and sticks to irregular surfaces, providing moisture seals as well as electrical stress control.
- TE's Raychem HVT-Z high-voltage terminations meet IEEE-48 standard Class I termination requirement.

APPLICATIONS

- The market's most popular heat shrink terminations!
- Designed for Copper Tape Shield, Wire Shield, Unshield, and Lead Sheath cables from 5 kV to 35 kV

BENEFITS

- The main termination component consists of TE's Raychem non-tracking tube together with a co-extruded stress control grading layer. This stress control layer is based on ceramic semi-conductor technology (ZnO) and provides superior discharge and impulse performance.
- Unlimited shelf life when stored in normal conditions

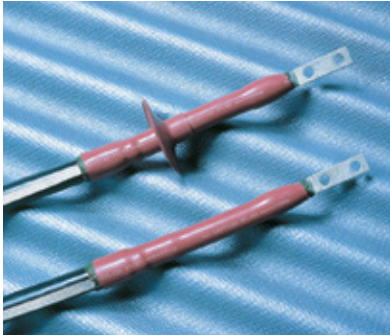

PRODUCT SELECTION INFORMATION: DIMENSIONS IN INCHES (MM)

Indoor Kit	Outdoor Kit	Min - Max Conductor Size		Min - Max Insulation Dia	Jacket O.D. (max)
5/8 kV		5 kV 0.90	8 kV 0.115		
HVT-Z-80-G/SG		#4-#1 AWG	#6-#2 AWG	0.35-0.60 (9-15)	0.95 (24)
HVT-Z-81-G/SG		1/0-250 kcmil	#1-4/0 AWG	0.60-0.95 (15-24)	1.20 (30)
HVT-Z-82-G/SG		300-500 kcmil	250-500 kcmil	0.80-1.25 (20-32)	1.50 (38)
HVT-Z-83-G/SG		600-1750 kcmil	600-1750 kcmil	1.10-1.75 (28-44)	2.10 (53)
HVT-Z-84-G/SG		1500-3500 kcmil	1500-2500 kcmil	1.60-2.45 (41-62)	2.75 (70)
<i>Installed Length 11.5" (295)</i>		<i>Can be cut shorter for use with MCK kits</i>		<i>No Skirts for Outdoor Operation*</i>	
15 kV		15 kV .175-.220			
HVT-Z-151-G	HVT-Z-151-SG	#4-1/0 AWG		0.60-0.95 (15-24)	1.20 (30)
HVT-Z-152-G	HVT-Z-152-SG	2/0-350 kcmil		0.80-1.25 (20-32)	1.50 (38)
HVT-Z-153-G	HVT-Z-153-SG	400-1000 kcmil		1.10-1.75 (28-44)	2.10 (53)
HVT-Z-154-G	HVT-Z-154-SG	1250-2500 kcmil		1.60-2.45 (41-62)	2.75 (70)
<i>Installed Length 11.5" (295)</i>				<i>1 Skirt for Outdoor Operation*</i>	
25 kV/35 kV		25 kV 0.260	35 kV 0.345		
HVT-Z-252/352-G	HVT-Z-252/352-SG	#2-250 kcmil	#1-1/0 AWG	0.80-1.25 (20-32)	1.50 (38)
HVT-Z-253/353-G	HVT-Z-253/353-SG	300-750 kcmil	2/0-500 kcmil	1.10-1.75 (28-44)	2.10 (53)
HVT-Z-254/354-G	HVT-Z-254/354-SG	1000-2000 kcmil	750-1750 kcmil	1.60-2.45 (41-62)	2.75 (70)
<i>Installed Length 19.0" (485)</i>				<i>4 Skirts for Outdoor Operation*</i>	

*Additional skirts sold separately. Refer to Accessory and Tool section.

PRODUCT SELECTION INFORMATION: DIMENSIONS IN INCHES (MM)

Indoor Kit	Outdoor Kit	Min - Max Conductor Size		Min - Max Insulation Dia.	Jacket O.D. (max)
HVT-Z Termination with Aluminum Shear Bolt Terminal					
5/8 kV		5 kV	8 kV		
HVT-Z-81-G/SG-T5		1/0-250 kcmil	#1-4/0 AWG	0.60-0.95 (15-24)	1.20 (30)
HVT-Z-82-G/SG-T5		300-350 kcmil	250-350 kcmil	0.80-1.07 (20-27)	1.50 (38)
HVT-Z-82-G/SG-T8		350-500 kcmil	350-500 kcmil	0.85-1.25 (22-32)	1.50 (38)
HVT-Z-83-G/SG-T9		600-1000 kcmil	600-1000 kcmil	1.10-1.40 (28-36)	2.10 (53)
<i>No Skirts for Outdoor Operation*</i>					
15 kV		15 kV			
HVT-Z-151-G-T5	HVT-Z-151-SG-T5	#2-1/0 AWG		0.65-0.95 (17-24)	1.20 (30)
HVT-Z-152-G-T5	HVT-Z-152-SG-T5	2/0-350 kcmil		0.80-1.25 (20-32)	1.50 (38)
HVT-Z-153-G-T8	HVT-Z-153-SG-T8	400-500 kcmil		1.10-1.355 (28-34)	2.10 (53)
HVT-Z-153-G-T9	HVT-Z-153-SG-T9	600-1000 kcmil		1.215-1.65 (32-42)	2.10 (53)
<i>1 Skirt for Outdoor Operation*</i>					
25 kV/35 kV		25 kV (0.260")	35 kV (0.345")		
HVT-Z-252/352-G-T5	HVT-Z-252/352-SG-T5	#2-250 kcmil	#1-1/0 AWG	0.80-1.25 (20-32)	1.50 (38)
HVT-Z-253/353-G-T5	HVT-Z-253/353-SG-T5	300-350 kcmil	2/0-350 kcmil	1.10-1.50 (28-38)	2.0 (51)
HVT-Z-253/353-G-T8	HVT-Z-253/353-SG-T8	350-750 kcmil	350-500 kcmil	1.185-1.70 (30-43)	2.10 (53)
HVT-Z-254/354-G-T9	HVT-Z-254/354-SG-T9	600-1000 kcmil	600-1000 kcmil	1.60-1.79 (41-45)	2.75 (70)
<i>4 Skirts for Outdoor Operation*</i>					

*Additional skirts sold separately. Refer to Accessory and Tool section.

ADDITIONAL PRODUCT INFORMATION

- Select the appropriate catalog number. All selections are based on the typical dimensions of 100% and 133% insulated cables manufactured in accordance with the data contained in AEIC CS5 and AEIC CS6, as well as the dimensions of commonly used connectors. Nominal Insulation thickness (100%): 15 kV: 175 mils, 25 kV: 260 mils, 35 kV: 345 mils. Nominal thickness (133%): 15 kV: 220 mils.
- For cables manufactured to other specifications, confirm selection with cable dimensions.
- Some kits do not contain connectors. Order compression, shear bolt, or solder connectors separately.
- Cable mounting brackets are available to accommodate cable diameters from 0.80-2.40 inches (20-46 mm) refer to Accessory and Tools section for ordering information.
- Standard package: 1 kit/box.
- Refer to the Application and Technical Specification section for testing information.
- Related test reports: 15 kV: EDR-5322, EDR-5323, 25 kV: EDR-5473 35 kV: EDR-5481

MOD-3-HVT 3/C Modification Kits

FEATURES

- Cut-to-length re-jacketing material for phases and grounds included in all kits.
- 3A and 3B kits include a six-legged, environmental crotch sealing boot (adhesive lined) and plugs for unused grounding legs



APPLICATIONS

- Use TE's Raychem MOD-3-HVT kits in conjunction with three 1/C terminations to seal and re-jacket the cable terminations (5 - 35 kV).

BENEFITS

- ♦ MOD-3-HVT kits are available for both unsealed and sealed applications.
- ♦ Comprised of high quality materials for a long, trouble free service life.
- ♦ Unlimited shelf life when stored in normal conditions

PRODUCT SELECTION INFORMATION: DIMENSIONS IN INCHES (MM)

Indoor (Without Breakout Boot)	
1/C Termination Indoor	MOD-3-HVT Kit
5-8 kV	Indoor
HVT-Z-80-G/SG	MOD-3X-HVT*
HVT-Z-81-G/SG	MOD-3X-HVT
HVT-Z-82-G/SG	MOD-3X-HVT
HVT-Z-83-G/SG	MOD-3Y-HVT
HVT-Z-84-G/SG	MOD-3Y-HVT
15 kV	
HVT-Z-151-G	MOD-3X-HVT
HVT-Z-152-G	MOD-3X-HVT
HVT-Z-153-G	MOD-3Y-HVT
HVT-Z-154-G	MOD-3Y-HVT
25 kV and 35 kV	
HVT-Z-252/352-G	MOD-3X-HVT
HVT-Z-253/353-G	MOD-3Y-HVT
HVT-Z-254/354-G	MOD-3Y-HVT

*Confirm insulation diameter and jacket OD information with table below

Outdoor/Indoor (Includes Breakout Boot)	
1/C Termination	MOD-3-HVT Kit
5-8 kV	In/Outdoor Sealed
HVT-Z-80-G/SG	MOD-3A-HVT*
HVT-Z-81-G/SG	MOD-3A-HVT
HVT-Z-82-G/SG	MOD-3A-HVT
HVT-Z-83-G/SG	MOD-3B-HVT
HVT-Z-84-G/SG	MOD-3B-HVT*
15 kV	
HVT-Z-151-SG	MOD-3A-HVT
HVT-Z-152-SG	MOD-3A-HVT
HVT-Z-153-SG	MOD-3B-HVT
HVT-Z-154-SG	MOD-3B-HVT*
25 kV and 35 kV	
HVT-Z-252/352-SG	MOD-3A-HVT
HVT-Z-253/353-SG	MOD-3B-HVT
HVT-Z-254/354-SG	MOD-3B-HVT*

Catalog Number	Insulation Diameter (min - max)	Jacket O.D. (min - max)
MOD-3X-HVT (unsealed)	0.50-1.35 (13-34)	
MOD-3Y-HVT (unsealed)	1.00-2.70 (25-69)	
MOD-3A-HVT (sealed)	0.50-1.25 (13-32)	1.25-3.85 (32-98)
MOD-3B-HVT (sealed)	1.00-2.10 (25-53)	2.65-5.30 (67-135)

ADDITIONAL PRODUCT INFORMATION

- To select the appropriate modification kit for the HVT terminations, use the MOD-3-HVT selection table above.
- Use the MOD-3-HVT dimensions table to confirm the insulation and jacket diameters. If the diameters of your cable fall outside the MOD-3-HVT kit's use range, you can purchase MOD-3-HVT components separately. To order separately, use the ordering information on the next page.

3/C CABLE TERMINATING

MOD-3X-HVT and MOD-3Y-HVT are for jacketing of phases and ground conductors. MOD-3A-HVT and MOD-3B-HVT provide jacketing, plus an environmental crotch sealing boot. Tubing provided does not have sealant coating on the inner wall. This makes it easy to remove, like any cable jacket. Each kit includes three 4-foot long sleeves for the phases and three 4-foot long smaller sleeves for any ground conductors. (Tubing can be field-cut to appropriate length.) A unique six-legged cable breakout boot, provided in -3A and -3B kits, has an internal coating of a special adhesive to provide total environmental sealing of the cable crotch (breakout) area. It has three large legs for the phases and three smaller legs for ground conductors. Plugs are included for insertion into any unused ground legs to maintain the environmental seal integrity.

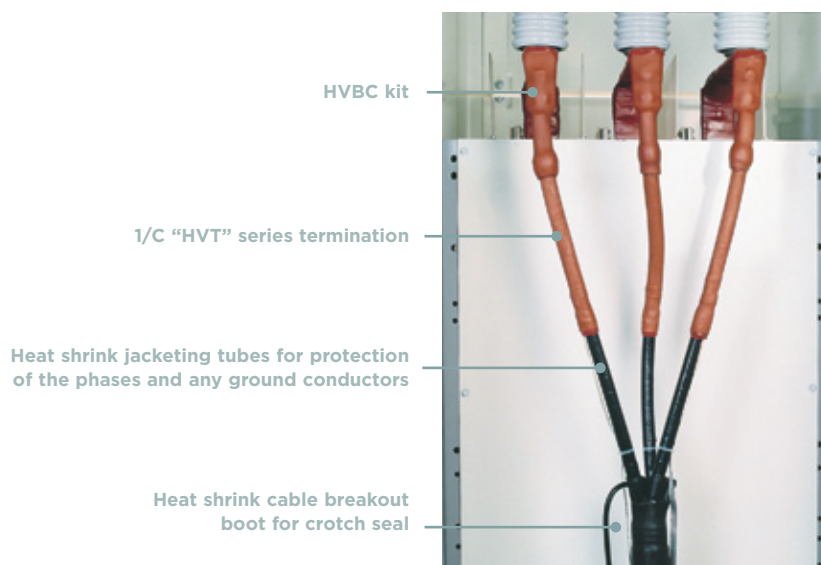

4

MOD-3-HVT KIT COMPONENTS AND BULK ORDERING INFORMATION

Catalog Number	Kit Catalog	Component Catalog Number	Bulk Ordering Catalog Number
MOD-3X-HVT	Uncoated tubing to re-jacket each phase Uncoated tubing to re-jacket each ground Sealant strip	3 each MWTM-35/12-1200/U 3 each MWTM-16/5-1500/U 1 each S1085-3-380	MWTM-35/12-A/U MWTM-16/5-A/U S1085-3-380
MOD-3Y-HVT	Uncoated tubing to re-jacket each phase Uncoated tubing to re-jacket each ground Sealant strip	3 each MWTM-85/25-1500/U 3 each MWTM-16/5-1200/U 1 each S1085-3-380	MWTM-85/25-A/U MWTM-16/5-A/U S1085-3-380
MOD-3A-HVT	Uncoated tubing to re-jacket each phase Uncoated tubing to re-jacket each ground Sealant strip Cable breakout boot Cable breakout plugs Sealant-coated shim tubing	3 each MWTM-35/12-1200/U 3 each MWTM-16/5-1200/U 1 each S1085-3-380 1 each CBR-6-1-A 3 each CBR-PLUG 1 each WCSM-70/20-150-S	MWTM-35/12-A/U MWTM-16/5-A/U S1085-3-380 CBR-6-1-A CBR-PLUG WCSM-70/20-1200-S
MOD-3B-HVT	Uncoated tubing to re-jacket each phase Uncoated tubing to re-jacket each ground Sealant strip Cable breakout boot Cable breakout plugs Ground wire shim tubing	3 each MWTM-85/25-1500/U 3 each MWTM-16/5-1200/U 1 each S1085-3-380 1 each CBR-6-2-A 3 each CBR-PLUG 3 each WCSM-24/6-150-S	MWTM-85/25-A/U MWTM-16/5-A/U S1085-3-380 CBR-6-2-A CBR-PLUG WCSM-24/6-150-S (B50)

Note: MOD-3-HVT kits should be installed prior to installing TE Connectivity HVT kits.

ADDITIONAL PRODUCT INFORMATION

- Standard package: 1 kit/box.
- Kit contents: Unsealed (-3X and -3Y) kits contain re-jacketing tubes for phase and ground conductors, and sealant for indoor terminations that don't require environmental sealing. Sealed (-3A and -3B) kits contain re-jacketing tubes, sealant, a cable breakout, and plugs for both outdoor and indoor terminations.
- Kit components can be purchased in bulk quantities.

HVT-Z-LC/SLC 1/C LC Shield Cable (15kV)

FEATURES

- Reliable, field proven performance.
- Slim profile and lightweight, can be installed upright or inverted.
- Non-tracking material is maintenance free even in highly polluted environments.
- Meets IEEE-48 standard Class 1 termination requirement.

APPLICATIONS

- For 1/C LC Shield Cables between 15 and 35 kV

BENEFITS

- TE's Raychem HVT-Z-LC/SLC heat shrinkable termination are designed using a stress grading material Zinc Oxide (ZnO).
- The use of ZnO as the stress control system has made it possible for us to offer a one piece termination and an overall shorter length than the HVT.
- Unlimited shelf life when stored in normal conditions

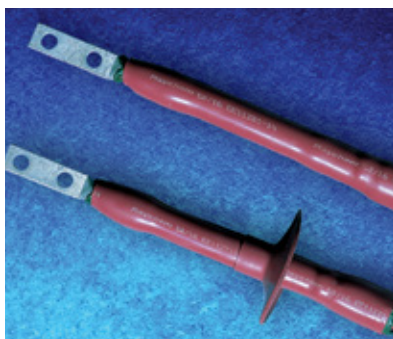

PRODUCT SELECTION INFORMATION: DIMENSIONS IN INCHES (MM)

Catalog Number		Conductor Size (AWG/kcmil)	Min - Max Insulation Diameter	Jacket O.D. (max)
HVT-Z-151-LC	HVT-Z-151-SLC	#4-1/0	0.65-0.95 (5-24)	1.20 (30)
HVT-Z-152-LC	HVT-Z-152-SLC	2/0-350	0.85-1.25 (22-32)	1.50 (38)
HVT-Z-153-LC	HVT-Z-153-SLC	400-1000	1.10-1.75 (28-44)	2.10 (53)
HVT-Z-154-LC	HVT-Z-154-SLC	1250-2500	1.60-2.45 (41-62)	2.75 (70)

ADDITIONAL PRODUCT INFORMATION

- Select the appropriate catalog number. All selections are based on the typical dimensions of 100% insulated and 133% insulated cables manufactured in accordance with the data contained in AEIC CS5 and AEIC CS6 as well as the dimensions of commonly used connectors. Nominal insulation thickness: (100%) 15 kV: 175 mils, 25 kV: 260 mils, 35 kV: 345 mils. Nominal insulation thickness: (133%) 15 kV: 220 mils.
- For cables manufactured to other specifications, confirm selection with cable dimensions.
- HVT-LC/SLC kits are supplied with two pieces of #4 AWG braid to provide fault-current carrying capacity. Users should verify the compatibility of the braids with their LC shield cable.
- Kits do not contain connectors; order compression, ShearBolt, or solder connectors separately.
- For skirt ordering information refer to the Accessory & Tool section.
- Cable Mounting brackets are available to accommodate cable diameters from 0.80-2.40 inches (20-46 mm). Refer to Accessory & Tool section for ordering information.
- Standard package: 1 kit/box
- For testing information refer to the Application and Technical Specification Section.
- Related test reports: Indoor: 15 kV: EDR-5322, Outdoor: 15 kV: EDR-5323

HVT-ZL High Voltage Termination (5 kV - 35 kV)

FEATURES

- Based on the co-extruded, one-piece HVT-Z termination
- When the tubing is shrunk down, the coating softens and sticks to irregular surfaces, providing moisture seals as well as electrical stress control.
- Meet IEEE-48 standard Class 1 termination. High performance, trouble free service under harsh environments.

APPLICATIONS

- TE's Raychem HVT-ZL is intended for applications that require longer installation than HVT-Z kits provide. This may include coastal environments or legacy HVT Termination replacements.

BENEFITS

- The main termination component consists of TE's Raychem non-tracking tube together with a co-extruded stress control grading layer.
- This stress control layer is based on ceramic semi-conductor technology (ZnO) and provides superior discharge and impulse performance.
- Unlimited shelf life when stored in normal conditions

HVT-ZL



TEST REPORTS

Voltage Class	Indoor	Outdoor
5 8 15 kV	EDR-5322	EDR-5323
25 28 35 kV	EDR-5473	EDR-5481

PRODUCT SELECTION INFORMATION: DIMENSIONS IN INCHES (MM)

Catalog Number		Min - Max Conductor Size		Min - Max Insulation Diameter	Jacket O.D. (max)
Indoor	Outdoor Kit				
5/8 kV		5 kV 0.90	8 kV 0.115		
HVT-ZL-80-G	HVT-ZL-80-SG	#4-#1 AWG	#6-#2 AWG	0.35-0.60 (9-15)	0.95 (24)
HVT-ZL-81-G	HVT-ZL-81-SG	1/0-250 kcmil	#1-4/0 AWG	0.60-0.95 (15-24)	1.20 (30)
HVT-ZL-82-G	HVT-ZL-82-SG	300-500 kcmil	250-500 kcmil	0.80-1.25 (20-32)	1.50 (38)
HVT-ZL-83-G	HVT-ZL-83-SG	600-1750 kcmil	600-1750 kcmil	1.10-1.75 (28-44)	2.10 (53)
HVT-ZL-84-G	HVT-ZL-84-SG	1500-2500 kcmil	2000-2500 kcmil	1.60-2.45 (41-62)	2.75 (70)
<i>Installed Length 10.5" (267 mm)</i>					
15 kV		15 kV .175-.220			
HVT-ZL-151-G	HVT-ZL-151-SG	#4-1/0 AWG		0.60-0.95 (15-24)	1.20 (30)
HVT-ZL-152-G	HVT-ZL-152-SG	2/0-350 kcmil		0.80-1.25 (20-32)	1.50 (38)
HVT-ZL-153-G	HVT-ZL-153-SG	400-1000 kcmil		1.10-1.65 (28-44)	2.10 (53)
HVT-ZL-154-G	HVT-ZL-154-SG	1250-2500 kcmil		1.60-2.45 (41-62)	2.75 (70)
<i>Installed Length 15.0" (381 mm)</i>					
25 kV		25 kV 0.260			
HVT-ZL-252-G	HVT-ZL-252-SG	#2-250 kcmil		0.80-1.25 (20-32)	1.50 (38)
HVT-ZL-253-G	HVT-ZL-253-SG	300-750 kcmil		1.10-1.70 (28-43)	2.10 (53)
HVT-ZL-254-G	HVT-ZL-254-SG	1000-2000 kcmil		1.60-2.45 (41-62)	2.75 (70)
<i>Installed Length 28.0" (711 mm)</i>					
35 kV		35 kV 0.345			
HVT-ZL-352-G	HVT-ZL-352-SG	#1-1/0 AWG		0.80-1.25 (20-32)	1.50 (38)
HVT-ZL-353-G	HVT-ZL-353-SG	2/0-500 kcmil		1.10-1.75 (28-44)	2.10 (53)
HVT-ZL-354-G	HVT-ZL-354-SG	750-1750 kcmil		1.60-2.45 (41-62)	2.75 (70)
<i>Installed Length 33.0" (838 mm)</i>					

TEST CHART

Product and Voltage Class Test Description	HVT-Z-80 Series (5-8 kV)	HVT-Z-150 Series (15 kV)	HVT-Z-250 350 Series (25-35 kV)
AC Withstand, 1 minute (kV)	35	60	90
DC Withstand, 15 minutes (kV)	65	75	140
Partial Discharge (min. kV) for 3 pc or less	9	15.6	36
Impulse withstand 1.2 X 50 us, crest kV	95	110	200
Continuous current rating	Equal to cable ampacity		
Wet withstand, 10 seconds, kV rms	30	45	80
Dry withstand, 6 hours, kV rms	25	35	75



HVT/HVT-3 15 kV Terminations

FEATURES

- Fully qualified to applicable sections of IEEE-48 to provide a long, trouble-free product life. In addition, these terminations have been pressure tested to perform at 110°C and 15 psi under load-cycling conditions.

APPLICATIONS

- Accommodates belted or shielded paper-insulated, lead-covered (PILC) or varnished cambric-insulated (VCLC) cable.

BENEFITS

- Proven oil-sealing capabilities with stress-control and non-tracking technologies
- Installs quickly and easily, with no need for special adapters, compound filling, leadwiping, or hot oils



PRODUCT SELECTION INFORMATION: DIMENSIONS IN INCHES (MM)

Catalog Number		Conductor Size (AWG/kcmil)	Insulation Diameter (min)	Max Lead Sheath O.D.	Min Lug O.D.	Min Lug Barrel Length	Installed Length	
Indoor	Outdoor						Indoor	Outdoor
HVT-1590-G/SG 1/C PILC/VCLC Cable								
HVT-1591-G	HVT-1591-SG	#4-2/0	0.60 (15)	0.95 (24)	0.51 (13)	1.50 (38)	22.4 (570)	22.4 (570)
HVT-1592-G	HVT-1592-SG	3/0-400	0.85 (22)	1.25 (32)	0.65 (16)	1.50 (38)	22.4 (570)	22.4 (570)
HVT-1593-G	HVT-1593-SG	400-1000	1.00 (25)	1.65 (42)	0.95 (24)	1.50 (38)	23.6 (600)	23.6 (600)
HVT-1594-G	HVT-1594-SG	1250-2000	1.75 (44)	2.20 (56)	1.25 (32)	1.50 (38)	23.6 (600)	23.6 (600)

Catalog Number		Conductor Size (AWG/kcmil)	Insulation Diameter (min)	Installed Length Indoor		Outdoor	
Indoor	Outdoor			min	max	min	max
HVT-3-1590-G/SG 3/C PILC/VCLC Cable							
HVT-3-1591-G	HVT-3-1591-SG	#4-4/0	0.60 (15)	31.5 (800)	35 (888)	28 (711)	40 (1015)
HVT-3-1592-G	HVT-3-1592-SG	4/0-400	0.85 (22)	31.5 (800)	35 (888)	28 (711)	40 (1015)
HVT-3-1593-G	HVT-3-1593-SG	500-800	1.00 (25)	31.5 (800)	35 (888)	28 (711)	40 (1015)

ADDITIONAL PRODUCT INFORMATION

- Select the appropriate catalog number. Selections are based on the typical dimensions of 100% insulated cables manufactured in accordance with AEIC standard. Nominal insulation thickness (100%): 165 mils
- Lugs are not supplied in the kits and should be ordered separately. Use oil block lugs only.
- Standard package quantity: 1 kit (Each 3/C kit contains all components required to terminate one 3/C PILC cable) per box.
- Related test report: EDR-5472
- Cable mounting brackets are available to accommodate cable diameters from 0.80-4.50 inches (20-115 mm).

HVT-M Flexible Cable Termination (5-25 kV)

FEATURES

- The tubing and molded parts shrink quickly, providing a tight fit and minimizing downtime.
- Meets IEEE-48, standard class 1 termination requirement for indoor or outdoor use: High-voltage, nontracking terminations for standard flexible and mining cables (MP-GC and SHD-GC).

APPLICATIONS

- TE's Raychem HVT-M heat shrinkable terminations for mining cables provide for nontracking termination of 5-25 kV MP-GC and SHD-GC flexible cables.

BENEFITS

- Proven, nontracking insulation surface can withstand the rigors of long-term electrical stress and surface pollution while maintaining its overall performance.
- For outdoor applications in polluted and dusty environments, the creepage path is quickly extended by simply installing heat shrinkable skirts.



PRODUCT SELECTION INFORMATION: DIMENSIONS IN INCHES (MM)

Catalog Number		Power Conductor Size (AWG/kcmil)			
Indoor	Outdoor	5 kV		8 kV	
		3/C MP-GC	3/C SHD-GC	3/C MP-GC	3/C SHD-GC
5-8 kV					
HVT-M-581	HVT-M-581-S	#2-3/0	#6-2/0	#4-2/0	#4-#1
HVT-M-582	HVT-M-582-S	4/0-350	3/0-300	3/0-350	1/0-300
HVT-M-583	HVT-M-583-S	500-750	350-500	500-750	350-500
15 kV					
HVT-M-151	HVT-M-151-S	#2-4/0	#2-3/0		
HVT-M-152	HVT-M-152-S	250-500	4/0-500		
25 kV					
HVT-M-251	HVT-M-251-S	#1-250	#1-4/0		
HVT-M-252	HVT-M-252-S	350-500	250-500		

ADDITIONAL PRODUCT INFORMATION

- Select the appropriate catalog number based on conductor size for your cable type. Confirm selection with cable diameter range.
- Kits do not contain connectors; please order separately.
- "S" (outdoor) kits include skirts (rain sheds).
- For longer tail lengths or for cable types not listed in this catalog, contact your local TE representative.
- Standard package: One 3/C kit/box.
- Related test reports: 5/8 kV: EDR-5217, 15 kV: EDR-5218, 25 kV: EDR-5219
- Cable mounting brackets are available to accommodate cable diameters from 0.80-4.50 inches (20-115 mm).

CST Cold Shrink Terminations

FEATURES

- Spiral holdout with pull direction toward the lug provides easy installation
- Extra-long, integrated geometric stress control and void-filling mastic to reduce termination positioning errors
- Outstanding weathering, UV and ozone resistance
- Chemical-resistant and fungus-resistant
- Hydrophobic silicone material to repel water
- Meet IEEE-48 standard class 1 requirements.

APPLICATIONS

- TE's raychem CST cold applied termination for polymeric shielded cables up to 35 kV with JCN, copper tape, wire, LC and Flat strap metallic shields. Indoor and outdoor applications included.

BENEFITS

- ♦ Reliable, easy to install system to ensure trouble free service
- ♦ All components are pre-expanded on an easy-to-remove spiral holdout, allowing installation in compact environments on prepared cable.
- ♦ Shear Bolt and compression style terminals and pin connectors are available to provide reliable connection to a variety of conductors.

PRODUCT SELECTION INFORMATION: DIMENSIONS IN INCHES (MM)

Catalog Number*	Cable Range (AWG/kcmil)	Min - Max Insulation Diameter	Number of Skirts	Std. Pack (Kits/Box)
Shielded, Indoor (5/8 kV) Range is for 5/8kV 100% insulation				
CSTI-152	2/0-350 kcmil	0.65 - 1.06 in (16.5 - 27.0 mm)	3	1
CSTI-153	500-750 kcmil	0.97 - 1.35 in (24.5 - 34.5 mm)	3	1
CSTI-154	1000 kcmil	1.28 - 2.04 in (32.5 - 52.0 mm)	3	1
CSTIL-154	1000 kcmil	1.28 - 2.04 in (32.5 - 52.0 mm)	3	1
Shielded, Outdoor (5/8 kV) Range is for 5/8kV 100% insulation				
CSTO-152	2/0-350 kcmil	0.65 - 1.06 in (16.5 - 27.0 mm)	4	1
CSTO-153	500-750 kcmil	0.97 - 1.35 in (24.5 - 34.5 mm)	4	1
CSTO-154	1000 kcmil	1.28 - 2.04 in (32.5 - 52.0 mm)	4	1
CSTOL-154	1000 kcmil	1.28 - 2.04 in (32.5 - 52.0 mm)	4	1
Shielded, Indoor (15kV) Range is for 15kV 100% insulation				
CSTI-152	#2 - 250 kcmil	0.65 - 1.06 in (16.5 - 27.0 mm)	3	1
CSTI-153	350 - 500 kcmil	0.97 - 1.35 in (24.5 - 34.5 mm)	3	1
CSTI-154	600 - 1250 kcmil	1.28 - 2.04 in (32.5 - 52.0 mm)	3	1
CSTIL-154	600 - 1250 kcmil	1.28 - 2.04 in (32.5 - 52.0 mm)	3	1
Shielded, Outdoor (15kV) Range is for 15kV 100% insulation				
CSTO-152	#2 - 250 kcmil	0.65 - 1.06 in (16.5 - 27.0 mm)	4	1
CSTO-153	350 - 500 kcmil	0.97 - 1.35 in (24.5 - 34.5 mm)	4	1
CSTO-154	600 - 1250 kcmil	1.28 - 2.04 in (32.5 - 52.0 mm)	4	1
CSTOL-154	600 - 1250 kcmil	1.28 - 2.04 in (32.5 - 52.0 mm)	4	1
Shielded, Indoor (25/28kV) Range is for 25kV 100% insulation				
CSTI-282	#1 - 2/0	0.65 - 1.06 in (16.5 - 27.0 mm)	3	1
CSTI-283	2/0 - 350 kcmil	0.97 - 1.35 in (24.5 - 34.5 mm)	3	1
CSTI-284	500 - 1250 kcmil	1.28 - 2.04 in (32.5 - 52.0 mm)	3	1
CSTIL-284	500 - 1250 kcmil	1.28 - 2.04 in (32.5 - 52.0 mm)	3	1
Shielded, Outdoor (25/28kV) Range is for 25kV 100% insulation				
CSTO-282	#1 - 2/0	0.65 - 1.06 in (16.5 - 27.0 mm)	4	1
CSTO-283	2/0 - 350 kcmil	0.97 - 1.35 in (24.5 - 34.5 mm)	4	1
CSTO-284	500 - 1250 kcmil	1.28 - 2.04 in (32.5 - 52.0 mm)	4	1
CSTOL-284	500 - 1250 kcmil	1.28 - 2.04 in (32.5 - 52.0 mm)	4	1
Shielded, Indoor (35kV) Range is for 35kV 100% Insulation				
CSTI-352	1/0 - 350 kcmil	0.95 - 1.41 in (24.3 - 36.0 mm)	7	1
CSTI-353	250 - 750 kcmil	1.27 - 1.89 in (32.4 - 48.0 mm)	7	1
CSTI-354	750 - 2000 kcmil	1.70 - 2.52 in (43.2 - 64.0 mm)	7	1
Shielded, Outdoor (35kV) Range is for 35kV 100% Insulation				
CSTO-352	1/0 - 350 kcmil	0.95 - 1.41 in (24.3 - 36.0 mm)	8	1
CSTO-353	250 - 750 kcmil	1.27 - 1.89 in (32.4 - 48.0 mm)	8	1
CSTO-354	750 - 2000 kcmil	1.70 - 2.52 in (43.2 - 64.0 mm)	8	1

* For JCN, add a J at the end of the part description. Example: CSTI-152 becomes CSTI-152J
For other shielded cables, add a G at the end of the part description. Example: CSTO-153 becomes CSTO-153G

CST - Outdoor



PRODUCT SELECTION INFORMATION: DIMENSIONS IN INCHES (MM)

CST Accessory Options

CSTO L** -153J -SL2 -B2

Connector Code	Type	Use Range	Size
blank	no connector included		
-CP0	Compression pin (12 inches)		#2
-CP1	Compression pin (12 inches)		#1
-CP2	Compression pin (12 inches)		1/0
-CP3	Compression pin (12 inches)		2/0
-CP4	Compression pin (12 inches)		3/0
-CP5	Compression pin (12 inches)		4/0
-CLO	Copper Compression lug		#2
-CL1	Copper Compression lug		#1
-CL2	Copper Compression lug		1/0
-CL3	Copper Compression lug		2/0
-CL4	Copper Compression lug		3/0
-CL5	Copper Compression lug		4/0
-CL6	Copper Compression lug		350
-CL7	Copper Compression lug		500
-CL8	Copper Compression lug		750
-CL9	Copper Compression lug		1000
-SLO	Aluminum Shearbolt lug	.268-.528	#2-4/0
-SL1	Aluminum Shearbolt lug	.268-.681	#2-350
-SL2	Aluminum Shearbolt lug	.616-.998	350-750**
-SL3	Aluminum Shearbolt lug	.813-1.152	600-1000**

Bracket

Code	T	Use Range (in)	Size
blank		not included	N/A
-B1		0.80-1.25	straight
-B2		1.10-1.50	straight
-B3		1.45-1.95	straight
-B4		1.80-2.40	straight
-B5		0.80-1.25	90 degree
-B6		1.10-1.50	90 degree
-B7		1.45-1.95	90 degree
-B8		1.80-2.40	90 degree

Contact TE customer support (or equivalent) for other connectors, as TE offers other sizes, lengths, and types.

**These size connectors must be used with long neck type CST except for 35 kV part numbers. Aluminum connectors are tin plated and can be used on copper or aluminum conductors. Compression and shear bolt connectors are 2-hole NEMA type.

ADDITIONAL PRODUCT INFORMATION

- Selections are based in the typical dimensions of Concentric-Stranded insulated cables and the dimensions of commonly used connectors manufactured in accordance with AEIC standard. Nominal insulation thicknesses: 15 kV 100% (175 mils), 15 kV 133% (220 mils), 25 kV 100% (260 mils), 35 kV (345 mils).
- For cables manufactured to other specifications, confirm selection with cable dimensions.
- Test Report available EDR-5591, EDR-5629.

MOD-3-CST Medium Voltage Cold Shrink Terminations (CST)

FEATURES

- Cold applied design
- High tracking, erosion, and UV resistant
- Retains performance over wide temperature range -45° to +150° C
- 3/C modification kit

APPLICATIONS

- TE's Raychem MOD-3-CST cold shrink termination converts a 3 conductor cable to 3 single conductor cables when terminating medium voltage power cable

BENEFITS

- ♦ Easy release spiral holdout for fast installation
- ♦ Superior moisture and environmental sealing



PRODUCT SELECTION INFORMATION: DIMENSIONS IN INCHES (MM)

Catalog Number	CST Kit Insulation Diameter Use Range	CST Application Diameter Use Range for MOD Kit	Description	Single Conductor Insulation Diameter Use Range	Overall Cable Jacket Diameter Use Range
Indoor CST Kit					
CST-152, CST-282	0.65 - 1.06(16.5-27.0)	0.65 - 0.90(16.5-22.9)	MOD-3B-CSTI	0.62 - .90 (15.7 - 22.9)	--
CST-152, CST-282	0.65 - 1.06(16.5-27.0)	0.91 - 1.06(23.1-27.0)	MOD-3C-CSTI	0.90 - 1.08 (22.9 - 27.4)	--
CST-153, CST-283	0.97 - 1.35(24.5-34.5)	0.97 - 1.08(24.4-34.5)	MOD-3C-CSTI	0.90 - 1.08 (22.9- 27.4)	--
CST-153, CST-283	0.97 - 1.35(24.5-34.5)	1.09 - 1.35(27.7-34.5)	MOD-3D-CSTI	1.08 - 1.36 (27.4 - 34.5)	--
CST-154, CST-284	1.28 - 2.04(32.5-52.0)	1.37 - 2.04(34.8-52.0)	MOD-3E-CSTI	1.18 - 2.54 (30.0 - 64.5)	--
CST-352	0.95-1.41(24.3-36.0)	0.95-1.08(24.3-27.4)	MOD-3C-CSTI	0.90 - 1.08 (22.9 - 27.4)	--
CST-352	0.95-1.41(24.3-36.0)	1.09-1.36(27.7-34.5)	MOD-3D-CSTI	1.08 - 1.36 (27.4 - 34.5)	--
CST-352	0.95-1.41(24.3-36.0)	1.37-1.41(34.8-36.0)	MOD-3E-CSTI	1.18 - 2.54 (30.0 - 64.5)	--
CST-353	1.27-1.89(32.4-48.0)	1.27-1.89(32.4-48.0)	MOD-3E-CSTI	1.18 - 2.54 (30.0 - 64.5)	--
CST-354	1.70-2.52(43.2-64.0)	1.70-2.52(43.2-64.0)	MOD-3E-CSTI	1.18 - 2.54 (30.0 - 64.5)	--
Outdoor CST Kit					
CST-152, CST-282	0.65 - 1.06(16.5-27.0)	0.65 - 0.90(16.5-22.9)	MOD-3B-CSTO	0.62 - .90 (15.7 - 22.9)	2.21 - 3.23 (51.6 - 82)
CST-152, CST-282	0.65 - 1.06(16.5-27.0)	0.91 - 1.06(23.1-27.0)	MOD-3C-CSTO	0.90 - 1.08 (22.9 - 27.4)	2.50 - 3.74 (63.6 - 95)
CST-153, CST-283	0.97 - 1.35(24.5-34.5)	0.97 - 1.08(24.4-34.5)	MOD-3C-CSTO	0.90 - 1.08 (22.9- 27.4)	2.50 - 3.74 (63.6 - 95)
CST-153, CST-283	0.97 - 1.35(24.5-34.5)	1.09 - 1.35(27.7-34.5)	MOD-3D-CSTO	1.08 - 1.36 (27.4 - 34.5)	2.93 - 4.33 (74.4 - 110)
CST-154, CST-284	1.28 - 2.04(32.5-52.0)	1.37 - 2.04(34.8-52.0)	MOD-3E-CSTO	1.18 - 2.54 (30.0 - 64.5)	3.21 - 5.90 (81.6 - 150)
CST-352	0.95-1.41(24.3-36.0)	0.95-1.08(24.3-27.4)	MOD-3C-CSTO	0.90 - 1.08 (22.9 - 27.4)	2.50 - 3.74 (63.6 - 95)
CST-352	0.95-1.41(24.3-36.0)	1.09-1.36(27.7-34.5)	MOD-3D-CSTO	1.08 - 1.36 (27.4 - 34.5)	2.93 - 4.33 (74.4 - 110)
CST-352	0.95-1.41(24.3-36.0)	1.37-1.41(34.8-36.0)	MOD-3E-CSTO	1.18 - 2.54 (30.0 - 64.5)	3.21 - 5.90 (81.6 - 150)
CST-353	1.27-1.89(32.4-48.0)	1.27-1.89(32.4-48.0)	MOD-3E-CSTO	1.18 - 2.54 (30.0 - 64.5)	3.21 - 5.90 (81.6 - 150)
CST-354	1.70-2.52(43.2-64.0)	1.70-2.52(43.2-64.0)	MOD-3E-CSTO	1.18 - 2.54 (30.0 - 64.5)	3.21 - 5.90 (81.6 - 150)

Indoor kits include 6 - 15 inch re-jacketing sleeves, two per phase, sealing mastic

Outdoor kits include 6 - 15 inch long re-jacketing sleeves, two per phase, crotch sealing boot, sealing mastic and solder blocked ground braid. Each kit contains easy to follow product installation instructions with visual displays of the installation steps. Installation is fast and simple.

ADDITIONAL PRODUCT INFORMATION

- To select the appropriate CST-MOD kit for the CST terminations, find the CST termination kit being used in the selection table above for indoor or outdoor application.
- Verify that the cable insulation diameter falls within the single conductor insulation diameter use range for the indoor MOD-CST kit. For outdoor MOD-CST kits selection, also verify the 3/C cable overall diameter falls within the overall cable jacket diameter use range.

TFT-E 1/C Termination for Shielded Power Cable

FEATURES

- Holdout tube prevents collapsing due to rough handling
- Quick and easy installation in confined spaces
- Seals out moisture and contamination
- Aluminum shear bolts are available in 35 kV class terminations
- Fully qualified class 1 termination per IEEE-48 for a long, trouble free service life.

APPLICATIONS

- This termination features an advanced stress control system using metal oxide matrix technology providing superior electrical performance.
- Material does not degrade in outdoor applications

BENEFITS

- ♦ TE's Raychem TFT-E system has an elastomeric housing with integral sheds that is formulated for long term performance in typical extreme termination environments. The housing comes on a pre-lubricated, crush resistant holdout for simple installation. The superior elastomeric housing, together with the positively positioned stress control system and moisture sealing mastic, provide reliable and consistent installations.
- ♦ Provides excellent electrical performance and prevents misplacement of stress control system

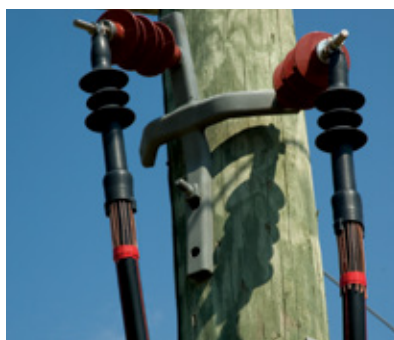

Insulation Class	6 h AC	DEV	BIL	DC
15 kV	35 kV	13 kV	110 kV	75 kV
25 kV	55 kV	21.5 kV	150 kV	105 kV
35 kV	75 kV	30 kV	200 kV	140 kV

PRODUCT SELECTION INFORMATION: DIMENSIONS IN INCHES (MM)

Catalog Number	Nominal Conductor Size	Min/Max Insulation O.D.s*
TFT-151E-SG-SLC	#2-250 kcmil	0.64-1.09 (16-28)
TFT-152E-SG-SLC	4/0-500 kcmil	0.85-1.45 (22-37)
TFT-153E-SG-SLC	500-750 kcmil	1.06-1.70 (27-43)
TFT-154E-SG-SLC	1000-1250 kcmil	1.49-2.20 (38-56)
TFT-251E-SG-SLC	#1-2/0 AWG	0.64-1.09 (16-28)
TFT-252E-SG-SLC	#2-350 kcmil	0.85-1.45 (22-37)
TFT-253E-SG-SLC	250-750 kcmil	1.06-1.70 (27-46)
TFT-254E-SG-SLC	750-1250 kcmil	1.49-2.20 (38-63)
TFT-352E-SG-SLC	1/0-250 kcmil	0.85-1.45 (22-37)
TFT-353E-SG-SLC	4/0-350 kcmil	1.06-1.70 (27-43)
TFT-354E-SG-SLC	500-1250 kcmil	1.49-2.20 (38-56)

*Insulation ODs and nominal conductor sizes are based on 100 and 133% concentric stranded cable dimensions.

Kit	Nominal Conductor Size	Min./Max. Insulation O.D.	Connector
TFT-353E-T5	1/0-350	1.05-1.48 (26-38)	ASBT-2-350
TFT-354E-T8	350-750	1.36-1.82 (35-46)	ASBT-350-750
TFT-354E-T9	600-1000	1.57-2.20 (40-56)	ASBT-600-1000

ADDITIONAL PRODUCT INFORMATION

- The -SG and -SLC kits contain a solder-blocked ground braid and a solderless ground clamp.
- Select the appropriate catalog number. Selections are based on the typical dimensions of 100% insulated cables and the dimensions of commonly used connectors manufactured in accordance with AEIC standard. Nominal insulation thickness (100%): 15 kV: 175 mils, 25 kV: 260 mils, 35 kV: 345 mils.
- For cables manufactured to other specifications, confirm selection with cable dimensions.
- Kits do not contain connectors; order compression or solder connectors separately.
- Cable mounting brackets are available to accommodate cable diameters from 0.80-2.40 inches (20-61 mm).

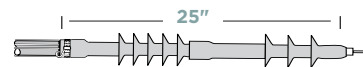
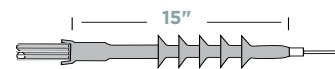
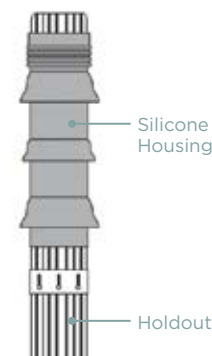

PRODUCT SELECTION INFORMATION: DIMENSIONS IN INCHES (MM)

Catalog Number	Cable Range (AWG/kcmil)	Min - Max Insulation Diameter	Number of Skirts	Standard Pack (kits/box)	Hold Out ID
CN and JCN Cable - Indoor/Outdoor (15 kV)					
TFT-151E	#2-250	0.64-1.09 (16-28)	3	1 ea.	1.50 (38)
TFT-152E	4/0-500	0.85-1.45 (22-37)	3	1 ea.	1.77 (45)
TFT-153E	500-750	1.06-1.70 (27-43)	3	1 ea.	2.09 (53)
TFT-154E	1000-1250	1.49-2.20 (38-56)	3	1 ea.	2.56 (65)
CN and JCN Cable - Indoor/Outdoor (25 kV)					
TFT-251E	#1-3/0	0.64-1.09 (16-28)	5	1 ea.	1.50 (38)
TFT-252E	#1-500	1.85-1.45 (22-37)	5	1 ea.	1.77 (45)
TFT-253E	250-750	1.60-1.70 (27-43)	5	1 ea.	2.09 (53)
TFT-254E	750-1250	1.49-2.20 (38-56)	5	1 ea.	2.56 (65)
CN and JCN Cable - Indoor/Outdoor (35 kV)					
TFT-352E	1/0-40	.85-1.31 (22-33)	8	1 ea.	1.77 (45)
TFT-353E	4/0-500	1.06-1.70 (27-43)	8	1 ea.	2.09 (53)
TFT-354E	500-1250	1.49-2.20 (38-56)	8	1 ea.	2.56 (65)
Tape Shielded Cable - Indoor/Outdoor (5 kV No Sheds)					
TFT-151E-G	2/0-250	0.64-1.09 (16-28)	0	3 ea.	1.50 (38)
TFT-152E-G	350-500	0.85-1.45 (22-37)	0	3 ea.	1.77 (45)
TFT-153E-G	500-750	1.06-1.70 (27-43)	0	3 ea.	2.09 (53)
Tape Shielded Cable - Indoor/Outdoor (8 kV No Sheds)					
TFT-151E-G	1/0-250	0.64-1.09 (16-28)	0	3 ea.	1.50 (38)
TFT-152E-G	250-500	0.85-1.45 (22-37)	0	3 ea.	1.77 (45)
TFT-153E-G	500-750	1.06-1.70 (27-43)	0	3 ea.	2.09 (53)
Tape Shielded Cable - Indoor Only (15 kV No Sheds)					
TFT-151E-G	#2-250	0.64-1.09 (16-28)	0	3 ea.	1.50 (38)
TFT-152E-G	4/0-500	0.85-1.45 (22-37)	0	3 ea.	1.77 (45)
TFT-153E-G	500-750	1.06-1.70 (27-43)	0	3 ea.	2.09 (53)
Tape Shielded Cable - Indoor/Outdoor (15 kV)					
TFT-151E-SG	#2-250	0.64-1.09 (16-28)	3	3 ea.	1.50 (38)
TFT-152E-SG	4/0-500	0.85-1.45 (22-37)	3	3 ea.	1.77 (45)
TFT-153E-SG	500-750	1.06-1.70 (27-43)	3	3 ea.	2.09 (53)
TFT-154E-SG	1000-1250	1.49-2.20 (38-56)	3	3 ea.	2.56 (65)
Tape Shielded Cable - Indoor/Outdoor (25 kV)					
TFT-251E-SG	#1-3/0	0.64-1.09 (16-28)	5	3 ea.	1.50 (38)
TFT-252E-SG	#	0.85-1.45 (22-37)	5	3 ea.	1.77 (45)
TFT-253E-SG	250-750	1.06-1.70 (27-43)	5	3 ea.	2.09 (53)
TFT-254E-SG	750-1250	1.49-2.20 (38-56)	5	3 ea.	2.56 (65)
Tape Shielded Cable - Indoor/Outdoor (35 kV)					
TFT-352E-SG	1/0-250	0.85-1.45 (22-37)	8	3 ea.	1.77 (45)
TFT-353E-SG	4/0-500	1.06-1.70 (27-43)	8	3 ea.	2.09 (53)
TFT-354E-SG	500-1250	1.49-2.20 (38-56)	8	3 ea.	2.56 (65)
LC Shielded Cable - Indoor/Outdoor (15 kV)					
TFT-151E-SLC	#2-250	0.64-1.09 (16-28)	3	3 ea.	1.50 (38)
TFT-152E-SLC	4/0-500	0.85-1.45 (22-37)	3	3 ea.	1.77 (45)
TFT-153E-SLC	500-750	1.06-1.70 (27-43)	3	3 ea.	2.09 (53)
TFT-154E-SLC	1000-1250	1.49-2.20 (38-56)	3	3 ea.	2.56 (65)
LC Shielded Cable - Indoor/Outdoor (25 kV)					
TFT-251E-SLC	#1-3/0	0.64-1.09 (16-28)	5	3 ea.	1.50 (38)
TFT-252E-SLC	#	0.85-1.45 (22-37)	5	3 ea.	1.77 (45)
TFT-253E-SLC	250-750	1.06-1.70 (27-43)	5	3 ea.	2.09 (53)
TFT-254E-SLC	750-1250	1.49-2.20 (38-56)	5	3 ea.	2.56 (65)
LC Shielded Cable - Indoor/Outdoor (35 kV)					
TFT-352E-SLC	1/0-250	0.85-1.45 (22-37)	8	3 ea.	1.77 (45)
TFT-353E-SLC	4/0-500	1.06-1.70 (27-43)	8	3 ea.	2.09 (53)
TFT-354E-SLC	500-1250	1.49-2.20 (38-56)	8	3 ea.	2.56 (65)

RELATED INFORMATION

Test Report:
EDR-5302, 15 kV
EDR-5303, 25 kV
EDR-5357, 35 kV
EDR-5299

- 1 Packaging: Standard packaging is three terminations per box
- 2 Available accessories: The BRKT series of stainless steel cable mounting brackets are available. Four sizes of brackets accommodate cable diameters from 0.80-2.40 inches (20-61 mm) 3 conductor modification kits.
- 3 Lugs and pin terminals also available.

Installed Length
5/8/15 kV (without sheds)

L = 10.5"



15 kV (with sheds)

L = 11.5"



25 kV (with sheds)

L = 15"



35 kV (with sheds)

L = 25"



TFT-R 1/C Terminations for Shielded / Non-Shielded Power Cable

FEATURES

- Advanced Metal Oxide Matrix stress control
- Provided on a crush-resistant core
- Fully qualified class 1 termination per IEEE-48 for a long, trouble free service life.

APPLICATIONS

- Have been developed to provide a quick and easy, cold-applied method of terminating 5-35 kV, single conductor polymeric cables.
- TE's Raychem TFT-R and TFT-R-SG are designed for indoor and outdoor conditions.
- TE's Raychem TFT-R kits are for non-shielded cable applications. TFT-R-G kits do not have rain sheds and should be used for 5/8 kV indoor or outdoor applications and 15 kV indoor only applications.

BENEFITS

- Easy installation — allows for repositioning
- Positive placement of stress control patch allowing inversion installs if necessary

PRODUCT SELECTION INFORMATION: DIMENSIONS IN INCHES (MM)

Catalog Number	Cable Range (AWG/kcmil)	Insulation Diameter (min - max)	Number of Skirts	Standard Pack (kits/box)
TFT-P-R Tape Shielded, Indoor - Push on Installation (5 kV/8 kV)				
TFT-P-80R	#6 - #2 AWG	0.39 - 0.61 (10-16)	0	3
TFT-R Non-Shielded, Indoor/Outdoor - Without Sheds (5 kV)				
TFT-50R	#2-3/0 AWG	0.53-0.80 (13-20)	0	3
TFT-51R	1/0-250 kcmil	0.64-1.09 (16-28)	0	3
TFT-52R	250-500 kcmil	0.85-1.45 (22-37)	0	3
TFT-53R	350-750 kcmil	1.06-1.70 (27-43)	0	3
TFT-R-G Tape Shielded, Indoor/Outdoor - Without Sheds (5 kV)				
TFT-150R-G	#2-3/0 AWG	0.53-0.80 (13-20)	0	3
TFT-151R-G	2/0-250 kcmil	0.64-1.09 (16-28)	0	3
TFT-152R-G	350-500 kcmil	0.85-1.45 (22-37)	0	3
TFT-153R-G	500-750 kcmil	1.06-1.70 (27-43)	0	3
TFT-R-G Tape Shielded, Indoor/Outdoor - Without Sheds (8 kV)				
TFT-150R-G	#2-3/0 AWG	0.53-0.80 (13-20)	0	3
TFT-151R-G	1/0-250 kcmil	0.64-1.09 (16-28)	0	3
TFT-152R-G	250-500 kcmil	0.85-1.45 (22-37)	0	3
TFT-153R-G	500-750 kcmil	1.06-1.70 (27-43)	0	3
TFT-R-G Tape Shielded, Indoor Only - Without Sheds (15 kV)				
TFT-150R-G	#2-3/0 AWG	0.53-0.80 (13-20)	0	3
TFT-151R-G	#2-250 kcmil	0.64-1.09 (16-28)	0	3
TFT-152R-G	4/0-500 kcmil	0.85-1.45 (22-37)	0	3
TFT-153R-G	500-750 kcmil	1.06-1.70 (27-43)	0	3
TFT-R-SG Tape Shielded, Indoor/Outdoor (15 kV)				
TFT-151R-SG	#2-250 kcmil	0.64-1.09 (16-28)	3	3
TFT-152R-SG	4/0-500 kcmil	0.85-1.45 (22-37)	3	3
TFT-153R-SG	500-750 kcmil	1.06-1.70 (27-43)	3	3
TFT-154R-SG	1000-1250 kcmil	1.49-2.20 (38-56)	3	3
TFT-R-SG Tape Shielded, Indoor/Outdoor (25 kV)				
TFT-251R-SG	#1-3/0 AWG	0.64-1.09 (16-28)	5	3
TFT-252R-SG	#2/0-500 kcmil	0.85-1.45 (22-37)	5	3
TFT-253R-SG	250-750 kcmil	1.06-1.70 (27-43)	5	3
TFT-254R-SG	750-1250 kcmil	1.49-2.20 (38-56)	5	3
TFT-R-SG Tape Shielded, Indoor/Outdoor (35 kV)				
TFT-352R-SG	1/0-250 kcmil	0.85-1.45 (22-37)	8	3
TFT-353R-SG	4/0-500 kcmil	1.06-1.70 (27-43)	8	3
TFT-354R-SG	500-1250 kcmil	1.49-2.20 (38-56)	8	3



4

Installed Length
5/8/15 kV (without sheds)



15 kV (with sheds)



25 kV (with sheds)



35 kV (with sheds)



ADDITIONAL PRODUCT INFORMATION

- All shielded cable kits contain a solder-blocked ground braid and a solderless ground clamp.
- Selections are based on the typical dimensions of 100% insulated cables and the dimensions of commonly used connectors manufactured in accordance with AEIC standard. Nominal insulation thickness (100%): 15 kV: 175 mils, 25 kV: 260 mils, 35 kV: 345 mils
- For cables manufactured to other specifications, confirm cable dimensions.
- Kits do not contain connectors; order compression or solder connectors separately.
- Related test reports: 15 kV: EDR-5302 (outdoor), 15 kV: EDR-5306 (indoor), 25 kV: EDR-5303, EDR-5357, 35 kV: EDR-5299
- Cable mounting brackets are available to accommodate cable diameters from 0.80-2.40 inches (20-61 mm).
- For three conductor cables, order MOD-3-TFT kits.

CSJD Cold Shrink Disconnectable Joint

FEATURES

- Pre-expanded EPDM re-jacketing sleeve and integrated neutral sock provide easy installation
- Joint body, jacket seal and copper neutral sock integrated into a single unit
- Ergonomically designed spiral holdout provides smooth installation with low release forces
- Meets IEEE 404 (2012) requirements for 15/28 kV
- CSJD kits include copper or aluminum shear bolt connectors and shear head bus bolts.

APPLICATIONS

- TE's Raychem CSJD, cold shrinkable disconnectable joint for 15 kV through 28 kV is designed to connect tape shield, LC shield, JCN and flat strap shielded cables to standard 'I', 'Y' and 'H' insulated cable buses.

BENEFITS

- No cable adapter or retaining rings needed because of the cold shrinkable range-taking design.
- The flexible silicone rubber joint body combined with an integrated EPDM jacket provides a tight moisture seal that remains secure, even when the joint is bent or moved.
- Submersible secondary joint.



Sleeve Restraint-D

TE's unique sleeve restraint secures a molded disconnectable joint to the bus when a CSJD is installed in an opposing position.



CSJD-Removal Tool

This tool makes removal of a CSJD disconnectable joint safe and easy, without risk of damaging the cable.

PRODUCT SELECTION INFORMATION: DIMENSIONS IN INCHES (MM)

Voltage Class	Catalog Number	Nominal Cable Range	Min/Max Insulation O.D.	Max Jacket O.D.	Neutral Sock (AWG)	Min/Max Diameter Over Cable Conductor*	Kit Installed Length	Required Installation Space
Disconnectable Joint with Aluminum Mechanical Shear Bolt Connector								
15 kV	CSJD-1521-A1	#2 - 350	0.69 - 1.20 (17.5 - 30.5)	1.50 (38.1)	1/0	0.268 - 0.681 (6.8 - 17.3)	24 (610)	33 (838)
15 kV	CSJD-1523-A2	350 - 750	1.03 - 1.58 (26.2 - 40.0)	2.05 (52.1)	1/0	0.616 - 0.998 (15.7 - 25.4)	24 (610)	33 (838)
15 kV	CSJD-1524-A3	750 - 1000	1.28 - 2.05 (32.5 - 52.0)	2.60 (66.0)	2/0	0.813 - 1.252 (20.7 - 29.3)	24 (610)	33 (838)
28 kV	CSJD-2821-A1	#2 - 4/0	0.69 - 1.20 (17.5 - 30.5)	1.50 (38.1)	2/0	0.268 - 0.681 (6.8 - 17.3)	24 (610)	33 (838)
28 kV	CSJD-2823-A1	4/0 - 350	1.03 - 1.58 (26.2 - 40.0)	2.05 (52.1)	2/0	0.268 - 0.681 (6.8 - 17.3)	24 (610)	33 (838)
28 kV	CSJD-2823-A2	350 - 750	1.03 - 1.58 (26.2 - 40.0)	2.05 (52.1)	2/0	0.616 - 0.998 (15.7 - 25.4)	24 (610)	33 (838)
28 kV	CSJD-2824-A2	500 - 750	1.28 - 2.05 (32.5 - 52.0)	2.60 (66.0)	2/0	0.616 - 0.998 (15.7 - 25.4)	24 (610)	33 (838)
28 kV	CSJD-2824-A3	750 - 1000	1.28 - 2.05 (32.5 - 52.0)	2.60 (66.0)	2/0	0.813 - 1.252 (20.7 - 29.3)	24 (610)	33 (838)
* Min/max diameter over cable conductor accepted by the aluminum mechanical connector.								
Disconnectable Joint with Copper Mechanical Shear Bolt Connector								
15 kV	CSJD-1521-C1	#2 - 4/0	0.69 - 1.20 (17.5 - 30.5)	1.50 (38.1)	2/0	0.268 - 0.528 (6.8 - 13.4)	24 (610)	33 (838)
15 kV	CSJD-1521-C2	4/0 - 350	0.69 - 1.20 (17.5 - 30.5)	1.50 (38.1)	2/0	0.376 - 0.813 (9.6 - 20.7)	24 (610)	33 (838)
15 kV	CSJD-1523-C3	300 - 750	1.03 - 1.58 (26.2 - 40.0)	2.05 (52.1)	2/0	0.570 - 0.998 (14.5 - 25.3)	24 (610)	33 (838)
15 kV	CSJD-1524-C4	500 - 1000	1.28 - 2.05 (32.5 - 52.0)	2.60 (66.0)	2/0	0.736 - 1.152 (18.7 - 29.30)	24 (610)	33 (838)
28 kV	CSJD-2821-C1	#2 - 4/0	0.69 - 1.20 (17.5 - 30.5)	1.50 (38.1)	2/0	0.268 - 0.528 (6.8 - 13.4)	24 (610)	33 (838)
28 kV	CSJD-2823-C2	4/0 - 500	1.03 - 1.58 (26.2 - 40.0)	2.05 (52.1)	2/0	0.376 - 0.813 (9.6 - 20.7)	24 (610)	33 (838)
28 kV	CSJD-2823-C3	300 - 750	1.03 - 1.58 (26.2 - 40.0)	2.05 (52.1)	2/0	0.570 - 0.998 (14.5 - 25.3)	24 (610)	33 (838)
28 kV	CSJD-2824-C4	500 - 1000	1.28 - 2.05 (32.5 - 52.0)	2.60 (66.0)	2/0	0.736 - 1.152 (18.7 - 29.30)	24 (610)	33 (838)
* Min/max diameter over cable conductor accepted by the copper mechanical connector.								

ADDITIONAL PRODUCT INFORMATION

- Selections are based on the typical dimensions of 100% insulated cables, manufactured in accordance with AEIC standard.
- Nominal insulation thickness (100%): 15 kV:175mils, 25 kV:260mils.
- Select the appropriate catalog number. Use the insulation O.D., and jacket O.D. range as the final ordering criteria.
- For other applications or if you have any questions, contact your TE representative.
- Standard package: 1 kit per box.
- Related test reports: EDR-5582

CATJ Cold Applied Transition Joint

FEATURES

- Easy to install lead seal and connector seal
- All-in-One design pre-expanded silicone joint body with integrated neutral socket and re-jacketing
- Cold applied oil barrier tube requires no special restricting tapes
- Range-taking oil stop shear bolt connectors supplied within the kit

APPLICATIONS

- TE's Raychem CATJ cold applied joint for 1/C PILC cables to 1/C solid dielectric cables

BENEFITS

- ♦ The CATJ joints offer a reliable, robust and easy-to-install cold applied transition jointing system.
- ♦ CATJ cold applied transition joints are designed to cover a wide range of applications and to accommodate the variety of cable and conductor types.

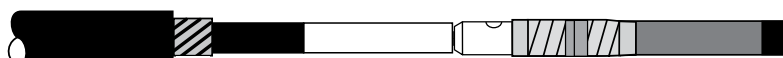
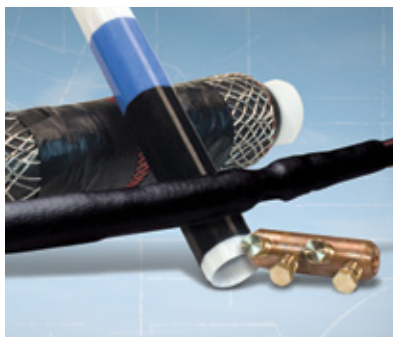

PRODUCT SELECTION INFORMATION: DIMENSIONS IN INCHES (MM)

Description	PILC Insulation Range	Nominal PILC Size	Poly Insulation Range	Nominal Poly Size
15 kV				
CATJ-1581M0	0.69 - 1.06 (17.5 - 27.0)	#2 - 250 kcmil	0.69 - 1.20 (17.5 - 30.5)	#2 - 250 kcmil
CATJ-1582M1	0.84 - 1.30 (21.3 - 33.0)	4/0 - 350 kcmil	0.87 - 1.40(22.1 - 36.0)	4/0 - 500 kcmil
CATJ-1583M2	0.93 - 1.38 (23.6 - 35.0)	350 - 500 kcmil	1.03 - 1.58 (26.2 - 40.0)	350 - 750 kcmil
CATJ-1584M3	1.18 - 1.75 (30.0 - 44.4)	500 - 750/800 kcmil	1.28 - 2.05 (34.5 - 52.0)	750 - 1100 kcmil
28 kV				
CATJ-2881M0	0.69 - 1.06 (17.5 - 27.0)	#1 - 250 kcmil	0.69 - 1.20 (17.5 - 30.5)	#1 - 250 kcmil
CATJ-2882M1	0.84 - 1.30 (21.3 - 33.0)	4/0 - 550 kcmil	0.87 - 1.40 (22.1 - 36.0)	4/0 - 500 kcmil
CATJ-2883M2	1.07 - 1.48 (27.1 - 37.2)	350 - 500 kcmil	1.03 - 1.58 (26.2 - 40.0)	350 - 750 kcmil
CATJ-2884M3	1.18 - 1.75 (30.0 - 44.4)	500 - 750/800 kcmil	1.28 - 2.05 (34.5 - 52.0)	750 - 1000 kcmil

ADDITIONAL PRODUCT INFORMATION

- Selections are based on the typical dimensions of 100% insulated cables, manufactured in accordance with AEIC standard. Nominal insulation thickness (100%): 15 kV: 175mils, 25 kV: 260mils, 35 kV: 345mils.
- Select the appropriate catalog number. Use the insulation O.D. and jacket O.D. range as the final ordering criteria.
- Standard package: 1 kit/box.
- Related test reports: EDR-5484.

CATJ-T Cold Applied Trifurcating Transition Joint

FEATURES

- Easy to install lead seal and connector seal
- Pre-expanded silicone joint bodies
- Cold-applied oil barrier tube requires no special restricting tapes
- Range-taking oil stop shear bolt connectors supplied within the kit
- Unique PILC filling and phase sealing materials
- Robust wrap around re-jacketing solution

APPLICATIONS

- TE's Raychem CAT-J cold applied trifurcating transition joint for 3/C PILC cables to 3 1/C solid dielectric cables

BENEFITS

- ♦ The CATJ-T joints offer a reliable, robust and easy-to-install cold applied transition jointing system.
- ♦ CATJ-T cold applied transition joints are designed to cover a wide range of applications and to accommodate the variety of cable and conductor types.

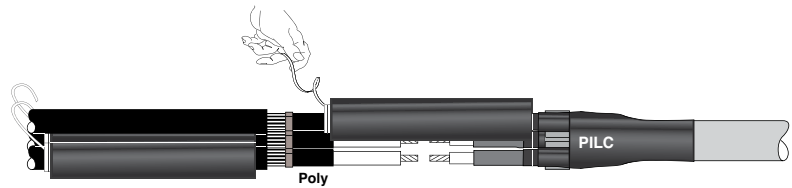

PRODUCT SELECTION INFORMATION: DIMENSIONS IN INCHES (MM)

Description	PILC Insulation Range	Nominal PILC Size	Poly Insulation Range	Nominal Poly Size	Kit Install Length
15 kV					
CATJ-T-1581M0	0.69 - 1.06 (17.5 - 27.0)	#2 - 250 kcmil	0.69 - 1.20 (17.5 - 30.5)	#2 - 250 kcmil	38
CATJ-T-1582M1	0.84 - 1.30 (21.3 - 33.0)	4/0 - 350 kcmil	0.87 - 1.40 (22.1 - 36.0)	4/0 - 500 kcmil	38
CATJ-T-1583M2	0.93 - 1.42 (23.6 - 36.0)	250 - 500 kcmil	1.03 - 1.58 (26.2 - 40.0)	250 - 750 kcmil	42
CATJ-T-1584M3	1.18 - 1.75 (30.0 - 44.4)	600 - 800 kcmil	1.28 - 2.05 (34.5 - 52.0)	750 - 1100 kcmil	42
28 kV					
CATJ-T-2883M2	1.07 - 1.48 (27.1 - 37.2)	350 - 500 kcmil	1.03 - 1.58 (26.2 - 40.0)	350 - 500 kcmil	42
CATJ-T-2884M3	1.18 - 1.75 (30.0 - 44.4)	500 - 800 kcmil	1.28 - 2.05 (34.5 - 52.0)	500 - 1000 kcmil	42

ADDITIONAL PRODUCT INFORMATION

- Selections are based on the typical dimensions of 100% insulated cables, manufactured in accordance with AEIC standard. Nominal insulation thick-ness (100%): 15 kV: 175mils, 25 kV: 260mils, 35 kV: 345mils.
- Select the appropriate catalog number. Use the insulation O.D. and jacket O.D. range as the final ordering criteria.
- Standard package: 1 kit/box.
- Related test reports: 15kV:EDR-5462, 28kV:EDR-5548, EDR-5485

Gelcap 8 Motor Connection Kits

FEATURES

- The specially formulated material provides excellent abrasion resistance, insulation value, and UV resistance. The cap is designed to fit 5-8 kV shielded and non-shielded cable.

APPLICATIONS

- TE's Raychem GelCap 8 stub connection kits insulate, seal, and protect stub splice connections up to 8 kV. The design was engineered to provide quick, secure installation and protection of the electrical connection from both physical and chemical attacks common in the harsh environment of motor connections.
- Simply place the gel filled insert between the cables and push the cover down over the connection. Secure with cable tie. No extra materials or grease are required. No trimming.

BENEFITS

- Provide quick installation, dependable performance, and easy reentry.
- Kits feature revolutionary PowerGel sealing gel which provides an excellent moisture seal over a wide temperature range (-40°C to 105°C).
- PowerGel sealing gel has excellent insulating properties and the added benefit of acting as a vibration damper.
- GelCap 8 stub connection kits provide the fastest installation.
- The PowerGel sealing gel is already in the cap.

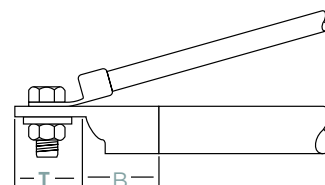

PRODUCT SELECTION INFORMATION: DIMENSIONS IN INCHES (MM)

Catalog Number	Cap Length	Feeder Cable O.D.	Nominal Size	Lead Cable O.D.	Max Length		
					Tang	Barrel	Bolt
GelCap-8-NS Non-Shielded Cable							
GELCAP-8-NS-1V	8.5 (216)	0.47-0.84 (12-21)	4-250 kcmil	0.43-0.67 (11-17)	1.33 (34)	1.00 (25)	0.75 (19)
GELCAP-8-NS-1VEX	11.5 (292)	0.47-0.84 (12-21)	4-250 kcmil	0.43-0.67 (11-17)	3.53 (90)	1.00 (25)	0.75 (19)
GELCAP-8-NS-2V	12.5 (318)	0.84-1.10 (21-28)	250-500 kcmil	0.67-0.84 (17-21)	3.92 (100)	2.25 (57)	1.0 (25)
GelCap-8-S Shielded Cable							
GELCAP-8-S-1V	8.5 (216)	0.67-1.00 (17-25)	4-2/0 AWG	0.40-0.62 (10-16)	1.33 (34)	1.00 (25)	0.75 (19)
GELCAP-8-S-1VEX	11.5 (292)	0.67-1.00 (17-25)	4-2/0 AWG	0.40-0.62 (10-16)	3.64 (92)	1.00 (25)	0.75 (19)
GELCAP-8-S-2V	12.5 (318)	1.00-1.35 (25-34)	4/0-500 kcmil	0.62-0.96 (16-24)	3.79 (96)	2.00 (51)	1.00 (25)
Ground Kit (Select Based on Shielded Cable Shield Diameter and Jacket Diameter Per Below)							
	Shield O.D. (min)	Jacket O.D. (max)					
GELCAP-8-GRD-1	.47 (12)	.70 (18)					
GELCAP-8-GRD-2	.67 (17)	1.35 (34)					

Kit contents - Each GELCAP-8-GRD kit contains the following: three each solder blocked ground braid, GelCap sealing cover, roll spring, gel sealant strip, and six each copper tape strips and one installation instruction. If grounding is required at the motor box for shielded cable, a separate grounding kit may be purchased.

PRODUCT PERFORMANCE

AC Voltage withstand: 18 kV, 1 minute

DC Voltage withstand: 35 kV, 15 minutes

Impulse Withstand (BIL): minimum performance 75 kV, 10+, 10-

ADDITIONAL PRODUCT INFORMATION

- Select appropriate catalog number based on the motor feeder cable and motor lead guidelines above. Selections are based on typical cable dimensions. Confirm selection with cable and connector dimensions.
- Packaging: Standard packaging is one kit per box. Each GelCap 8 kit contains components for a 3 phase motor connection which consists of three each of the following: elastomeric, gel filled cap; a gel filled cable insert; and cable tie. The type S kits for shielded cable also contain three each stress control pads.
- Kits do not contain connectors.
- Related tests reports: EDR-5408

MCK-5 Flame Retardant Splice to 8.7 kV

FEATURES

- TE's Raychem MCK-5 is rated to the general electrical requirements of the IEEE-48 withstand tests
- Motor connection kit provides excellent insulation sealing—and resistance to abrasion—in motor connections
- MCK is qualified to ANSI-C119.1 and rated to ICEA electrical withstand test for 1000 V.

APPLICATIONS

- For use as an in-line or stub splice between 1/C poly feeder cable and motor leads

BENEFITS

- The Type V kit is designed to splice the stub or butt configuration that is commonly used where there is insufficient room to make in-line connections.
- The Type L kit is used, where space permits, to splice in-line connections.



PRODUCT SELECTION INFORMATION: DIMENSIONS IN INCHES (MM)

Catalog Number	Motor Feeder Size AWG/kcmil	Bolt Length Max	Connector Length Max	Length Nominal
Type V (Stub)				Cap
MCK-5-1V	#8-#2	1.0	5.0 (127)	7.5 (191)
MCK-5-2V	#1-250	1.5	6.0 (152)	8.5 (216)
MCK-5-3V	300-750	1.5	7.0 (178)	9.5 (241)
Type L (In-Line)			Sleeve	
MCK-5-1L	#8-250	1.0	6.0 (152)	12.0 (305)
MCK-5-2L	300-1000	1.5	7.0 (178)	14.0 (356)
<i>MCK (5/8.7 kV)</i>				

ADDITIONAL PRODUCT INFORMATION

- Select appropriate catalog number based on the motor feeder cable. TE's Raychem MCK-5 selections are based on the typical dimensions of 100% insulated cables and the dimensions of commonly used connectors manufactured in accordance AEIC standard. Nominal insulation thickness (100%): 90 mils. For cables manufactured to other specifications, confirm selection with cable and connector dimensions.
- Shielded cable must be terminated before installing MCK-5 (use TE Connectivity HVT-8x-G or HVT-Z-8x-G/SG. G only for HVT).
- TE's Raychem MCK-5 kits are designed for single-hole connectors and include caps and sealant strips for three connections. Kits do not contain connectors.
- Standard package: MCK-5: 1 kit/box
- Related test reports: MCK-5: EDR-5010

ELB-15/28-600 Series: 600/900A T-Body 15/28 kV Connector

FEATURES

- Peroxide cured EPDM rubber ensures low tension set and high dielectric strength
- 100% factory production tested for partial discharge and AC Hipot per IEEE 386
- 600/900 Amp 15/28 kV class.
- Molded semiconducting shield provides ground shield continuity per the requirements of IEEE 592
- Meets IEEE 386-2006 specification requirements

APPLICATIONS

- TE's Raychem ELB-15/28-600 series is designed to terminate underground cables to high-voltage apparatus such as transformers and switchgear.
- Designed for use on extruded (XLPE or EPR) solid dielectric cable. The conductor range is from #1 AWG to 1250 kcmil for aluminum or copper conductors with insulation diameters from .640 to 1.965 inches.

BENEFITS

- Fully Shielded and fully submersible.
- Interchangeable with other manufacturers products that conform with this industry standard.
- Optional capacitive test point provided on elbow
- Fits 15/28 kV cables up to 1250 kcmil



The ELB-15/28-610 elbow has a capacitive test point molded into the elbow body which provides a means of sensing voltage and provides an attachment point for test point fault indicators. *900A ratings can be achieved by ordering the kit with a copper shearbolt terminal.

As an option, the elbow can also be ordered with TE's Aluminum or Copper Shear Bolt Terminals. These are range taking mechanical connectors that will accommodate a conductor range from #2 compact to 1250 kcmil stranded, Class B.

The shear bolt terminal design incorporates shear head bolts, which ensures that the correct torque is applied to each bolt and consequently the optimal contact force is generated to minimize connection resistance. Eliminating the need for crimp tooling and dies, they are therefore ideal when installation space is confined.

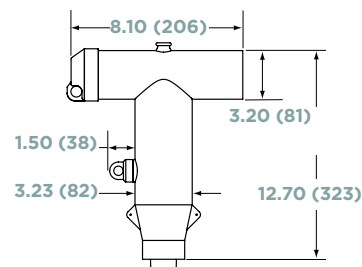

PRODUCT SELECTION INFORMATION

The part number for 15/28kV Elbow, 600 A with test point, an insulation OD of 1.755", and 750 kcmil stranded cable is ELB-35-610R750. (Or with AL Shear Bolt ELB-15/28-610K-A3) *When Copper shear bolt is specified, kit will automatically include copper insulating plug and stud, therefore offering 900A capability.

ELB-15/28-		1	2	3
Current Rating/Test Point				
600 = 600 AMP WITHOUT test point on T-Body				
610 = 600 AMP WITH test point on T-Body				
Cable Adapter Section				
Cable Insulation O.D. Range				
Code	inches (mm)			
A	.640-.760 (16.3-19.3)			
B	.720-.845 (18.3-21.5)			
C	.785-.970 (19.9-24.6)			
D	.910-1.065 (23.1-27.1)			
E	.980-1.140 (24.9-29.0)			
F	1.080-1.280 (27.4-32.5)			
G	1.220-1.420 (31.0-36.1)			
H	1.360-1.560 (34.5-39.6)			
J	1.480-1.700 (37.6-43.2)			
K	1.640-1.840 (41.7-46.7)			
L	1.780-1.965 (45.2-49.9)			
Adapters also sold separately: ELB-15/28-600-CA-X (X = Code)				

Compression Lug Section			
Conductor Size (Aluminum or Copper)			
Code	Str/Comp	Compact	Solid
1	1	1/0	1/0
2	2	2	2
10	1/0	2/0	2/0
20	2/0	3/0	3/0
30	3/0	4/0	4/0
40	4/0	250	—
250	250	300	—
300	300	350	—
350	350	400	—
400	400	450/500	—
450	450	500/550	—
500	500	600	—
550	550	650	—
600	600	700	—
650	650	750/800	—
750	700/750	900	—
800	800	900	—
900	900	1000	—
1000	1000	—	—
1100	1100	—	—
1250	1250	—	—

Aluminum Shear Bolt Conductor Size	
Code	Compression, Compact, Strand
-A1	2-350
-A2	350-750
-A3	600-1000
-A4	1000-1250

Copper Shear Bolt Conductor Size	
Code	Compression, Compact, Strand
-C1	2-4/0
-C2	2/0-500
-C3	300-750
-C4	500-1000
-C5	1000-1250

ADDITIONAL PRODUCT INFORMATION

- To include a sealing kit, add "-ESA" suffix for heat-shrinkable and "-CES" suffix for cold applied GelWrap ES closure.
- If using copper tape cable, accessory ELB-35-600-GRDx (x = 1, 2, or 3) is required and ordered separately.
- Related test reports:
EDR-5476, EDR-5482, EDR-5502, EDR-5503, EDR-5543



ELB-35-600 Series: 600/900 Amp 35 kV Class T-Body Connector

FEATURES

- Peroxide cured EPDM rubber ensures low tension set and high dielectric strength
- 100% factory production tested for partial discharge and AC Hipot per IEEE 386
- Molded semiconducting shield provides ground shield continuity per the requirements of IEEE 592
- Meets IEEE 386-2006 specification requirements

APPLICATIONS

- Designed to terminate underground cables to high-voltage apparatus such as transformers and switchgear.
- Designed for use on extruded (XLPE or EPR) solid dielectric cable. The conductor range is from #1 AWG to 1250 kcmil for aluminum or copper conductors with insulation diameters from .930" - 2.145".

BENEFITS

- Fully Shielded and fully submersible
- Interchangeable with other manufacturers products that conform with this industry standard.
- Optional capacitive test point provided on elbow.
- Fits 35 kV cables up to 1250 kcmil.
- 200 kV BIL design available.
- Exceeds insulation level requirements in IEEE 386.



ELB KIT CONTENTS

Elbow, Insulating Plug*, Cable Adapter, Stud*, Connector*, Silicone Lubricant, Installation Instruction, Jacket Seal (optional) *When Copper shear bolt is specified, kit will automatically include copper insulating plug and stud, therefore offering 900A capability.

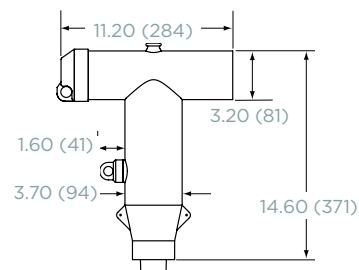

The ELB-35-610 Elbow has a capacitive test point molded into the elbow body which provides a means of sensing voltage and provides an attachment point for test point fault indicators. 900A ratings can be achieved by ordering the kit with a copper shearbolt terminal.

As an option, the elbow can also be ordered with TE's Aluminum or Copper shear bolt Terminals. These are range taking mechanical connectors that will accommodate a conductor range from #2 compact to 1250 kcmil stranded, Class B.

The shear bolt terminal design incorporates shear head bolts, which ensures that the correct torque is applied to each bolt and consequently the optimal contact force is generated to minimize connection resistance. Eliminating the need for crimp tooling and dies, they are therefore ideal when installation space is confined.

ADDITIONAL PRODUCT INFORMATION

- To include a sealing kit, add "-ESA" suffix for heat-shrinkable or "-CES" suffix for cold applied sleeve.
- If using copper tape cable, accessory ELB-35-600-GRDx (x = 1, 2, or 3) is required and ordered separately.
- Related test reports: EDR-5476, EDR-5502, EDR-5503, EDR-5543, EDR-5477, EDR-5642
- For a 35 kV Elbow, 600 A with test point, an insulation O.D. of 1.755 inches, and 750 kcmil stranded cable is ELB-35-610R750.

ELB-35-

1

2

3

4

Current Rating/Test Point

600 = 600 AMP WITHOUT test point on T-Body
610 = 600 AMP WITH test point on T-Body

Note: 600 AMP kit is provided with aluminum components.

Cable Adapter Selection Cable Insulation O.D. Range

Code	inches (mm)
E	.930-1.040 (23.6-26.4)
F	.980-1.115 (24.9-28.3)
G	1.040-1.175 (26.4-29.8)
H	1.095-1.240 (27.8-31.5)
J	1.160-1.305 (29.5-33.1)
K	1.220-1.375 (31.0-34.9)
L	1.285-1.395 (32.6-35.4)
M	1.355-1.520 (34.4-39.0)
N	1.485-1.595 (37.7-40.5)
P	1.530-1.640 (38.9-41.7)
Q	1.575-1.685 (40.0-42.8)
R	1.665-1.785 (42.3-45.3)
S	1.775-1.875 (45.1-47.6)
T	1.845-1.965 (46.9-50.0)
U	1.935-2.055 (49.1-52.2)
V	2.025-2.145 (51.4-54.5)

Adapters also sold separately:
ELB-35-600-CA-X (X = Code)

Compression Lug Selection

Conductor Size (Aluminum or Copper)

Code	Str/Comp	Compact	Solid
1	—	1/0	1/0
10	1/0	2/0	2/0
20	2/0	3/0	3/0
30	3/0	4/0	4/0
40	4/0	250	—
250	250	300	—
300	300	350	—
350	350	400	—
400	400	450/500	—
450	450	500/550	—
500	500	600	—
550	550	650	—
600	600	700	—
650	650	750/800	—
750	700/750	900	—
800	800	900	—
900	900	1000	—
1000	1000	—	—
1100	1100	—	—
1250	1250	—	—

Compression lugs sold separately: ELB-600-CONN-AL-X (X=Code)

Aluminum Shear Bolt | Conductor Size

Code	Compression, Compact, Strand
-A1	2-350
-A2	350-750
-A3	750-1000
-A4	1000-1250

Copper Shear Bolt | Conductor Size

Code	Compression, Compact, Strand
-C1	2-4/0
-C2	4/0-500
-C3	500-750
-C4	750-1000
-C5	1000-1250

Shearbolts also sold separately: ELB-600-CONN-X (X = Code)

Blank = 150 kV BIL

200 = 200 kV BIL

Deadbreak Standoff Plug

FEATURES

- 15/28 kV or 35 kV, 600A ratings
- Designed to be installed in the parking stand of apparatus
- Fully-shielded, fully submersible connection
- Stainless steel eyebolt with a stainless steel pressure foot
- Body bolted to stainless steel base bracket
- Compatible with 900A, all copper circuits
- Conforms to ANSI/IEEE standard 386

APPLICATIONS

- TE's Raychem Deadbreak standoff plug is meant for use in a parking stand of an apparatus or junction, where it provides insulated protection for energized 15/28-35 kV deadbreak interfaces.
- They are frequently used temporarily or permanently within padmount cabinets, underground vaults, switchgear, transformers, and a variety of other apparatus. Typical applications include isolating and sectionalizing energized cable, system maintenance, circuit reconfiguration, and future expansion.

BENEFITS

- ♦ Interchangeable with other manufacturers' products that also comply with IEEE-386 standard.



RATINGS

Voltage Class	15/28 kV	35 kV
Max. Rating Phase-to-Ground	16.2 kV	21.1 kV
Max. Rating Phase-to-Phase	28 kV	36.6 kV
AC 1 minute withstand	45 kV	50 kV
DC 15 minute withstand	88 kV	103 kV
BIL and full wave crest	140 kV	150 kV
Minimum Corona Level	21.5 kV (3pC)	26 kV (3pC)
Continuous	600A rms	600A rms
24 Hour Overload	1,000A rms	1,000A rms
Momentary:		
25,000 A symmetrical 10 cycles		
10,000 A symmetrical 3.00 sec		

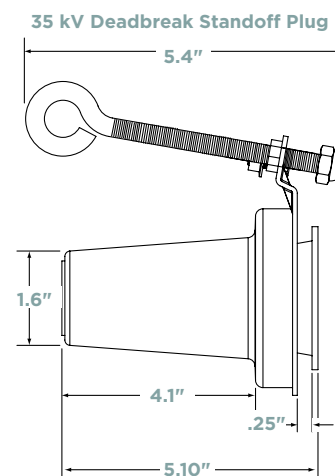
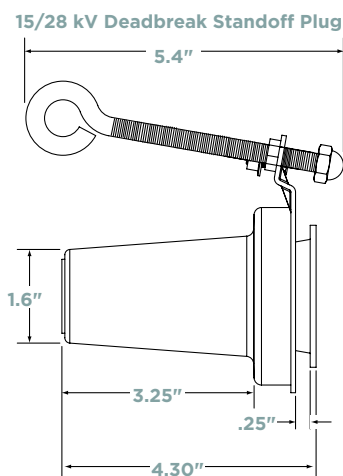

PRODUCT SELECTION INFORMATION

Catalog Number	Voltage Class	Current Rating	Description
ELB-15/28-600-SP	15/28 kV	600	Aluminum Deadbreak Standoff Plug
ELB-35-600-SP	35 kV	600	Aluminum Deadbreak Standoff Plug

Related test reports: EDR-5510

Deadbreak Insulating Cap

FEATURES

- 15/28 kV, 600A ratings available
- Includes a semiconducting EPDM insert for stress relief
- High quality peroxide cured EPDM insulation
- Provides insulated, fully shielded, submersible connection
- Maintains ground potential on the cap's surface when the drain wire is connected to a common ground
- Compatible with 900A, all-copper circuits
- Conforms to ANSI/IEEE Standard 386

APPLICATIONS

- TE's Raychem 600A deadbreak insulating cap is available in 15/28 kV class. The insulating cap is meant to provide insulated protection for energized 15-28 kV deadbreak interfaces.
- Typical applications include system maintenance, circuit reconfiguration, and future expansion.

BENEFITS

- ♦ Interchangeable with other manufacturers' products that also comply with IEEE-386 standard.

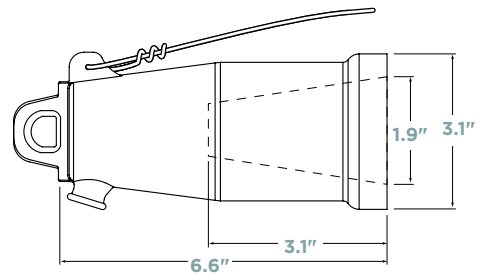

RATINGS

Voltage Class	15/28 kV
Max. Rating Phase-to-Ground	16.2 kV
Max. Rating Phase-to-Phase	28 kV
AC 1 minute withstand	45 kV
DC 15 minute withstand	88 kV
BIL and full wave crest	140 kV
Minimum Corona Level	21.5 kV (3pC)

PRODUCT SELECTION INFORMATION

Catalog Number	Voltage Class	Current Rating	Description
ELB-15/28-600-IC	15/28 kV	600	Aluminum Deadbreak Insulating Cap

Deadbreak Connecting Plug

FEATURES

- 15/28 kV or 35 kV, 600 or 900A ratings available
- Fully submersible
- Industry standard 5/8 inch - 11 threaded stud used for electrical connection
- Available in either Aluminum or Copper
- Conforms to ANSI/IEEE Standard 386 E

APPLICATIONS

- TE's Raychem Deadbreak Connecting Plug is available in both 15/28 kV and 35 kV class versions. The connecting plug is meant to connect two or more 600/900A deadbreak elbows.
- Typical applications are as a separable cable splice, circuit reconfiguration, or as an expandable, submersible junction.

BENEFITS

- ♦ 900A ratings are achieved by ordering the copper version, but require copper cable and other copper constructed components.
- ♦ Interchangeable with other manufacturers' products that also comply with this standard.



RATINGS

Voltage Class	15/28 kV	35 kV
Max. Rating Phase-to-Ground	16.2 kV	21.1 kV
Max. Rating Phase-to-Phase	28 kV	36.6 kV
AC 1 minute withstand	45 kV	50 kV
DC 15 minute withstand	88 kV	103 kV
BIL and full wave crest	140 kV	150 kV
Minimum Corona Level	21.5 kV (3pC)	26 kV (3pC)
Continuous	600/900A rms	600/900 A rms
24 Hour Overload	1,000A rms	1,000A rms
Momentary:		
600A	25,000 A symmetrical 10 cycles	
600A	10,000 A symmetrical 3.00 sec	
900A	40,000 A symmetrical 10 cycles	
900A	10,000 A symmetrical 3.00 sec	

100% PRODUCTION TEST

Minimum Corona level	21.5 kV (3pC)	26 kV (3pC)
AC 1 minute withstand	45 kV	50 kV

15/28 kV Deadbreak Connecting Plug

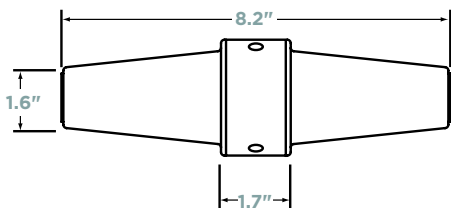

35 kV Deadbreak Connecting Plug

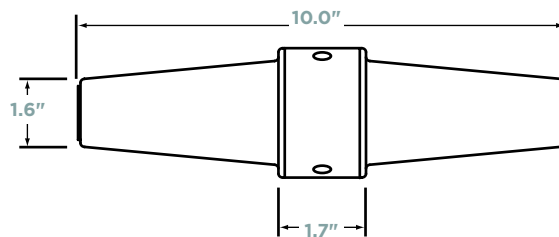

PRODUCT SELECTION INFORMATION

Catalog Number	Voltage Class	Current Rating	Description
ELB-15/28-600-CP-AL	15/28 kV	600	Aluminum Deadbreak Connecting Plug
ELB-35-600-CP-AL	35 kV	600	Aluminum Deadbreak Connecting Plug
ELB-15/28-900-CP-CU	15/28 kV	600/900	Copper Deadbreak Connecting Plug
ELB-35-900-CP-CU	35 kV	600/900	Copper Deadbreak Connecting Plug

Related test reports: EDR-5511

Deadbreak Junctions

FEATURES

- Available in 2, 3, 4 point configurations
- Deadfront, 15/28 kV or 35 kV, 600 or 900A Ratings
- EPDM molded rubber construction
- Optional corrosion resistant stainless steel (adjustable or stationary) mounting brackets for direct wall mounting
- Maintenance free, fully shielded, submersible
- Conforms to ANSI/IEEE Standard 386
- Heavy duty U-straps provide secure mounting for junctions

APPLICATIONS

- TE's Raychem 600A/900A deadbreak junction is available in both 15/28 kV and 35 kV Class versions. Deadbreak junctions are used with 600/900A elbows and accessories for connecting, establishing loops, tapping, and facilitating apparatus change out.
- They are commonly used in pad-mounted apparatus, sectionalizing cabinets, and underground vaults, where there is a critical use of space, flexibility, and operability.
- Applications include padmount, indoor/outdoor vault, subsurface

BENEFITS

- ♦ The junction provides two, three, or four deadbreak interfaces bused together and encapsulated in a molded, peroxide-cured EPDM insulated rubber body, with an EPDM peroxide-cured semi-conductive outer shield.
- ♦ Optional stationary or adjustable mounting brackets are available, assembled with the junctions themselves.
- ♦ 900A ratings are achieved by ordering the copper version, but require copper cable and other copper constructed components.
- ♦ Interchangeable with other manufacturers' products that also comply with this standard.



RATINGS

Voltage Class	15/28 kV	35 kV
Max. Rating Phase-to-Ground	16.2 kV	21.1 kV
Max. Rating Phase-to-Phase	28 kV	36.6 kV
AC 1 minute withstand	45 kV	50 kV
DC 15 minute withstand	88 kV	103 kV
BIL and full wave crest	140 kV	150 kV
Minimum Corona Level	21.5 kV (3pC)	26 kV (3pC)
Continuous	600/900A rms	600/900 A rms
24 Hour Overload	1,000A rms	1,000A rms
Momentary:		
600A	25,000 A symmetrical 10 cycles	
600A	10,000 A symmetrical 3.00 sec	
900A	40,000 A symmetrical 10 cycles	
900A	10,000 A symmetrical 3.00 sec	

PRODUCT SELECTION INFORMATION

Catalog Number	Current Rating	Size	Material
Junction with U-Strap 15/28 kV			
ELB-15/28-600-J2-AL	600A	J2	Aluminum
ELB-15/28-600-J3-AL	600A	J3	Aluminum
ELB-15/28-600-J4-AL	600A	J4	Aluminum
ELB-15/28-900-J2-CU	600/900A	J2	Copper
ELB-15/28-900-J3-CU	600/900A	J3	Copper
ELB-15/28-900-J4-CU	600/900A	J4	Copper
Junction with U-Strap 35 kV			
ELB-35-600-J2-AL	600A	J2	Aluminum
ELB-35-600-J3-AL	600A	J3	Aluminum
ELB-35-600-J4-AL	600A	J4	Aluminum
ELB-35-900-J2-CU	600/900A	J2	Copper
ELB-35-900-J3-CU	600/900A	J3	Copper
ELB-35-900-J4-CU	600/900A	J4	Copper
Junction with Stationary Bracket Included 15/28 kV			
ELB-15/28-600-J2-AL-STD	600A	J2	Aluminum
ELB-15/28-600-J3-AL-STD	600A	J3	Aluminum
ELB-15/28-600-J4-AL-STD	600A	J4	Aluminum
ELB-15/28-900-J2-CU-STD	600/900A	J2	Copper
ELB-15/28-900-J3-CU-STD	600/900A	J3	Copper
ELB-15/28-900-J4-CU-STD	600/900A	J4	Copper
Junction with Stationary Bracket Included 35 kV			
ELB-35-600-J2-AL-STD	600A	J2	Aluminum
ELB-35-600-J3-AL-STD	600A	J3	Aluminum
ELB-35-600-J4-AL-STD	600A	J4	Aluminum
ELB-35-900-J2-CU-STD	600/900A	J2	Copper
ELB-35-900-J3-CU-STD	600/900A	J3	Copper
ELB-35-900-J4-CU-STD	600/900A	J4	Copper
Junction with Adjustable Bracket Included 15/28 kV			
ELB-15/28-600-J2-AL-ADJ	600A	J2	Aluminum
ELB-15/28-600-J3-AL-ADJ	600A	J3	Aluminum
ELB-15/28-600-J4-AL-ADJ	600A	J4	Aluminum
ELB-15/28-900-J2-CU-ADJ	600/900A	J2	Copper
ELB-15/28-900-J3-CU-ADJ	600/900A	J3	Copper
ELB-15/28-900-J4-CU-ADJ	600/900A	J4	Copper
Junction with Adjustable Bracket Included 35 kV			
ELB-35-600-J2-AL-ADJ	600A	J2	Aluminum
ELB-35-600-J3-AL-ADJ	600A	J3	Aluminum
ELB-35-600-J4-AL-ADJ	600A	J4	Aluminum
ELB-35-900-J2-CU-ADJ	600/900A	J2	Copper
ELB-35-900-J3-CU-ADJ	600/900A	J3	Copper
ELB-35-900-J4-CU-ADJ	600/900A	J4	Copper

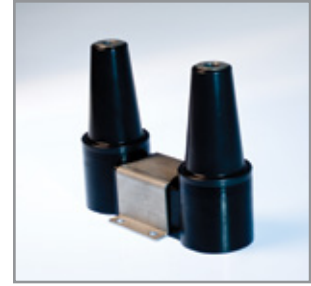

Related test reports: EDR-5508

ELB-15/28-600 Elbow Modular Splice Systems

FEATURES

- Peroxide cured EPDM rubber ensures low tension set and high dielectric strength
- 100% factory production tested for partial discharge and AC Hipot per IEEE 386
- Fits 15-35 kV cables up to 1250 kcmil
- Both compression lugs and range taking shear bolt connectors are available, along with the required cable adapter (sold separately)
- Designed for use on extruded (XLPE or EPR) solid dielectric cable

APPLICATIONS

- TE's Raychem ELB-15/28-600 offers separable solutions to fit a variety of needs which include: splicing, connecting to apparatus, dead-ending, and the ability to easily reconfigure circuits.
- At 15-35 kV 600 Amp, the following options are available: 2-way, 3-way, 4-way, or dead-end connections.

BENEFITS

- ♦ These kits use TE standard T-bodies, connecting plugs, insulating plugs, and conductive caps.
- ♦ They are fully shielded and fully submersible and meet the requirements of IEEE Standard 386.
- ♦ Interchangeable with other manufacturers' products that conform with this industry standard.

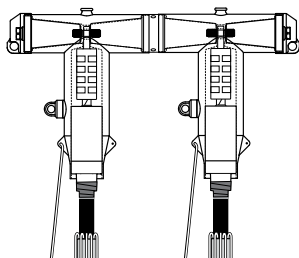

Kit Description	Assembly
ELB-15/28-600-T1WAY	
ELB-15/28-610-T1WAY	
ELB-35-600-T1WAY	
ELB-35-610-T1WAY	
ELB-15/28-600-T2WAY	
ELB-15/28-610-T2WAY	
ELB-35-600-T2WAY	
ELB-35-610-T2WAY	
ELB-15/28-600-T3WAY	
ELB-15/28-610-T3WAY	
ELB-35-600-T3WAY	
ELB-35-610-T3WAY	
ELB-15/28-600-T4WAY	
ELB-15/28-610-T4WAY	
ELB-35-600-T4WAY	
ELB-35-610-T4WAY	

PRODUCT SELECTION INFORMATION: DIMENSIONS IN INCHES (MM)

Assembly	Approximate Width of Splicing System	
	15/28 kV	35 kV
Deadend (One Way)	10.1 (256)	12.1 (307)
Two Way	19.0 (483)	23.0 (584)
Three Way	27.9 (709)	33.9 (861)
Four Way	36.8 (935)	44.8 (1138)

ADDITIONAL PRODUCT INFORMATION

- Due to the variety of configurations possible, cable adapters and connectors are not included as part of this kit. Each one sold separately. Contact your local TE sales representative for assistance.
- A spanner wrench (ELB-600-SPANNER, sold separately) may be required for proper installation.
- If using copper tape cable, accessory ELB-35-600-GRDx (x = 1, 2 or 3) is required and ordered separately.
- Sealing kits are available separately: the ESA for heatshrink, GES for cold-applied Gelwrap ES closure, and CES for cold-applied rip-cord style.
- Related test reports: EDR-5482, EDR-5476, EDR-5502, EDR-5503, EDR-5511, EDR-5477, EDR-5543.

ELB-35-600 Arrester

FEATURES

- The 600A interface bolts directly to a bushing, saving space and eliminating the need for adaptors.
- Tested in accordance with the dead front arrester failure mode test, which has proven TE's Raychem elbow arrester to have safe and predictable failure characteristics.
- Large diameter MOV elements provide high energy handling capability.
- Fully submersible and meet the performance requirements of IEEE C62.11 and IEEE standard 386

APPLICATIONS

- TE's Raychem ELB-35-600 Arrester is designed to protect underground cables and high-voltage apparatus from voltage surges due to lightning and switching transients.

BENEFITS

- ♦ Eliminates the need for bushing extenders, reducing tap plugs, and 200A load break interface arresters and installs in the same manner as a standard 35 kV 600 A elbow.
- ♦ All MOV elements and end fittings are in a single epoxy fiber module. There are no glued interfaces. The design is void and gap free ensuring peak performance under the harshest conditions.



PERFORMANCE CHARACTERISTICS

High Current Short Duration	65kA, 4 x 10µsec
Low Current Long Duration	75A, 2000µsec
Duty Cycle	5kA, 8 x 20µsec

Following each of the preceding tests the arrester demonstrates thermal recovery at MCOV.

100% Production Test
 Partial Discharge 26 kV (10pc)
 AC 1 minute withstand 50 kV (housing only)
 Reference Voltage Test

ELB-35-600-ARSTR Kit Contents:

- Elbow Arrester
- Insulating Plug (AI)
- Stud (AI)
- 36" tinned Cu Ground Lead
- Silicone Lubricant
- Installation Instructions

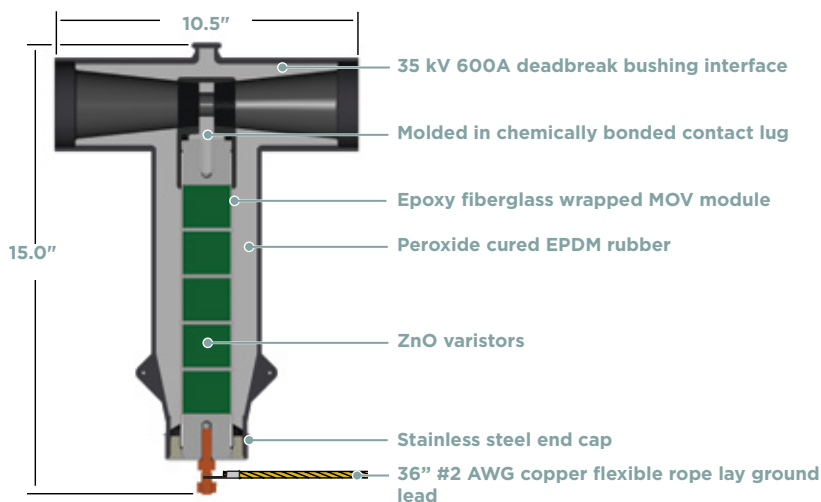

PRODUCT SELECTION INFORMATION

Catalog Number	Duty Cycle Rating (kV/rms)	MCOV (kV/rms)	Max Discharge Voltage (kV crest) 8 x 20 microsecond current wave			
			1.5 kA	5 kA	10 kA	20 kA
ELB-35-600 ARSTR-27	27	22	65.6	72.3	78.2	85.7
ELB-35-600 ARSTR-30	30	24.4	72.6	79.9	86.5	94.8
ELB-35-600 ARSTR-33	33	26.8	80.1	88.2	95.4	104.5
ELB-35-600-ARSTR-36	36	29.0	87.1	95.9	103.8	113.8

Related Test Report: EDR-5506



CES Cold Applied Elbow Seal

FEATURES

- Highly elastic EPDM formulation enables wide cable application ranges. Just three products are able to cover the most common range of cable, 15 kV #2-35 kV 1250 kcmil
- An ergonomically designed spiral holdout provides a smooth installation with low release forces
- No open flame or heat source is required for installation
- Meets IEEE 404 jacket sealing requirements
- Thick walled tube resists puncture and damage
- Resistant to fungus, acids, and alkalis

APPLICATIONS

- TE's Raychem CES is used for sealing power cables where elbows or other cable accessories are installed.
- The CES is applied in 15-35 kV, 600A applications. It protects underground cable from moisture and airborne contaminants, and is suitable for both direct burial and submersible applications.

BENEFITS

- The kit consists of a factory-expanded tubular EPDM rubber sleeve on a spiral holdout, along with strips of mastic which are used to help create the seal.
- Designed for easy field installation. After applying the mastic and cable accessory, the spiral holdout is simply pulled clear.
- The jacket will compress and form an environmental seal in combination with the mastic

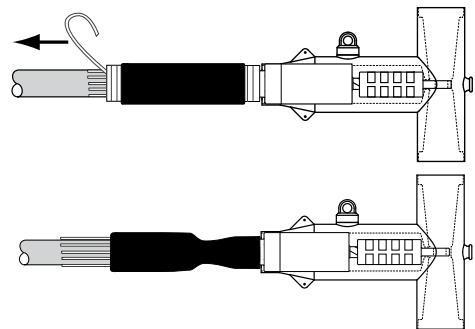

PRODUCT SELECTION INFORMATION: DIMENSIONS IN INCHES (MM)

Catalog Number	Typical Tube Length		Expanded Tube Diameter	Inner Diameter of Holdout
	Expanded	Relaxed		
ELB-600-CES-1	5.00 (127)	6.00 (150)	2.24 (57)	1.97 (50)
ELB-600-CES-2	6.75 (171)	8.00 (200)	2.95 (75)	2.68 (68)
ELB-600-CES-3	7.50 (190)	9.00 (225)	4.13 (105)	3.85 (98)

Catalog Number	Cable Size			Min Seal Diameter	Max Installed Diameter
	15 kV Class	25 kV Class	35 kV Class		
ELB-600-CES-1	2-4/0 AWG (35-100 mm ²)	2-2/0 AWG (35-50 mm ²)	1/0 AWG (60 mm ²)	0.95 (24)	1.50 (38)
ELB-600-CES-2	2/0-1000 kcmil (70-500 mm ²)	1/0 AWG-750 kcmil (60-380 mm ²)	1/0 AWG-500 kcmil (60-250 mm ²)	1.28 (33)	2.67 (68)
ELB-600-CES-3	750-1500 kcmil (380-725 mm ²)	600-1250 kcmil (325-625 mm ²)	350-1250 kcmil (180-625 mm ²)	1.60 (41)	3.50 (89)

ADDITIONAL PRODUCT INFORMATION

- Selections are based on the typical dimensions of 100% insulated cables, manufactured in accordance with AEIC standard. Nominal insulation thickness (100%): 15 kV: 175 mils, 25 kV: 260 mils, 35 kV: 345 mils.
- Select the appropriate catalog number. Use the actual insulation OD, and jacket OD range as the final ordering criteria.
- Kits used on metallic tape-shielded cables may require external grounding component. HVS-GC + HV-Braid.
- For other applications or if you have any questions, contact your TE representative.
- If ordered separate from Elbow kits, standard package: 3 kits per box.
- Related test reports: EDR-5528

ESA Heat Shrinkable Elbow Sealing Adapters

FEATURES

- 1/2 jacketed URD and shielded power cable.
- Qualified to ANSI C119.1
- RUS accepted for termination/elbow sealing

APPLICATIONS

- TE's Raychem ESA adapters are for use on jacketed concentric neutral, drain-wire-shielded, or copper-tape-shielded power cable

BENEFITS

- ♦ ESA elbow sealing adapters shrink down tightly to form an environmental re-jacketing seal.
- ♦ Use this heat shrinkable kit to seal the jacket of a power cable used with a premolded elbow.



PRODUCT SELECTION INFORMATION: DIMENSIONS IN INCHES (MM)

Catalog Number	Conductor Size (AWG/kcmil)				Diameter (min-max)
	5 kV	15 kV	25 kV	35 kV	
ESA-1	#2-500	#2-250	#1-3/0		.65-1.50 (17-38)
ESA-2	600-1000	350-1000	4/0-1000	1/0-1000	.30-2.50 (33-63)

ADDITIONAL PRODUCT INFORMATION

- Select the appropriate catalog number based on the cable conductor size and voltage class. Selections are based on the typical dimensions of 100% or 133% insulated cables manufactured in accordance with AEIC standard. For cables manufactured to other specifications, selection should be confirmed with cable dimensions.
- Kits used on metallic-tape-shielded cables may require an external grounding kit.
- Standard package: 3 kits/box.
- Related test report: EDR-5145.

Gelwrap ES Wrap-Around Cold-Applied Elbow Sealing Adapter

FEATURES

- The sleeve is factory coated with PowerGel sealant to provide a positive moisture seal. PowerGel sealant strips are included in the kit to ensure proper sealing of any neutrals or grounds exiting the sleeve.
- For 1/C jacketed cables.

APPLICATIONS

- This kit is used to seal the jacket of a power cable used with a premolded elbow.

BENEFITS

- ♦ Easily installed due to the wrap-around design. Simply install the elbow as you normally would then use the components of TE's Raychem GelWrap ES elbow sealing closure kit to provide an environmental seal.
- ♦ Pre-positioning of the sleeve is not required so retrofit installations are easily accomplished.
- ♦ One kit provides a very wide use range to minimize inventory requirements

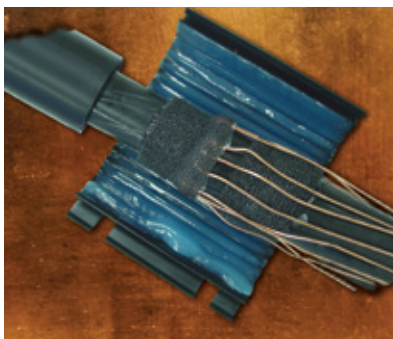

PRODUCT SELECTION INFORMATION: DIMENSIONS IN INCHES (MM)

Catalog Number	Outside Diameter		Voltage Class	Insulated Conductor Size	
	Insulation Shield (min)	Cable Jacket or Covered Arm of Elbow (max)		100%	133%
GelWrap-ES-65/25-150(B6)	1.00 (25)	2.40 (61)	5	500-1000	500-1000

ADDITIONAL PRODUCT INFORMATION

- Select the appropriate catalog number based on the cable conductor size and voltage class. Selections are based on the typical dimensions of 100% or 133% insulated cables manufactured in accordance with AEIC standard. For cables manufactured to other specifications, selection should be confirmed with cable dimensions.
- Kits used on metallic-tape-shielded cables may require an external grounding kit.
- Standard package: 3 kits/box.
- Related test report: EDR-5145.

RVS-SK Rayvolve “Roll-On” Elbow Sealing Adapters

FEATURES

- The easy, “roll-on” way to seal JCN cable jackets when they are terminated to premolded elbows.
- Qualified to ANSI C119.1
- For concentric Neutral jackets for 1/C jacketed URD cables.

APPLICATIONS

- TE’s Raychem RVS-SK are used on standard poly- or elastomeric-insulated cables
- Use to seal JCN cable jackets when terminated to pre-molded elbows

BENEFITS

- ♦ Provide an environmental seal that is maintained throughout exposure to conditions typical of elbow installations: temperature extremes (-36°F to 162°F/-20°C to 90°C), temperature cycling (41°F to 162°F/23°C to 90°C), and twisting and flexing motions as seen during switching.



PRODUCT SELECTION INFORMATION: DIMENSIONS IN INCHES (MM)

Catalog Number	Outside Diameter		Voltage Class (kV)	Insulated Conductor Size (AWG/kcmil)	
	Insulation Shield (min)	Jacket O.D. (max)		100%	133%
RVS-13-SK	0.55 (14)	1.25 (32)	5 15 25	#2-250 #2-3/0 #1	#2-250 #2-1/0
RVS-14-SK	0.70 (18)	1.60 (41)	5 15 25 35	3/0-600 #2-400 #1-250 1/0-2/0	3/0-600 #2-350 #1-3/0
RVS-15-SK*	1.15 (29)	2.00 (51)	5 15 25 35	600-1000 350-750 4/0-600 1/0-400	600-1000 250-750 1/0-500 1/0-250

ADDITIONAL PRODUCT INFORMATION

- Select the appropriate catalog number. Selections are based on typical dimensions of low voltage insulated cable. Confirm selection with dimensions to assure proper sizing.
- Kits do not contain connectors. The RVS-SK selection information covers all conductor types from solid to stranded.
- Kits contain all materials necessary to seal from the cable jacket to either the cable semi-con or 200-A elbow.
- * For warm weather installations (above 32°F), use range may be extended to a 2.25-inch-maximum jacket diameter. This covers 133%-insulated 1000-kcmil 15 kV and 25 kV cable, and 133%-insulated 750-kcmil 35 kV cable.
- Kits used on metallic-tape-shielded cables may require an external grounding kits.
- Each kit contains one Rayvolve RVS-SK sleeve and sealant strips.
- Standard package: 6 kits/box
- Related test report: EDR-5196

JGK-MS Jacketed Cable Grounding Kits

FEATURES

- Heat shrinkable JGK-MS kits provide complete environmental sealing with a wraparound, adhesive-lined re-jacketing sleeve.
- Each kit contains a constant-force ground clamp, a solder-blocked ground braid for external grounding, and a sealant to encapsulate and seal the ground connector.
- Wraparound re-jacketing sleeve has been water-seal tested to the applicable sections of ANSI C 119.1.
- TE's Raychem JGK-MS-HC kits have high fault current capability.

APPLICATIONS

- Addresses the RUS recommendation to externally ground the jacketed cable neutrals at least four times per mile to limit shield standing voltage, to avoid accidental shock, and to provide multiple parallel return paths for line-to-ground faults.

BENEFITS

- ♦ Kits are RUS accepted and have been tested to meet the 10 kA/10 cycles or 15 kA/15 cycle fault current test requirements.



PRODUCT SELECTION INFORMATION

Catalog Number	Nominal Use Range (AWG/kcmil)			Rated Fault Current
	15 kV	25 kV	35 kV	
JGK-MS-1	#4-4/0	#1-1/0		10 kA, 10 cycles
JGK-MS-2	250-1000	1/0-750	1/0-500	15 kA, 15 cycles
JGK-MS-3	1000-2000	750-1750	500-1500	15 kA, 15 cycles
JGK-MS-HC-2	250-1000	1/0-750	1/0-500	30 kA, 10 cycles
JGK-MS-HC-3	1000-2000	750-1750	500-1500	30 kA, 10 cycles

ADDITIONAL PRODUCT INFORMATION

- Standard package: 3 kits/box
- Related test report: EDR-5242

GelWrap MS-GRD

FEATURES

- Cold Applied GelWrap MS-GRD kits provide complete environmental sealing with a Gel-Filled, wraparound re-jacketing sleeve.
- Each kit contains a constant-force ground clamp, a solder-blocked ground braid for external grounding, a gel sealant strip and tie wraps.

APPLICATIONS

- TE's Raychem Gelwrap MS-GRD kit addresses the WindFarm construction recommendation to externally ground jacketed concentric neutral power cable at least four times per mile to limit/minimize shield standing voltage, to avoid accidental shock, and to provide a return path for line-to-ground faults.

BENEFITS

- ♦ Kits are tested to meet the 10 kA/10 cycles or 15 kA/15 cycle fault current test requirements.
- ♦ Wraparound re-jacketing sleeve has been water-seal tested to the applicable sections of ANSI C 119.1.

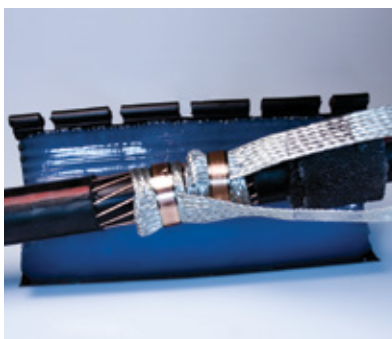

PRODUCT SELECTION INFORMATION: DIMENSIONS IN INCHES (MM)

Catalog Number	Outside Diameter		Voltage Class	Insulated Conductor Size	
	Insulation Shield (min)	Jacket O.D. (max)		100%	133%
GelWrap-MS-GRD-1	1.00 (25)	2.60 (61)	5	500-1000	500-1000
GelWrap-MS-GRD-2	1.00 (25)	2.60 (61)	5	500-1000	500-1000
GelWrap-MS-GRD-3	1.00 (25)	2.60 (61)	5	500-1000	500-1000

Catalog Number	Shield O.D. (min)	Jacket O.D. (max)	Nominal Use Range (AWG/kcmil)		
			15 kV	25 kV	35 kV
GelWrap-MS-GRD-CT-2	1.00 (25)	1.80 (46)	250-750	2/0-500	1/0-250

Catalog Number	Nominal Use Range (AWG/kcmil)			Rated Fault Current
	15 kV	25 kV	35 kV	
GelWrap-MS-GRD-1	#4-2/0	#1	n/a	10 kA, 10 cycles
GelWrap-MS-GRD-2	2/0-750	#1-500	1/0-350	15 kA, 15 cycles
GelWrap-MS-GRD-3	1000-2000	750-1750	300-1500	15 kA, 15 cycles

ADDITIONAL PRODUCT INFORMATION

- Select the appropriate catalog number based on the cable conductor size and voltage class. Selections are based on the typical dimensions of 100%- or 133%-insulated cables manufactured in accordance with the data contained in AEIC CS5. For cables manufactured to other specifications, selection should be confirmed with cable dimensions.
- Kits used on metallic-tape-shielded cables may require external grounding components. See items HVS-GC and HV-Braid.
- Standard package: 3 kits/box
- Test report: EDR-5375

HVE-1590 for Installation of Elbow (15 kV)

FEATURES

- Pressure rated to 15 psi at 90°C.
- Rated to the applicable requirements of ANSI-386.

APPLICATIONS

- TE's Raychem HVE-1590 converts PILC cable to allow installation of dead-break elbows.
- For use on 1/C PILC/VCLC cable.

BENEFITS

- Provide a highly effective and easily installed oil stop system, using standard heat shrinkable components. The system provides an oil- and pressure-resistant seal.
- Oil barrier tubing locks the oil in the PILC cables, converting each conductor into the polymeric equivalent.

HVE-1590

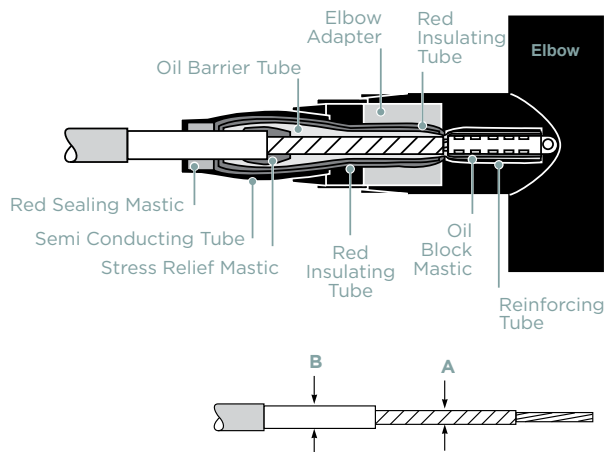

PRODUCT SELECTION INFORMATION: DIMENSIONS IN INCHES (MM)

Catalog Number	1/C 15 kV* PILC Conductor Size (Nominal)	Insulation O.D.		Lead Sheath O.D. (Max.) B	Adapter Type Elastimold
		(Min.) A	(Max.) B		
HVE-1591	#2 AWG-2/0	0.65 (16)	0.75 (19)	0.95 (24)	ELB-15/28-600-CA-F
HVE-1592	3/0-250 kcmil	0.75 (19)	0.95 (24)	1.10 (28)	ELB-15/28-600-CA-G
HVE-1593	300-500 kcmil	0.95 (24)	1.22 (31)	1.35 (34)	ELB-15/28-600-CA-H
HVE-1594	600-750** kcmil	1.22 (31)	1.35 (34)	1.50 (38)	ELB-15/28-600-CA-L

ADDITIONAL PRODUCT INFORMATION

- Select the appropriate catalog number. All selections are based on the typical dimensions of 100% insulated cables manufactured in accordance with AEIC standard. Nominal insulation thickness (100%): 15 kV: 165 mils (PILC/VCLC).
- For cables manufactured to other specifications, confirm selection with cable dimensions.
- Standard package: One kit/box
- Related test reports: 15 kV: EDR-5269.

200A Loadbreak Elbows (15kV, 25kV)

FEATURES

- Peroxide cured EPDM rubber ensures low tension set and high dielectric strength
- 100% factory production tested for partial discharge and AC Hipot per IEEE 386
- Optional capacitive test point
- Molded semiconducting shield provides ground shield continuity in accordance with IEEE 592
- Conforms to IEEE Standard 386

APPLICATIONS

- TE's Raychem loadbreak elbow connectors are designed to terminate underground cables to high-voltage apparatus such as transformers and switchgear that are equipped with bushings.
- Designed for use on extruded (XLPE or EPR) solid dielectric cable with conductor range from #1 AWG to 250 kcmil aluminum or copper conductors (insulation diameters from .575 to 1.304 inches).

BENEFITS

- ♦ Loadbreak elbows are designed for use with standard hotstick tools, which allows a loadmake/break operation with a physical disconnect.
- ♦ The 200A loadbreak elbow kit includes a copper top compression connector, which connects the cable with the loadbreak probe. Connector is easy to crimp, and suitable for aluminum and copper conductors, and forms a reliable connection.
- ♦ The elbow can be ordered with an integral jacket seal (part number suffix -ES), which is an environmental seal molded to the elbow that prevents moisture ingress.



ELB-15-210

ELB-15 **1** **2** **3** **4**

1 Current Rating | Test Point Code

200 = 200 AMP WITHOUT test point
210 = 210 AMP WITH test point

2 Cable Insulator O.D. Range

Code	Inches	mm
A	.575 - .740	14.6 - 18.8
B	.640 - .905	16.2 - 23.0
C	.830 - 1.060	21.1 - 26.9
D	.930 - 1.220	23.6 - 31.0

3 Compression Lugs | Conductor Size (Aluminum or Copper)

Code	Str/Comp	Compact	Solid
3	3	2	2
2	2	1	1
1	1	1/0	1/0
10	1/0	2/0	2/0
20	2/0	3/0	3/0
30	3/0	4/0	4/0
40	4/0	250	250

4 Jacket Sealing

Code	Type
Blank	No Jacket Seal
ES	Integral Jacket Seal

ELB-25-210

ELB-25 **1** **2** **3** **4**

1 Current Rating | Test Point Code

200 = 200 AMP WITHOUT test point
210 = 210 AMP WITH test point

2 Cable Insulator O.D. Range

Code	Inches	mm
B	.72 - .88	18.3 - 22.4
BB	.85 - 1.01	21.6 - 25.7
C	.92 - 1.08	23.4 - 27.4
D	1.04 - 1.20	25.4 - 30.5

3 Compression Lugs | Conductor Size (Aluminum or Copper)

Code	Str/Comp	Compact	Solid
2	2	1	1
10	1/0	2/0	2/0
20	2/0	3/0	3/0
30	3/0	4/0	4/0
40	4/0	250	250

4 Jacket Sealing

Code	Type
Blank	No Jacket Seal
ES	Integral Jacket Seal

Ratings	15 kV	25 kV
Minimum Partial Discharge	11	19
Max Rating Phase-to-Ground	8.3	15.2
Max Rating Phase-to-Phase	14.4	26.3
AC 60 Hz 1 Minute Withstand (rms)	34	40
DC 15 Minute Withstand	53	78
BIL and Full Wave (Crest)	95	125

RELATED TEST REPORT:

EDR-5574 (15 kV)
EDR-5581 (25 kV)

Elbow Kit Contents:

- Elbow body
- Copper top terminal
- Loadbreak probe
- Silicone lubricant
- Installation instructions sheet
- Probe installation tool
- Sealing mastic (integral seal only)

Elbow Sealing and Grounding

FEATURES

- Grounding kits include a constant-force ground clamp and solder-blocked ground braid for external grounding
- Kits available with either heat shrink or cold applied seals

APPLICATIONS

- Sealing and grounding kits for Copper Tape (CT) Shield cables when installing 200A and 600A Elbows or other Shielded Cable Accessories.

BENEFITS

- ♦ Multiple part numbers to satisfy most grounding and sealing needs
- Used to seal and secure ground braids for most shielded cables

PRODUCT SELECTION INFORMATION: DIMENSIONS IN INCHES (MM)

Catalog Number	Outside Diameter Minimum Insulation Shield	Maximum Cable Jacket	Voltage Class (kV)	Conductor Size
ELB-35-600 Series comes with a heat shrink seal				
ELB-35-600-GRD1	0.65 (17)	1.50 (38)	5	#2-500
			15	#2-500
			25	#1-3/0
ELB-35-600-GRD2	1.30 (33)	2.50 (63)	5	600-1000
			15	350-1000
ELB-35-600-GRD3	1.30 (33)	2.50 (63)	25	4/0-1000
			35	1/0-1000

Catalog Number	Cable Size 15 kV Class	Cable Size 25 kV Class	Cable Size 35 kV Class	Minimum Seal Diameter	Minimum Installed Diameter
Grounding Kit with Cold Applied Seal					
ELB-600-CES-GRD-1	2 - 4/0 AWG	2 - 2/0 AWG	1/0 AWG	0.95	1.94
	(35 - 100 mm ²)	(35 - 50 mm ²)	(60 mm ²)	(24)	(49)
ELB-600-CES-GRD-2	2/0 - 1000 kcmil	1/0 AWG - 750 kcmil	1/0 AWG - 500 kcmil	1.28	2.67
	(70 - 500 mm ²)	(60 - 380 mm ²)	(60 - 250 mm ²)	(33 mm)	(68 mm)
ELB-600-CES-GRD-3	750 - 1500 kcmil	600 - 1250 kcmil	350 - 1250 kcmil	1.60	3.50
	(380 - 725 mm ²)	(325 - 625 mm ²)	(180 - 625 mm ²)	(41 mm)	(89 mm)

Catalog Number	Cable Size 15 kV Class	Cable Size 25 kV Class	Insulation Diameter (min-max)
Grounding Kit (no seal)			
ELB-200-GRD-1	2 - 4/0 AWG	2 - 2/0 AWG	0.5 - 1.0
	(35 - 100 mm ²)	(35 - 100 mm ²)	(13-25 mm)
ELB-200-GRD-2			
Grounding Kit with Cold Applied Seal			
ELB-200-CES-GRD-1	2 - 4/0 AWG	2 - 2/0 AWG	0.5 - 1.0
	(35 - 100 mm ²)	(35 - 100 mm ²)	(13-25 mm)

ADDITIONAL PRODUCT INFORMATION

- Reference the conductor size to verify proper sealing kit for selection.
- ELB-600 and ELB-200 series are suitable for use with 600A or 200A elbows.

Bushing Inserts Loadbreak

FEATURES

- High quality peroxide-cured EPDM insulation
- Includes grounding tabs to attach a drain wire to maintain dead-front safety
- Provides insulated, fully shielded, submersible connection
- Conforms to ANSI/IEEE Standard 386

APPLICATIONS

- TE's Raychem 200A Loadbreak Bushing Insert is available in 15 kV and 25 kV classes. The bushing insert connects to a universal bushing well and is used in field installation and replacement of loadbreak elbows.

BENEFITS

- ♦ Bushing insert and elbow connectors provide fully shielded, submersible connection with conformance to IEEE Standard 386.
- ♦ Interchangeable with other manufacturers' products that also comply with this standard.
- ♦ Version with yellow indicator ring provides the installer a visual indication the elbow is properly seated on the bushing insert.



Current Ratings	A rms
Continuous Current	200
Switching Current	200
Fault-closure Current for 0.17s after 10 Switching Operations	10,000 symmetrical
Short-time Current for 0.17s	10,000 symmetrical
Short-time Current for 3.00s	3,500 symmetrical

Voltage Ratings	15 kV	25 kV
Minimum Partial Discharge	11	19
Max Rating Phase-to-Ground	8.3	15.2
Max Rating Phase-to-Phase	14.4	26.3
AC 60 Hz 1 Minute Withstand (rms)	34	40
DC 15 Minute Withstand	53	78
BIL and Full Wave (Crest)	95	125

PRODUCT SELECTION INFORMATION:

Catalog Number	Product Description	Voltage Class	Current Rating (A)
ELB-15-200-BI	15 kV Bushing Insert	15 kV	200
ELB-25-200-BI	25 kV Bushing Insert	25 kV	200
ELB-15-200-BI-IND	15 kV Bushing Insert with Indicator Ring	15 kV	200
ELB-25-200-BI-IND	25 kV Busing Insert with Indicator Ring	25 kV	200

RELATED TEST REPORTS

EDR-5576 (15 kV), EDR-5580 (25 kV)

200A Insulating Cap

FEATURES

- Provides insulated, fully shielded, submersible connection
- Conforms to the ANSI/IEEE Standard 386

APPLICATIONS

- TE's Raychem 200A Insulating Cap is available in 15/25/35 kV class.
- The insulating cap is meant to provide insulated, submersible protection for energized 15/25/35 kV loadbreak interfaces.
- They can be used temporarily or permanently within padmount cabinets, underground vaults, switchgear, transformers, and a variety of other apparatus.
- Typical applications include system maintenance, a circuit reconfiguration, and future expansion.

BENEFITS

- ♦ Maintains ground potential on the cap's surface when the drain wire is connected to a common ground
- ♦ These insulating caps are therefore interchangeable with other manufacturers' products that also comply with IEEE standard 386.



Voltage Ratings	15 kV	25 kV	35 kV
Minimum Partial Discharge	11	19	26
Max Rating Phase-to-Ground	8.3	15.2	21.1
Max Rating Phase-to-Phase	14.4	26.3	N/A
AC 60 Hz 1 Minute Withstand (rms)	34	40	50
DC 15 Minute Withstand	53	78	103
BIL and Full Wave (Crest)	95	125	150

PRODUCT SELECTION INFORMATION

Catalog Number	Attributes	Voltage Class (kV)	Current Rating
ELB-15-200-IC	15 kV Insulating Cap	15 kV	200
ELB-25-200-IC	25 kV Insulating Cap	25 kV	200
ELB-35-200-IC21	35 kV Insulating Cap (1ph Rated)	35 kV	200

RELATED TEST REPORTS

EDR-5575 (15 kV), EDR-5579 (25 kV)

ETP Elbow Tap Plug

FEATURES

- Internal threads which accept the stud from the 200A elbow
- Available in 15/28/35 kV on the 600A side and 15/25 kV on the 200A side
- High quality peroxide cured EPDM rubber insulation

APPLICATIONS

- TE's Raychem Elbow Tap Plug (ETP) provides a transition from a 600A deadbreak elbow to a 200A loadbreak interface.
- This interface allows for live testing or the addition of a 200A loadbreak tap, elbow arrester or grounding elbow.

BENEFITS

- A fully shielded, submersible connection is offered with conformance to IEEE Standard 386.
- TE ETPs are interchangeable with other manufacturers' products that comply with this standard.



Ratings		
Voltage Class - 600A Side (kV)	AC 1 minute Withstand (kV rms)	Minimum Corona Level (kV rms)
15	34	11
28	40	19
35	50	26

Current Ratings	
Description	A rms
Continuous Current	200
Switching Current	200
Fault-closure Current for 0.17s after 10 Switching Operations	10,000 symmetrical
Short-time Current for 0.17s	10,000 symmetrical
Short-time Current for 3.00s	3,500 symmetrical

RELATED TEST REPORTS

EDR 5575 (15 kV), EDR 5579 (25 kV)

Voltage Ratings			
Description	15 kV	28 kV	35 kV
Minimum Partial Discharge	11	19	26
Max Rating Phase-to-Ground	8.3	15.2	21.1
Max Rating Phase-to-Phase	14.4	26.3	N/A
AC 60 Hz 1 Minute Withstand (rms)	34	40	50
DC 15 Minute Withstand	53	78	103
BIL and Full Wave (Crest)	95	125	150

PRODUCT SELECTION INFORMATION

Catalog Number	Attributes	Voltage Class (kV)	Current Rating (A)
ELB-15/28-200-ETP15	15/28 kV (600) - 15 kV (200) 3ph rated ETP	15/28 kV	200
ELB-15/28-200-ETP25	15/28 kV (600) - 28 kV (200) 3ph rated ETP	15/28 kV	200
ELB-35-200-ETP21	35 kV (600) - 21 kV (200) 1ph rated ETP	35 kV	200

LRTP Loadbreak Reducing Tap Plug

FEATURES

- Rotating nut which threads onto apparatus bushing or 200A elbow
- Allows for hotstick control of the elbow and its connections
- Available in 15/28/35 kV on 600A side and 15/25 kV on 200A side
- High quality peroxide cured EPDM rubber insulation
- A fully shielded, submersible connection is offered with conformance to IEEE Standard 386.

APPLICATIONS

- TE's Raychem Loadbreak Reducing Tap Plug (LRTP) provides a transition from a 600A deadbreak elbow to a 200A loadbreak interface.
- This interface allows for live testing or the addition of a 200A loadbreak tap, elbow arrester or grounding elbow.

BENEFITS

- ♦ Using a 5/16 inch Hex wrench, the LRTP is installed into a 600A deadbreak elbow that utilizes a threaded copper-top lug.
- ♦ When proper installation torque is reached, pins shear releasing the inner threaded stud that is used to complete the installation to the apparatus bushing, resulting in a one-piece interface.
- ♦ TE's Raychem LRTP tap plugs are interchangeable with other manufacturers' products that comply with IEEE 386.

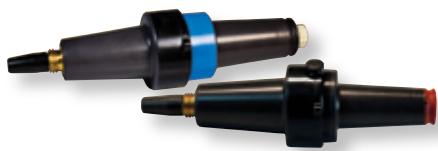

Current Ratings	A rms
Continuous Current	200
Switching Current	200
Fault-closure Current for 0.17s after 10 Switching Operations	10,000 symmetrical
Short-time Current for 0.17s	10,000 symmetrical
Short-time Current for 3.00s	3,500 symmetrical

Voltage Ratings	15 kV	28 kV	35 kV
Minimum Partial Discharge	11	19	36.6
Max Rating Phase-to-Ground	8.3	15.2	21.1
Max Rating Phase-to-Phase	14.4	26.3	N/A
AC 60 Hz 1 Minute Withstand (rms)	34	40	50
DC 15 Minute Withstand	53	78	103
BIL and Full Wave (Crest)	95	125	150

PRODUCT SELECTION INFORMATION

Catalog Number	Attribute	Voltage Class (kV)	Current Rating (A)
ELB-15/28-200-LRTP15	15/28 kV (600) - 15 kV (200) 3ph rated LRTP	15/28 kV	200
ELB-15/28-200-LRTP25	15/28 kV (600) - 28 kV (200) 3ph rated LRTP	15/28 kV	200
ELB-35-200-LRTP21	35 kV (600) - 21 kV (200) 1ph rated LRTP	35 kV	200

RELATED TEST REPORT:
EDR 5575 (15 kV), EDR 5579 (25 kV)

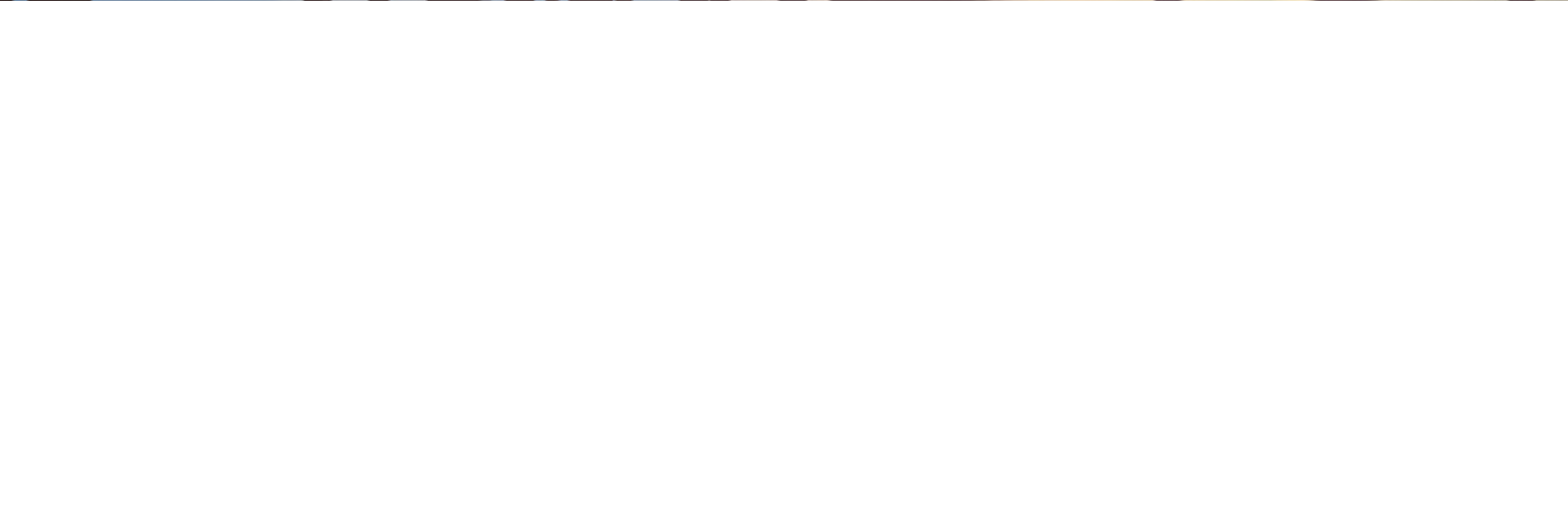



Chapter 5

High Voltage Cable Accessories & Insulators

Splices, Terminations & Accessories	214
Tools	224
High Voltage Insulators	226

High Voltage Torque Controlled Connectors and Lugs

FEATURES

- Fast and safe installation
- Excellent electrical performance
- Excellent mechanical performance
- Easy installation with socket wrench
- Pre-engineered design for perfect fit
- Cu and Al conductors
- Body made of aluminum alloy
- Variety of different palms available
- Lug body made of tinned aluminum alloy

APPLICATIONS

- Suitable for up to 1600 mm²
- Straight and size transition type connectors

BENEFITS

- ♦ The connector design allows cables to be spliced/terminated without special tools, heat treatment or filing after installation.
- ♦ Shearhead bolts ensure a pre-engineered electrical connection.
- ♦ The shearhead bolts break off at a predetermined level below the outer surface of the connector, at a defined torque. This ensures the correct contact pressure is reached every time. Oxide-breaking and corrosion prevention is performed by the contact grease inside the body.



PRODUCT SELECTION INFORMATION: DIMENSIONS IN INCHES (MM)

Cable Lug with 1-hole Palm NEMA Pad (EPPA-071-x/y)	
L	6.54 (166.2)
A	3 (76.2)
B	1.5 (38.1)
D	.56 (14.2)
E	.98 (25)
F	2.68 (68)
X = Conductor Diameter, Y = Insulation Diameter	

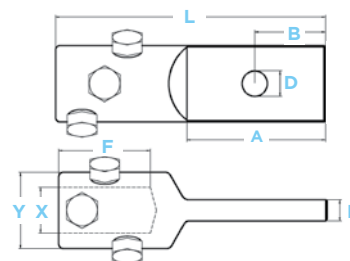

Cable Lug with 2-Hole Palm NEMA Pad (EPPA-072-x/y)	
L	6.54 (166.2)
A	3 (76.2)
B	.63 (15.9)
C	1.75 (44.5)
D	.56 (14.2)
E	.98 (25)
F	2.68 (68)
X = Conductor Diameter, Y = Insulation Diameter	

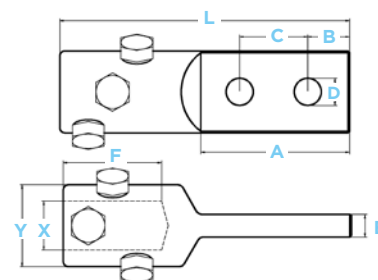

Cable Lug with Rod	
ROD ø 30 mm (EPPA-050-X/Y)	
L	7.48 (190)
A	3.94 (100)
F	2.52 (64)
ø	1.18 (30)
ROD ø 40 mm (EPPA-053-X/Y)	
L	10.39 (264)
A	4.92 (125)
F	4.02 (102)
ø	1.57 (40)
ROD ø 50 mm (EPPA-061-X/Y)	
L	10.39 (264)
A	4.92 (125)
F	4.19 (106.5)
ø	1.97 (50)
X = Conductor Diameter, Y = Insulation Diameter	

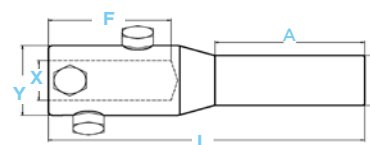

PRODUCT SELECTION INFORMATION: DIMENSIONS IN INCHES (MM)

TB1

Cable Lug with 4-Hole Palm NEMA Pad (EPPA-054-X/Y)	
Contact plate: EPPA-054-X/Y	
4 in. x 4 in. (101.6 mm x 101.6 mm)	
L	9.2 in. (234 mm)
A	4 in. (101.6 mm)
B	1.13 in. (28.6 mm)
E	.98 in. (25 mm)
C	1.75 in. (44.5 mm)
D	.56 in. (14.3 mm)
F	4.53 in. (115 mm)
X, Y according to the cable dimensions	

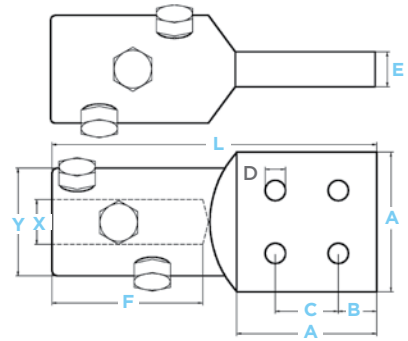

TB2

Cable Lug with 6-Hole Palm NEMA Pad (EPPA-076-X/Y)	
Contact plate: 4 in. x 6 in. (101.6 mm x 152.4 mm)	
L	11.2 in. (285 mm)
W	4 in. (101.6 mm)
B	1.25 in. (31.8 mm)
E	.98 in. (25 mm)
C	1.75 in. (44.5 mm)
D	.56 in. (14.3 mm)
F	4.53 in. (115 mm)
A	6 in. (152.4 mm)
X, Y according to the cable dimensions	

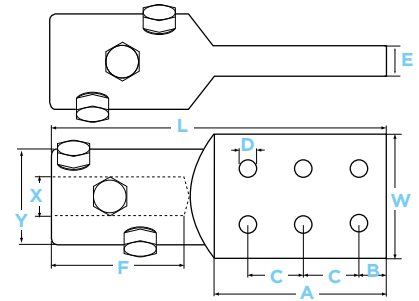

TB3

Mechanical Connector for Straight Connection (EPPA-047-X/Y-L)	
L	5.12 in. (130 mm)
L	7.09 in. (180 mm)
L	L = 9.06 in. (230 mm)
X, Y according to the cable dimensions	

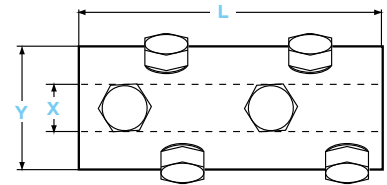

TB4

Mechanical Connector for Size Transition (EPPA-047-X1/Y1-X2/Y2-L)	
L	5.12 in. (130 mm)
L	7.09 in. (180 mm)
X1, X2 = Conductor Diameter Y1, Y2 = Insulation Diameter	

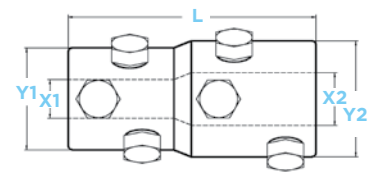

TB5

Mechanical Connector for Cables with Small Insulation Thickness (EPPA-063-X1/Y1-X2/Y2-L)	
L	7.09 in (180 mm)
L	9.06 in (230 mm)
X1, X2 = Conductor Diameter Y1, Y2 = Insulation Diameter	

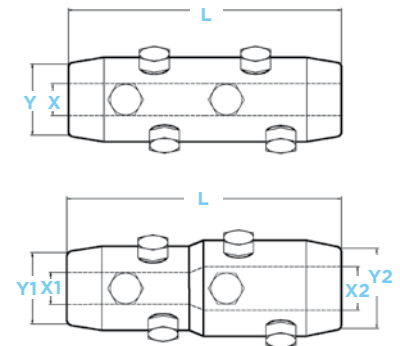

EHVS-69 Splices for 1/C Shielded Cable (46 and 69 kV)

FEATURES

- 69 kV splice incorporates a connector that allows large cross sections to be joined without special tools, heat treatment, or filing off after installation, thus reducing outage time.
- Minimum installation space required is 84.0 inches.
- Allows In-Line and/or Shield Break Grounding Connection of the metallic shields.

APPLICATIONS

- For use on wire shield, wire metallic tape shield, and metallic sheathed power cables.

BENEFITS

- A complete line of TE's Raychem splice kits for conductor sizes ranging from 4/0-3000 kcmil.
- TE sizes the EHVS splice to your application. You simply fill out an EHVS information sheet (available from your TE representative). Based on the information you provide (conductor, insulation, and jacket diameters), we will machine a connector to fit your cable and supply you with a kit containing both the connector and the EHVS splice for your cable.



PRODUCT SELECTION INFORMATION: DIMENSIONS IN INCHES (MM)

Catalog Number*	Nominal Cable Range		Jacket O.D. (Max)	Insulation Diameter Range
	69 kV	46 kV		
EHVS-6920-W-CXXX	1/0-3/0 AWG	250-500 kcmil	2.00 (51)	1.35-1.75 (34-44)
EHVS-6921-W-CXXX	2/0-500 kcmil	600-1000 kcmil	2.85 (72)	1.70-2.35 (43-60)
EHVS-6922-W-CXXX	600-1000 kcmil	1250-2000 kcmil	3.00 (76)	2.05-2.55 (52-55)
EHVS-6923-W-CXXX	1250-3000 kcmil	3000 kcmil	4.17 (106)	2.50-3.39 (63-86)

*-CXXX denotes the connector information that will be known once cable specs are provided. See Note 1 below.

ADDITIONAL PRODUCT INFORMATION

- Contact your local TE representative for the appropriate part number to order. To help us supply the correct product; the following information is required: conductor, insulation, and jacket diameters.
- Each splice comes supplied with a shear bolt connector manufactured to your cable dimensions.
- EHVS-692x-W-CXXX is a standard Inline splice kit. For shield break option, please add -SB- after "W" in the part number.
- Related test report: 46/69 kV: PPR 1010, EDR-5228, EDR-5228, EDR-5421
- Rated and qualified at IEEE Std 404 and IEC 60840

EHVT-46 | 69 Termination for 1/C Shielded Power Cable

FEATURES

- High-contamination withstand and non-tracking. The unique high-voltage insulating sleeve is a field-proven, nontracking, and erosion-resistant material that does not require periodic cleaning. The material properties have been formulated to be thermally stable and highly resistant to UV degradation, weathering, and environmental pollution.
- Positive environmental seal
The cable, along with external ground, is sealed from moisture ingress using TE's proven high-voltage, heat-activated scaling system. No field engineering or additional accessory kits are required.
- Qualified to IEC 60840 and IEEE-48, Class 1 for outdoor (weather-exposed) use.

APPLICATIONS

- For use on wire shield, wire/metallic-tape shield, lead sheath, and jacketed concentric neutral cables (46 and 69 kV). Both kits contain a limited number of lightweight components with unlimited shelf life under normal storage conditions.

BENEFITS

- Because the 46 and 69 kV HVT kits use standard heat shrink components, guide tubes are not needed for alignment, elastomer compression, computed venting, or field compound filling. Only standard cable support systems are needed, reducing steel structure or pole top support requirements.
- TE's Raychem EHVT series high-voltage terminations utilize a stress control system that has been field-proven since the 1980's.



PRODUCT SELECTION INFORMATION: DIMENSIONS IN INCHES (MM)

Catalog Number		Conductor Size (AWG/kcmil)	Insulation Diameter (min - max)	Jacket O.D. (max)
Indoor	Outdoor			
46 kV 32(813)				
40(1016)				
EHVT-462-G	EHVT-462-SG	#2-4/0	1.18-1.77 (30-45)	2.36 (60)
EHVT-463-G	EHVT-463-SG	250-750	1.47-2.05 (38-52)	2.75 (70)
EHVT-464-G	EHVT-464-SG	1000-1500	1.97-2.56 (50-65)	3.35 (85)
EHVT-465-G	EHVT-465-SG	1750-3000	2.48-3.39 (63-86)	4.17 (106)
69 kV 42(1067)				
52(1321)				
EHVT-691-G	EHVT-691-SG	1/0-350	1.50-2.05 (38-52)	2.65 (67)
EHVT-690-G	EHVT-690-SG	1/0-4/0	1.18-1.77 (30-45)	2.36 (60)
EHVT-692-G	EHVT-692-SG	350-1000	1.95-2.55 (50-65)	3.25 (83)
EHVT-693-G	EHVT-693-SG	1000-2000	2.50-3.39 (64-86)	4.17 (106)
EHVT-694-G	EHVT-694-SG	2000-3000	2.76-3.38 (70-86)	4.33 (110)

ADDITIONAL PRODUCT INFORMATION

- Select the appropriate catalog number. Selections are based on the typical dimensions of 100% insulated cables and the dimensions of commonly used connectors manufactured in accordance with AEIC standard. Nominal insulation thickness (100%): 46 kV: 420 mils, 69 kV: 650 mils.
- For cables manufactured to other specifications, confirm selection with cable dimensions.
- Kits do not contain connectors; order connectors separately.
- Related test report: 46 kV: PPR-1085, 69 kV: EDR-5241
- TE's Raychem Cable Clamps CC available to accommodate cable diameters from 2.5-4.17 inches (65-106 mm).
- EHVT-BP base plates for mounting the Cable Clamps CC are also available.

EHVS-T Three-Piece Splice

FEATURES

- Torque-controlled connector
- Splice fits on all polymeric cable constructions
- Proven shield continuity concept
- Short cut-back dimensions
- No special tools required to install the splice
- Cable size transition possible
- No tension set of splice body
- Moulded outer conductive screen
- Geometrical electrical stress control by moulded conductive deflectors
- Type tested according to IEC 60840 and IEEE 404 Standards
- Manufactured according to ISO 9001 and ISO 14001

APPLICATIONS

- TE's Raychem splice is a pre-fabricated three piece design for voltage classes up to 138 kV.

BENEFITS

- ♦ Polymeric insulated cables of various designs can be adapted with respect to shielding and metal sheath.
- ♦ The silicone rubber joint parts with integrated geometrical stress control provides proven electrical function.
- ♦ The splice components combine electrical performance, stress control and moisture sealing to provide the important functions required for all high voltage products.
- ♦ Special silicone rubber provides perfect compression force for optimized electrical performance



ADDITIONAL PRODUCT INFORMATION

TECHNICAL DATA		138 kV
Rated voltage U ₀ /U (U _m)	kV	76/132 (145)
Basic impulse level	kV	650
Max. continuous operating temperature	°C	90
Max. conductor emergency temperature	°C	150
Conductor short circuit temperature	°C	250
Short circuit current (sheath)	kA / 1sec	50
For Shield Break Joints		
DC voltage between metallic sheaths/screens	kV	20
DC voltage between metallic sheath/screen and earthed exterior	kV	20
Lightning impulse voltage between metallic sheath/screen	kV	75
Lightning impulse voltage between metallic sheath/screen and earthed exterior	kV	37.5
Application Range		
Conductor up to	kcmil	3000
Diameter over Insulation	inch (mm)	1.69-3.66 (43-93)

For special applications and bigger cable sizes please contact your TE representative.

EHVS-S One-Piece Splice

FEATURES

- Premoulded one-piece joint body
- Torque-controlled connector
- Choice of outer sealing and protection systems
- Splice fits on all polymeric cable constructions
- Proven shield continuity concept
- Simple assembly
- No tension set of joint body
- Moulded thick outer conductive screen
- Geometrical electrical stress control by moulded conductive deflectors
- Type tested according to IEC 60840, IEC 62067, GB 11017 Standards
- Manufactured according to ISO 9001 and ISO 14001

APPLICATIONS

- TE's Raychem EHVW-S splice is a pre-fabricated one-piece design for voltage classes up to 230 kV.

BENEFITS

- ♦ Polymeric insulated cables of various designs can be adapted with respect to shielding and metal sheath.
- ♦ The silicone rubber joint body with integrated geometrical stress control provides proven electrical function.
- ♦ The splice components combine electrical performance, stress control and moisture sealing to provide the important functions required for all High Voltage products.
- ♦ Special silicone rubber provides perfect compression force for optimized electrical performance



ADDITIONAL PRODUCT INFORMATION

TECHNICAL DATA		138 kV	230 kV
Rated voltage U ₀ /U (Um)	kV	76/132 (145)	127/220 (245)
Basic impulse level	kV	650	1050
Max. continuous operating temperature	°C	90	90
Max. conductor emergency temperature	°C	150	150
Conductor short circuit temperature	°C	250	250
Short circuit current (sheath)	kA / 1sec	50	50
Application Range			
Conductor	kcmil	2250	5000
Diameter over Insulation	inch (mm)	2.20-3.07 (56-78)	2.80-4.69 (71-119)

For special applications and bigger cable sizes please contact your TE Connectivity representative.

OHVT Oil-Filled Outdoor Termination

FEATURES

- Composite or porcelain housings with different creepage lengths are available covering the most common and extreme pollution levels
- The termination is designed according to following standards: IEC-60840, IEC-62067, IEC-60815, IEEE-48, IEEE-1313.

APPLICATIONS

- TE's Raychem OHVT high voltage outdoor termination system is designed for voltage up to 230 kV and to operate under severe environmental conditions

BENEFITS

- Polymeric insulated cables of various designs can be adopted with respect to shielding and metal sheath.
- The installation of the termination can be done by trained installer equipped with conventional tools.

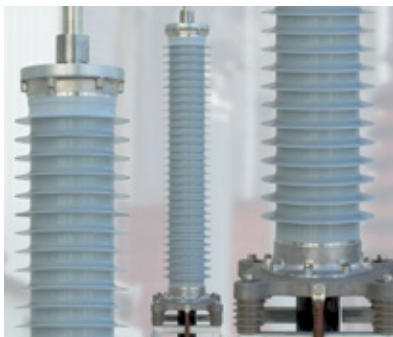

ADDITIONAL PRODUCT INFORMATION

TECHNICAL DATA		69 kV	138 kV	170 kV	230 kV
Rated voltage U ₀ /U (Um)	kV	36/69 (72.5)	76/132 (145)	87/161 (170)	127/220 (245)
Basic impulse level	kV	325	650	750	1050
Max. continuous operating temperature	°C	90	90	90	90
Max. conductor emergency temperature	°C	150	150	150	150
Conductor short circuit temperature	°C	250	250	250	250
Short circuit current (sheath)	kA / 1sec	50	50	50	50
Creepage (Pollution class IEC 60815)		a-e	a-e	a-e	a-e
Withstand voltage support insulators (AC/DC)	kV	10/20	10/20	10/20	10/20
Application Range					
Conductor	kcmil	5000	5000	5000	5000
Diameter over Insulation: Composite	inch (mm)	1.34-3.82 (34-97)	1.34-3.82 (34-97)	1.34-4.25 (34-108)	2.80-4.69 (71-119)
Diameter over Insulation: Porcelain	inch (mm)	1.34-2.91 (34-74)	1.34-2.91 (34-74)	—	2.80-4.69 (71-119)
Diameter over sheath	inch (mm)	4.33 (110)	4.33 (110)	4.69 (119)	6.30 (160)

All listed dimensions are standard size to serve the common application of these terminations. For special applications and bigger cable sizes please contact your TE representative.

OHVT-D Dry Self-Supporting Outdoor Termination

FEATURES

- Free from any insulating liquid or gel
- Polymeric insulated cables of various designs can be adopted with respect to shielding and metal sheath.
- Its mechanical performance is similar to conventional oil-filled terminations with composite housing.
- The termination is easily separable and consists of a plug-in part and an epoxy resin insulator protected with a directly moulded silicone shed housing.
- Dry interface, no oil-filling
- Self-supporting
- Pre-fabricated and factory tested silicone-rubber stress cone
- Torque-controlled multi-contact conductor bolt
- Long creepage length
- Type tested according to IEC 60840

APPLICATIONS

- TE's Raychem OHVT-D dry self-supporting termination is designed for voltage class 138 kV and operation under severe environmental conditions.

BENEFITS

- ♦ Due to the short cable cut-back dimensions of the plug-in, the time required to install the termination is very short and can be further reduced in case of short cable links by pre-installing the plug-in on the shop floor.
- ♦ The plug-in is similar to the plug-in used with our dry switchgear/transformer termination.
- ♦ Fast and simple installation combining GIS plug-in technology with polymeric insulators
- ♦ No special tools required to install the termination
- ♦ Isolated cable gland for sectionalization
- ♦ The polymeric housing with long creepage length covers extreme pollution levels according to IEC 60071-1 1996, IEC 60071-2 1996 and IEEE-1313.1-1996.

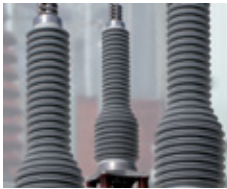

PHVS/PHVT Dry Compact Switchgear and Transformer Termination

FEATURES

- Complies with IEC 62271-209 standard, which essentially specifies the interfaces between the termination and the switchgear. Therefore the termination will fit into all GIS complying with IEC 62271-209.
- Dry interfaces, no oil-filling
- Dimensions comply with pressure-tight resin housing
- Operates in SF6 and insulating liquids
- Pre-fabricated and factory tested Si-rubber stress cone
- Torque-controlled multi-contact conductor bolt
- No special tools required to install the termination
- Isolated cable gland for sectionalization
- Type tested according to IEC 60840, IEC 62067 and IEC 62271-209 standards

APPLICATIONS

- TE's Raychem PHVS/PHVT dry compact switchgear termination for voltage classes up to 230 kV is designed to be installed in cable entry housings of gas-insulated switchgear (GIS).

BENEFITS

- ♦ The termination is easily separable and consists of a plug-in part and an epoxy resin insulator.
- ♦ The insulator can be installed by the GIS or transformer manufacturer already at the factory saving installation time on-site and reducing the risk of contamination of the cable entry housing.
- ♦ In case of short cable links and due to the short length and light weight of the plug-in part it can be also pre-installed by the cable manufacturer further reducing the time required to install a substation.



Adapters are available to match the dimensions of wet (oil-filled) type terminations, and older designs specified in IEC 60859. The termination operates in SF6 but also in insulating liquids like transformer oil. A corona shield at the top of the termination then provides the necessary shielding of the terminal.

Link Boxes Cross for High-Voltage Cable Systems

FEATURES

- IP-56 rated.
- Can be installed on poles and other above ground structures (not for submersible applications)
- Use with single core lead
- Cross section up to 250 kcmil with IP-56
- Direct grounding
- Single point bonding
- Cross bonding and transposition
- Sheath voltage limiters (SVL) 1 kV up to 8 kV, tested as IEC 60099
- Short circuit rate up to 50 kA @ 1 sec.

APPLICATIONS

- Lightning, fault currents and switching operations can cause overvoltages on the cable sheath. Link boxes are used with cable joints and terminations to provide easy access to shield breaks for test purposes and to limit voltage build-up on the sheath.
- The link box optimizes loss management in the cable shield on cables grounding both sides.

BENEFITS

- ♦ Tested to ANSI/IEEE Std. 575.
- ♦ Overvoltage management on cable system.
- ♦ Protects cable from damage caused by induced voltage and current.
- ♦ CIGRE/ELECTRA recommendations for cross bonding (Larger cable cross sections on request)

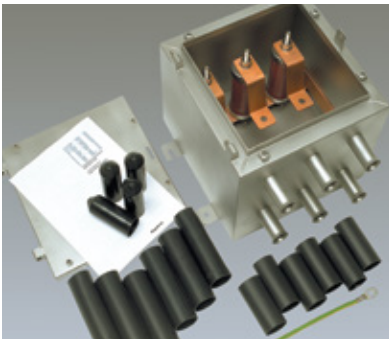

PRODUCT SELECTION INFORMATION: DIMENSIONS IN INCHES (MM)

Catalog Number	Reference Application	Sheath Voltage Limiter	Number of Phases	Dimensions		
				L	W	H
EPPA-055-0/1	Direct grounding	---	1	11.81 (300)	7.48 (190)	6.50 (165)
EPPA-055-3/1	Cross bonding	3 kV	1	11.81 (300)	7.48 (190)	6.50 (165)
EPPA-055-6/1	Cross bonding	6 kV	1	11.81 (300)	7.48 (190)	6.50 (165)
EPPA-055-0/3	Direct grounding	---	3	12.20 (310)	12.20 (310)	10.04 (255)
EPPA-055-3/3	Cross bonding	3 kV	3	12.20 (310)	12.20 (310)	10.04 (255)
EPPA-055-6/3	Cross bonding	6 kV	3	12.20 (310)	12.20 (310)	10.04 (255)

ADDITIONAL PRODUCT INFORMATION

Test Reports: PPR 1168 Type Test of Link Box LBOX3-ZnO-3
PPR 1449 Type Test of Link Box EPPA-055-6/3

HVLB Link Boxes for High-Voltage Cable Systems

FEATURES

- IP-68 rated.
- Can be installed above ground and in submersible conditions (tested under 5 m water head).
- Use with concentric and single core bonding lead.
- Cross section up to 600 kcmil with IP 68 link boxes.

APPLICATIONS

- Lightning, fault currents and switching operations can cause overvoltages on the cable sheath. Link boxes are used with cable joints and terminations to provide easy access to shield breaks for test purposes and to limit voltage build-up on the sheath.
- The link box optimizes loss management in the cable shield on cables grounding both sides.

BENEFITS

- ♦ Tested to ANSI/IEEE Std. 575. Guide for the application of sheath-bonding methods for single conductor cables and the calculation of induced voltages and currents in cable sheaths.
- ♦ CIGRE/ELECTRA recommendations for cross bonding (Larger cable cross sections on request)



PRODUCT SELECTION INFORMATION: DIMENSIONS IN INCHES (MM)

Catalog Number	Reference Application	Number of Phases	Sheath Voltage Limiter	Dimensions		
				L	W	H
HVLB-E-S-X-1-Y-U-IP68-B-Z	Grounding with SVL	1	1 kV up to 8 kV	496 (19.35)	451 (17.76)	322 (12.68)
HVLB-E-S-X-3-Y-U-IP68-B-Z	Grounding with SVL	3	1 kV up to 8 kV	496 (19.35)	795 (28.54)	322 (12.68)
HVLB-E-S-O-1-Y-U-IP68-B-Z	Direct Grounding	1	-	496 (19.35)	451(17.76)	322 (12.68)
HVLB-E-S-O-3-Y-U-IP68-B-Z	Direct Grounding	3	-	496 (19.35)	795 (28.54)	322 (12.68)
HVLB-C-S-X-6-Y-U-IP68-B-Z	Cross Bonding	3	1 kV up to 8 kV	680 (26.77)	740 (29.13)	392 (15.43)

PPR-2334, PPR2914, PPR-382, type Test Report of Link Box HVLB: PPR-2332, PPR-2334, PPR-2194, PPR-3082

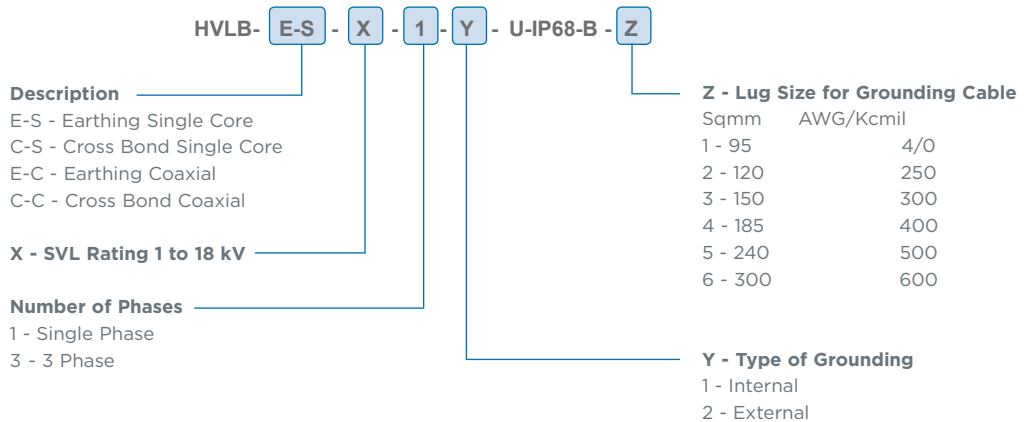

Termination Lifting Device Outdoor Termination

FEATURES

- Simplifies placement and mounting onto the rack on the pylon
- Applicable for all TE terminations up to 138 kV
- Adjustable to all common cable sizes up to a diameter over cable sheath of 110 mm
- Easy assembly and handling

APPLICATIONS

- The Lifting Device ensures a safe and easy installation of TE's outdoor terminations on high positioned mounting places

BENEFITS

- ♦ The installer can do the complete installation of the termination on the ground including the oil filling and then lifting up the termination to the high positioned mounting place.
- ♦ Mounting the termination onto the rack is the only work step the installer has to do on the pylon.



EHVT-BP Cable Mounting Base Plate

FEATURES

- The plate comes suitably drilled for attaching to supporting steelwork or cross arms that have been drilled to accept steelwork for various porcelain insulator type terminations

APPLICATIONS

- The base plate is a galvanized steel plate intended for use with TE heat shrink EHV/GHVT terminations together with TE's Raychem cable clamps support brackets.

BENEFITS

- ♦ It is especially useful when retrofitting old porcelain terminations with heat shrink terminations.
- ♦ It has suitable spaced slots to accommodate two TE Raychem cable clamp support brackets.

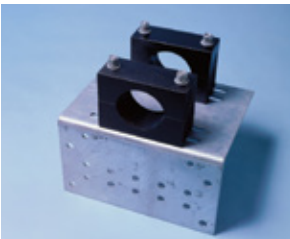

PRODUCT SELECTION INFORMATION

Catalog Number	Reference Application
EHVT-BP	1 base plate per box

HVIA-Stripper 35/90-US:

Stripping tool for cable semicon and primary insulation for cable diameters from 1.37-3.54 inches (35-90 mm)

HVIA-Stripper 75/150-US:

Stripping tool for cable semicon and primary insulation for cable diameters from 2.95-5.90 inches (75-150 mm)

Replacement blades for HVIA-Stripper

EXRM-0982-I-22.5 for removing insulation layer
EXRM-0982-R-20-4 for removing semi-conductor layer

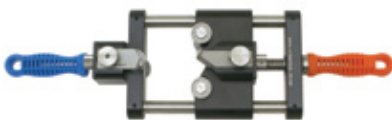

High Voltage Heating Blanket | Slide Rails with Clamps



HVIA-CABLE-HEATING-BLANKET:
Cable heating blankets



Screw Clamps
Accessory to Heating Blanket



HVIA-SLIDE-RAIL-1580:
Slide rail

Station Post Insulators

FEATURES

- TE's Axicom Composite Insulators have been in service worldwide since the 1980s as important components of high voltage apparatus.
- Full range of ANSI C29.9 qualified TR station post insulators to cover 95kV to 1800kV BIL requirements. Manufactured to offer both standard and custom options to fulfil any environmental, electrical and mechanical substation requirements.

APPLICATIONS

- Axicom insulators are used for circuit breakers, instrument transformers, cable terminations and other components in high voltage substations utilizing this advanced technology for voltages up to 800 kV.
- Porcelain station-post insulators are used to support the electrical bus system within a substation and provide mechanical support to electrical equipment like disconnect switches and capacitor banks.

BENEFITS

- ♦ Axicom insulators provide superior performance under heavy contamination and in areas under seismic threat. These insulators can change a normal air insulated substation into a "minimum maintenance substation".
- ♦ Demonstrated reliable performance in various types of applications all over the world to go along with over 95 years of service experience in electric power supply.



Composite Station Post Insulators

Code	Technical Reference Number	Highest System Voltage	Impulse Withstand (BIL)	Low-frequency Wet Withstand	Weight	Height (H)	Leakage Distance (L)	Arching Distance (SW)	Cantilever Strength	Deflection at 40% c. Strength	Tensile Strength	Compression Strength	Torsional Strength
SPI-		kV	kV	kV	lb	in	in	in	lb	in	lb	lb	in-lb
1.7P-550	286	115	550	230	54	45	123	37	1.700	0.23	20.000	60.000	40.000
2.6P-550	287	115	550	230	61	45	123	37	2.600	0.28	25.000	75.000	90.000
5.2P-550	287	115	550	230	96	45	122	35	5.200	0.19	25.000	75.000	90.000
1.4P-650	288	138	650	275	64	54	158	46	1.400	0.33	20.000	60.000	40.000
2.2P-650	289	138	650	275	73	54	158	46	2.200	0.41	25.000	75.000	90.000
4.4P-650	289	138	650	275	110	54	151	44	4.400	0.27	25.000	75.000	90.000
1.2P-750	291	161	750	315	73	62	186	54	1.200	0.42	20.000	60.000	40.000
1.85P-750	295	161	750	315	83	62	186	54	1.850	0.52	25.000	75.000	90.000
3.7P-750	295	161	750	315	125	62	184	52	3.700	0.35	25.000	75.000	90.000
0.95P-900	304	230	900	385	94	80	255	72	950	0.72	20.000	60.000	40.000
1.45P-900	308	230	900	385	106	80	255	72	1.450	0.88	25.000	75.000	90.000
2.2P-900	308	230	900	385	136	80	254	71	2.200	0.70	25.000	75.000	90.000
3P-900	308	230	900	385	156	80	248	70	3.000	0.60	25.000	75.000	90.000
0.8P-1050	312	315	1050	455	107	92	297	84	800	0.92	20.000	60.000	40.000
1.25P-1050	316	315	1050	455	121	92	297	84	1.250	1.15	25.000	75.000	90.000
2.3P-1050	362	315	1050	455	177	92	290	82	2.300	0.70	40.000	100.000	120.000
1P-1300	324	345	1300	525	139	106	352	98	1.000	1.41	25.000	75.000	90.000
1.45P-1300	367	345	1300	525	153	106	346	97	1.450	1.36	20.000	60.000	40.000
2P-1300	368	345	1300	525	202	106	345	96	2.000	0.94	40.000	100.000	120.000
0.9P-1470	330	500	1470	590	159	122	408	114	900	1.94	25.000	75.000	90.000
1.17P-1470	371	500	1470	590	176	122	408	113	1.170	1.67	20.000	60.000	40.000
1.75P-1470	372	500	1470	590	230	122	402	112	1.750	1.25	40.000	100.000	120.000
0.9P-1550	n/a	500	1550	620	167	128	430	120	900	2.24	20.000	60.000	40.000
1.7P-1550	379	500	1550	620	240	128	423	118	1.700	1.40	20.000	60.000	40.000
2.4P-1550	379	500	1550	620	278	128	423	118	2.400	1.54	20.000	60.000	40.000
1.4P-1800	391	500	1800	710	283	152	513	142	1.400	1.93	20.000	60.000	40.000
2P-1800	391	500	1800	710	328	152	513	142	2.000	2.14	20.000	60.000	40.000
2.8P-1800	391	500	1800	710	391	152	506	140	2.800	1.65	20.000	60.000	40.000
1.2P-2050	n/a	800	2050	830	336	182	624	172	1.200	2.84	20.000	60.000	40.000
1.6P-2050	n/a	800	2050	830	390	182	624	172	1.600	2.95	20.000	60.000	40.000
2.2P-2050	n/a	800	2050	830	464	182	617	170	2.200	2.23	20.000	60.000	40.000
1.2P-2250	n/a	800	2250	n/a	360	196	674	186	1.200	3.55	20.000	60.000	40.000
1.6P-2250	n/a	800	2250	n/a	418	196	674	186	1.600	3.68	20.000	60.000	40.000
2.2P-2250	n/a	800	2250	n/a	497	196	667	184	2.200	2.79	20.000	60.000	40.000
1P-2400	n/a	800	2400	n/a	382	208	721	198	1.000	3.54	20.000	60.000	40.000
1.4P-2400	n/a	800	2400	n/a	444	208	721	198	1.400	3.85	20.000	60.000	40.000
2P-2400	n/a	800	2400	n/a	527	208	714	196	2.000	3.03	20.000	60.000	40.000
1P-2550	n/a	800	2550	n/a	476	224	778	214	1.000	3.43	20.000	60.000	40.000
1.4P-2550	n/a	800	2550	n/a	476	224	778	214	1.400	4.80	20.000	60.000	40.000
2P-2550	n/a	800	2550	n/a	565	224	771	212	2.000	3.78	20.000	60.000	40.000

Porcelain Station Post Insulators

PRODUCT SELECTION INFORMATION

Description	Strength	BIL (kV)	System Voltage (kV)	Overall Height (in)	Bolt Circle Diameter Top/Bottom (in)	Leakage Distance (in)	Cantilever Strength (lbs)
SP-TR202PG	STD	95	7.5	7.5	3	10.5	2000
SP-TR222PG	High	95	7.5	10	5	10.5	4000
SP-TR222PG01	Ex-High	95	7.5	10	5	10.5	8000
SP-TR205PG	STD	110	15	10	3	15.5	2000
SP-TR225PG	High	110	15	12	5	15.5	4000
SP-TR225PG01	Ex-High	110	15	12	5	15.5	8000
SP-TR208PG	STD	150	25	14	3	24	2000
SP-TR227PG	High	150	25	15	5	24	4000
SP-TR227PG01	Ex-High	150	25	15	5	24	8000
SP-TR210PG	STD	200	35	18	3	37	2000
SP-TR231PG	High	200	25	20	5	37	4000
SP-TR231PG01	Ex-High	200	25	20	5	37	8000
SP-TR214PG	STD	250	46	22	3	43	2000
SP-TR267PG	High	250	46	24	5	43	4000
SP-TR267PG01	Ex-High	250	46	25	7	43	8000
SP-TR216PG	STD	350	69	30	3	72	1500
SP-TR278PG	High	350	69	30	5	72	3000
SP-TR278PG01	Ex-High	350	69	32	7	72	6000
SP-TR286PG	STD	550	115	45	5	99	1700
SP-TR287PG	High	550	115	45	5	99	2600
SP-TR287PG01	Ex-High	550	115	45	7	99	5000
SP-TR288PB	STD	650	138	54	5	116	1400
SP-TR289PG	High	650	138	54	5	116	2200
SP-TR289PG01	Ex-High	650	138	54	5/7	116	4100
SP-TR291PG	STD	750	161	62	5	132	1200
SP-TR295PG	High	750	161	62	5	132	1850
SP-TR295PG01	Ex-High	750	161	62	7	132	3500
SP-TR304PG	STD	900	230	80	5	165	950
SP-TR308PG	High	900	230	80	5	165	1450
SP-TR312PG	STD	1050*	345	92	5	198	800
SP-TR316PG	High	1050*	345	92	5	198	1250
SP-TR362PG	Ex-High	1050*	345	92	7	198	2300
SP-TR324PG	STD	1300*	345	106	5	231	1000
SP-TR367PG	High	1300*	345	106	5/7	231	1450
SP-TR368PG	Ex-High	1300*	345	106	7	231	2000
SP-TR369PG	Ex-High	1300*	345	106	5/7	231	2050
SP-TR369PG02	Ex-High	1300*	345	106	5/7	231	3500
SP-TR330PG	STD	1470*	500	122	5	264	900
SP-TR371PG	High	1470*	500	122	5/7	264	1170
SP-TR373PG	Ex-High	1470*	500	122	5/7	264	1750
SP-TR372PG	Ex-High	1470*	500	122	7	264	1750
SP-TR379PG	Ex-High	1550*	500	128	7	280	1700
SP-TR391PG	STD	1800*	500	152	5/7	330	1400
SP-TR391PG02	High	1800*	500	152	5/7	360	1750
SP-TR391PG03	Ex-High	1800*	500	152	5/7	360	4000

*Note: Items available with optional corona ring





Chapter 6 TE's Raychem Cable Repair & Rejacketing

GMRS Rejacketing Sleeve	230
MBSM Wraparound Jacket Repair	231
HVS-LR Repair Kits	232
CRSM Wraparound Sleeves (1000 V)	233
MRS Wraparound Flame Retardant Sleeve	234



GMRS Rejacketing Sleeve

FEATURES

- Precoated with a thermoplastic sealant that provides an excellent seal against moisture and corrosive elements
- MSHA approved (No. P-137-13-MSHA)
- Seals and protects cable splices and cable jackets up to 35 kV
- Compact design and fast installation

APPLICATIONS

- TE's Raychem CRPS repair strip is a high-quality replacement jacket for low and high voltage flexible mining cables.
- For direct buried, underground, and overhead applications

BENEFITS

- ♦ Tool-free, flexible, flame-retardant elastomeric strip for jacket repair on mining and other flexible cable
- ♦ Unlimited shelf life when stored under normal conditions

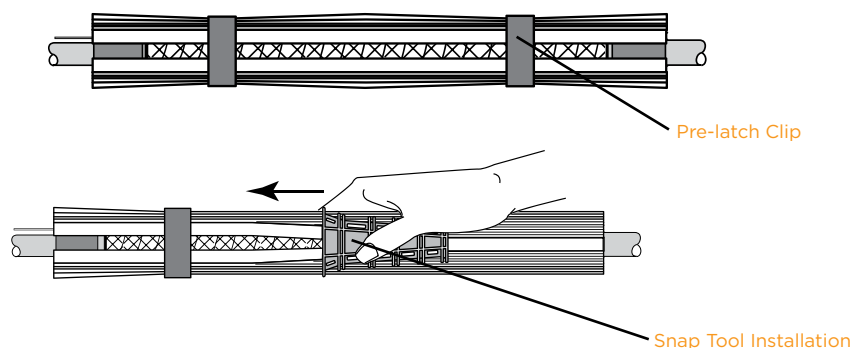
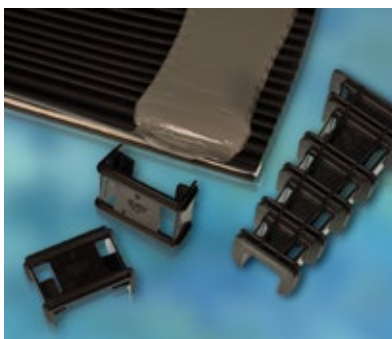

PRODUCT SELECTION INFORMATION: DIMENSIONS IN INCHES (MM)

Catalog Number	Sleeve Length	Cable Jacket O.D. (min)	Splice O.D. (max)	Max Jacket Opening
GMRS-75/25-650	25.5 (650)	1 (25)	2.5 (63)	17.5 (445)
GMRS-75/25-750	29.5 (750)	1 (25)	2.5 (63)	21.5 (545)
GMRS-75/25-850	33.5 (850)	1 (25)	2.5 (63)	25.5 (648)
GMRS-75/25-1050	41.25 (1050)	1 (25)	2.5 (63)	33.25 (820)
GMRS-75/25-1200	47.25 (1200)	1 (25)	2.5 (63)	39.25 (996)
GMRS-100/40-750	29.5 (750)	1.5 (38)	3.5 (89)	21.5 (545)
GMRS-100/40-850	33.5 (850)	1.5 (38)	3.5 (89)	25.5 (648)
GMRS-100/40-1050	41.25 (1050)	1.5 (38)	3.5 (89)	33.25 (820)
GMRS-100/40-1200	47.25 (1200)	1.5 (38)	3.5 (89)	39.25 (996)

ADDITIONAL PRODUCT INFORMATION

- Select the appropriate catalog number based on the cable diameter and the jacket opening. Cable and splice body must be within specified use range.
- Standard package: 3 kits per box. Each kit contains one strip of mastic and one solvent wipe. Each box of 3 kits contains one installation snap tool and 2 pre-latch clips.
- GMRS-75/25 and GMRS-100/40 meet the test requirements of IEEE 404-2006. Request EDR # 5507.

MBSM Wraparound Jacket Repair Sleeve

FEATURES

- Available in five diameters with 5:1 shrink ratios
- For use on standard poly- or elastomeric-insulated/jacketed cables, which may include aluminum or steel armoring and PILC

APPLICATIONS

- TE's Raychem MBSM protects cables in mechanically abusive environments; re-jacket premolded splices; repair and re-jacket LC-shielded and moisture impervious cables; and provide strain relief
- Seals and protects cables

BENEFITS

- Offers a fast, versatile and permanent repair for damaged cable jackets
- Unlimited shelf life when stored under normal temperatures
- Excellent moisture barrier
- Sleeve may be field-cut for shorter requirements.

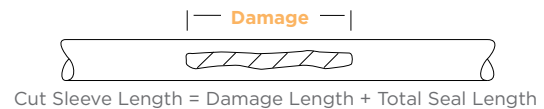
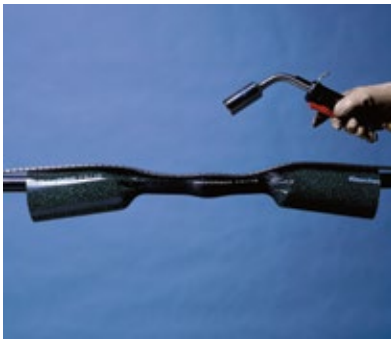

Damage	Total Seal Length
<3 (<76)	3 (76)
3-12 (76-305)	4 (102)
12-24 (305-610)	6 (152)
>24 (>610)	8 (203)

PRODUCT SELECTION INFORMATION: DIMENSIONS IN INCHES (MM)

Catalog Number	Cable Use Range (min - max)	Sleeve Length*	Standard Pack (kits/box)
MBSM-43/8-1200	0.35-1.50 (9-38)	48 (1219)	6
MBSM-75/15-1200	0.65-2.65 (17-67)	48 (1219)	6
MBSM-125/30-1200	1.30-4.30 (33-109)	48 (1219)	6
MBSM-160/42-1200	1.80-5.70 (46-145)	48 (1219)	6
MBSM-200/50-1200	2.15-7.10 (55-180)	48 (1219)	6

NOTICE: MBSM sleeves do not provide electrical insulation due to aluminum within the sleeve structure.

*Length tolerance is ± 2%.

ADDITIONAL PRODUCT INFORMATION

- Select appropriate catalog number based on the cable use range.
- Kits contain a wraparound sleeve, stainless steel channel closure, and redundant sealant strips.
- Related test report: EDR-5225, EDR-5270, and EDR-5388

HVS-LR Lead Sheath Repair Kits for PILC Cable

FEATURES

- See "Product Performance Test" chart below for featured parameters"

APPLICATIONS

- Repair lead sheath damage on paper-insulated, lead covered (PILC) cable

BENEFITS

- Combines the strength and durability of TE's Raychem MBSM wraparound sleeve with an effective oil-resistant sealing mastic

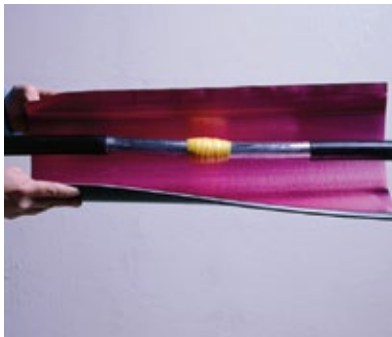

Product Performance Test

Current cycling at 110 °C conductor temperature for 90 cycles (5 hours on - 3 hours off)	PASS
Applied Pressure	15 psi
Maximum continuous conductor temperature	110 °C

PRODUCT SELECTION INFORMATION: DIMENSIONS IN INCHES (MM)

Catalog Number	Nominal Sleeve Length	Application Use Range (min - max)
HVS-LR-75/15-600	24 (600)	0.65-2.65 (17-67)
HVS-LR-75/15-1200	48 (1200)	0.65-2.65 (17-67)
HVS-LR-160/42-600	24 (600)	1.80-5.70 (46-144)
HVS-LR-160/42-1200	48 (1200)	1.80-5.70 (46-144)
HVS-LR-200/50-600	24 (600)	2.15-7.10 (55-180)
HVS-LR-200/50-1200	48 (1200)	2.15-7.10 (55-180)

ADDITIONAL PRODUCT INFORMATION

- Select the appropriate catalog number based on cable jacket diameter and the lead sheath diameter.
- Standard package: 3 kits/box.
- Related test report: EDR-5243.

CRSM Heat Shrink Wraparound Sleeves

FEATURES

- All TE's Raychem CRSM sleeves are sealant-coated.
- Qualified to ANSI C119.1
- Rated to ICEA electrical withstand test for 1000 volts
- RUS accepted for use as jacket restoration materials on JCN cable

APPLICATIONS

- For use on standard poly- or elastomeric insulated/jacketed cables or lead-jacketed cables, which may include aluminum or steel armoring.
- Use as insulation for 1/C low-voltage power cable up to 1000 volts, jacket repair up to 35 kV, or general sealing applications.

BENEFITS

- TE's Raychem CRSM sleeves close easily with a permanent locking system that consists of a raised rail profile and a stainless steel channel.
- Unlimited shelf life when stored under normal conditions
- Excellent water seal - tested in one foot head of water
- Length may be field-cut for versatility



PRODUCT SELECTION INFORMATION: DIMENSIONS IN INCHES (MM)

Primary Electrical Repair (1000 V)					
Catalog Number	Sleeve Length	Cable and Jacket Repair Conductor Size Use Range		General Sealing Use Range (0 - 35 kV) (min - max)	Standard Pack
		AWG/kcmil	min - max		
CRSM-34/10-200	8 (200)	#8-2/0	0.25-0.60 (6-15)	0.25-1.20 (6-30)	3
CRSM-34/10-1200	48 (1219)	#8-2/0	0.25-0.60 (6-15)	0.25-1.20 (6-30)	5
CRSM-53/13-200	8 (200)	3/0-400	0.60-0.95 (15-24)	0.60-1.80 (15-46)	10
CRSM-53/13-1200	48 (1219)	3/0-400	0.60-0.95 (15-24)	0.60-1.80 (15-46)	5
CRSM-84/20-750	30 (750)	500-1000	0.95-1.40 (24-36)	0.95-2.70 (24-69)	10
CRSM-84/20-1000	40 (1000)	500-1000	0.95-1.40 (24-36)	0.95-2.70 (24-69)	10
CRSM-84/20-1200	48 (1219)	500-1000	0.95-1.40 (24-36)	0.95-2.70 (24-69)	5
CRSM-107/29-1000	40 (1000)	1000-2000	1.30-2.00 (33-51)	1.30-3.60 (33-91)	10
CRSM-107/29-1200	48 (1219)	1000-2000	1.30-2.00 (33-51)	1.30-3.60 (33-91)	5
CRSM-143/36-1200	48 (1219)			1.65-4.95 (42-126)	5
CRSM-198/55-1200	48 (1219)			2.50-6.50 (64-165)	5

ADDITIONAL PRODUCT INFORMATION

- Select the appropriate catalog number for either primary electrical repair (1000 volts max.) or general sealing applications. Electrical repair selections are based on typical dimensions for low voltage insulated cable. Confirm selection with cable dimensions to assure proper sizing.
- Use the "primary electrical repair" columns for electrical repair applications (when CRSM is in direct contact with the conductor).
- Use the "General sealing use range" column for general rejacketing or sealing applications (when CRSM is not in direct contact with the conductor).
- Package does not contain connectors.
- Related Test Reports: EDR-5124, EDR-5192, and EDR-5388. UV resistant test report: EDR-5361.
- CRSM-34/10 and CRSM-84/20 are available in shorter standard lengths by ordering the corresponding CRSM-CT kits. (The use ranges in the selection information table still apply).



Cut Sleeve Length = Damage Length + Total Seal Length

Damage	Total Seal Length
<3 (<76)	3 (76)
3-12 (76-305)	4 (102)
12-24 (305-610)	6 (152)
>24 (>610)	8 (203)

MRS Heat Shrink Wraparound Flame-Retardant Repair Sleeve

FEATURES

- MSHA approved (P-07-KA090012-MSHA)
- Flame-Retardant
- Green thermosensitive paint provides visual guide for proper installation.
- Sleeve is precoated with adhesive.

APPLICATIONS

- TE's Raychem MRS Sleeve repairs insulation on flexible cables to 2 kV and repairing jacket damage on high-voltage cable where a splice is not required.
- Ideal for use on trailing cable as well as flexible-construction cables and conduits

BENEFITS

- ♦ Installs with a low profile quickly and easily, which means the cable can be returned to service in minutes.
- ♦ Length may be field-cut for versatility
- ♦ Excellent water barrier - tested under one foot of water
- ♦ Unlimited shelf life when stored under normal conditions



PRODUCT SELECTION INFORMATION: DIMENSIONS IN INCHES (MM)

Catalog Number	Cable Use Repair Sleeve (min - max)	Sleeve Length	Standard Pack (kits/box)
MRS-12-10	1.00-1.60 (25-41)	10 (254)	20
MRS-12-24	1.00-1.60 (25-41)	24 (610)	10
MRS-34-24	1.60-2.30 (41-58)	24 (610)	10
MRS-34-30	1.60-2.30 (41-58)	30 (762)	10
MRS-56-30	2.30-3.50 (58-89)	30 (762)	10

ADDITIONAL PRODUCT INFORMATION

- Select the appropriate catalog number based on cable diameter.
- Kits do not contain connectors.
- Kits contain a wraparound sleeve and stainless steel channel closure (removed after installation).
- Related test report: EDR-5028 and EDR-5499.

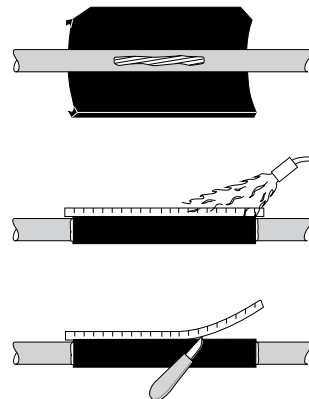
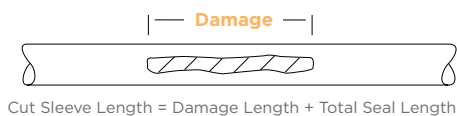

Damage	Total Seal Length
<3 (<76)	3 (76)
3-12 (76-305)	4 (102)
12-24 (305-610)	6 (152)
>24 (>610)	8 (203)

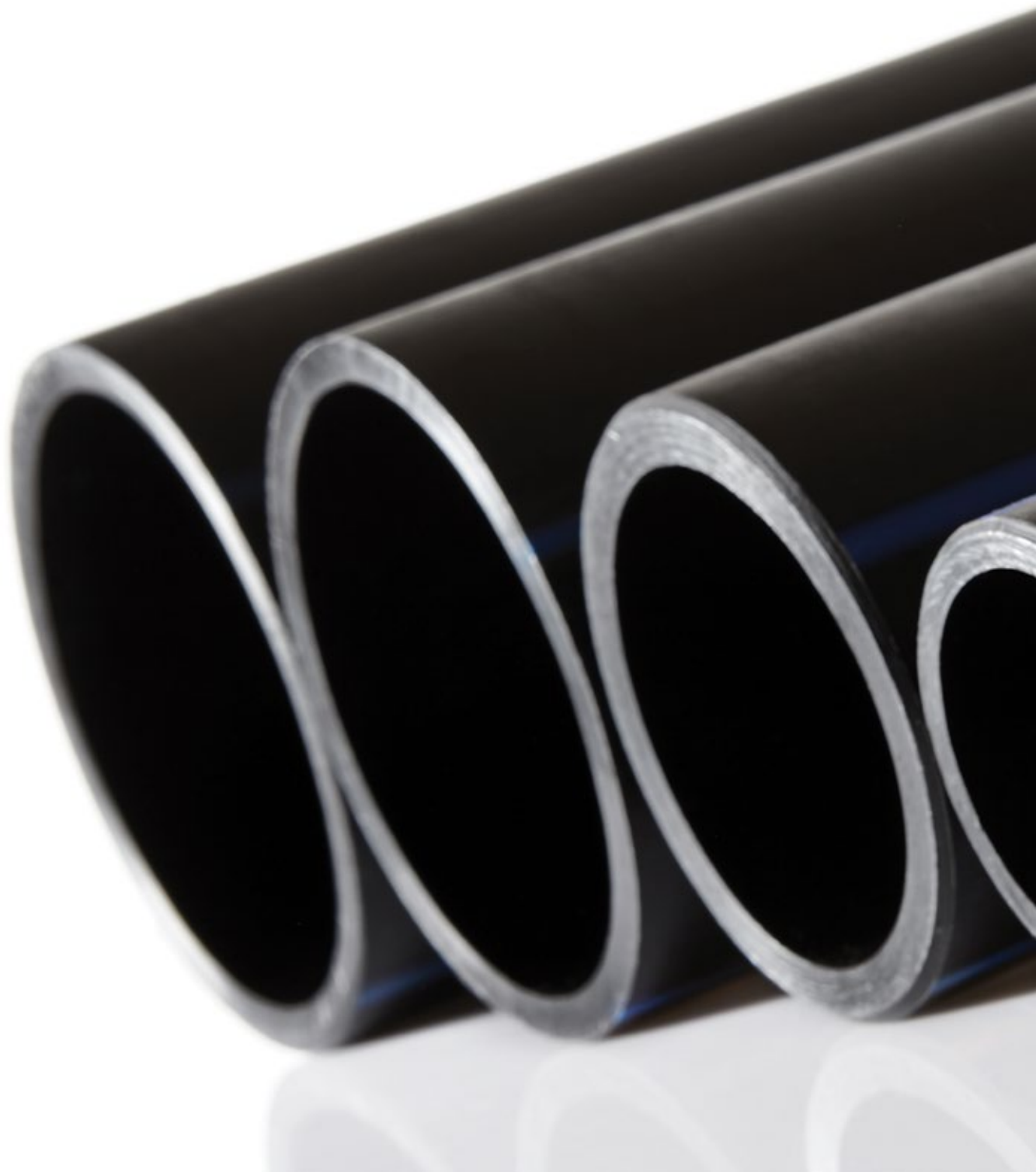

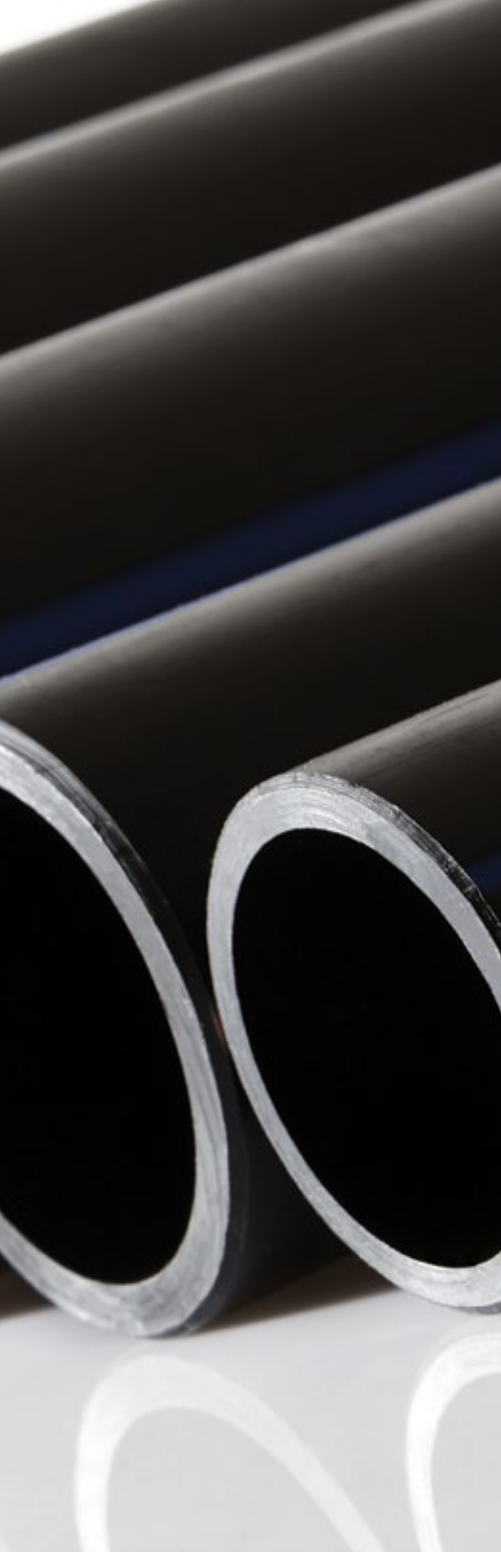

Chapter 7 TE's Raychem Tubing & Molded Parts

Heat Shrink Tubing	238
Molded Parts	243

RNF-100 Thin-Wall, Uncoated Tubing

FEATURES

- UL recognized to standard 224 (file E35586)
- Flame retardant (colors only)
- Black, white, and colors meet AMS-DTL-23053/5, Class 1. Clear meets AMS-DTL-23053/5, Class 2
- 2:1 shrink ratio
- Unlimited shelf life when stored under normal conditions

APPLICATIONS

- TE's Raychem RNF-100 is a flexible, flame-retardant, thin-wall, general purpose heat-shrinkable polyolefin tubing ideal for wire jacketing marking and color coding

BENEFITS

- ♦ Superior abrasion and solvent resistance when compared to other flexible general purpose polyolefin tubings
- ♦ Excellent physical, chemicals, and electrical properties that meet or exceed industrial and military standards.



UL recognized to Standard 224
600V/125°C

PRODUCT SELECTION INFORMATION: DIMENSIONS IN INCHES (MM)

Catalog Number	Inner Diameter as Supplied	Recovered	Recovered Wall Thickness (mils)	Color*	Feet/Spool
RNF-100-1/16-25-(color)	.063 (1.6)	.031 (0.8)	17	BLK, WHT, CL	25
RNF-100-3/32-25-(color)	.093 (2.4)	.046 (1.2)	20	BLK, WHT, CL	25
RNF-100-1/8-25-(color)	.125 (3.2)	.062 (1.6)	20	BLK, WHT, CL	25
RNF-100-1/8-500-(color)	.125 (3.2)	.062 (1.6)	20	BLK, WHT, RED	500
RNF-100-3/16-25-(color)	.187 (4.8)	.093 (2.4)	20	BLK, WHT, CL	25
RNF-100-1/4-25-(color)	.250 (6.4)	.125 (3.2)	25	BLK, WHT, CL	25
RNF-100-1/4-250-(color)	.250 (6.4)	.125 (3.2)	25	BLK, WHT, RED	250
RNF-100-3/8-25-(color)	.375 (9.6)	.187 (4.8)	25	BLK, WHT, CL	25
RNF-100-3/8-200-(color)	.375 (9.6)	.187 (4.8)	25	BLK, WHT, RED, GRN, BLUE	200
RNF-100-1/2-25-(color)	.500 (13)	.250 (6.4)	25	BLK, WHT, CL	25
RNF-100-1/2-150-(color)	.500 (13)	.250 (6.4)	25	BLK, WHT, RED, GRN, BLUE	150
RNF-100-3/4-25-(color)	.750 (19)	.375 (9.6)	30	BLK, WHT, CL	25
RNF-100-1-25-(color)	1.000 (25)	.500 (13)	35	BLK, WHT, CL	25
RNF-100-1-1/2-25-(color)	1.500 (38)	.750 (19)	40	BLK, WHT, CL	25
RNF-100-2-25-(color)	2.000 (51)	1.00 (25)	45	BLK, WHT, CL	25

Order spools as RNF-100-Size-Spool Length-color

Other sizes, colors, and packaging are available

* BLK=Black, WHT=White, CL=Clear, GRN=Green

MWTM Medium-Wall Sealant-Coated or Uncoated Tubing

FEATURES

- RUS accepted as jacket restoration of JCN cable
- 3:1 shrink ratio

APPLICATIONS

- TE's Raychem Sealant-coated MWTM tubing (-S designation) is for use as insulation/jacket repair up to 600 V or for general sealing and re-jacketing of polymeric- or elastomeric-insulated cables up to 35 kV
- Uncoated MWTM tubing (-U or -A/U) is for cable re-jacketing only

BENEFITS

- ♦ Designed to Match Cable Performance
- ♦ Range Taking
- ♦ Conforms to Substrate
- ♦ Quick Installation
- ♦ Unlimited shelf life when stored in normal conditions
- ♦ Cut to Length at Job Site



PRODUCT SELECTION INFORMATION: DIMENSIONS IN INCHES (MM)

Catalog Number	Use Range (min - max)	Cut-Piece Length	Min. Cont. Length Ft (m)	Standard Package Quantity		
				Box	Spool Ft (m)	Bulk Spool Ft (m)
Sealant-Coated, Cut-Length Tubing						
MWTM-10/3-1200-S	0.13-0.35 (3-9)	48 (1200)		25		
MWTM-16/5-1200-S	0.25-0.55 (6-14)	48 (1200)		25		
MWTM-25/8-1200-S	0.35-0.85 (9-22)	48 (1200)		25		
MWTM-35/12-1200-S	0.50-1.25 (13-32)	48 (1200)		25		
MWTM-50/16-1200-S	0.65-1.70 (17-43)	48 (1200)		15		
MWTM-85/25-1200-S	1.00-2.90 (25-74)	48 (1200)		5		
MWTM-115/34-1200-S	1.40-3.90 (36-99)	48 (1200)		5		
MWTM-140/42-1200-S	1.80-4.70 (46-119)	48 (1200)		5		
Uncoated, Spooled Tubing						
MWTM-10/3-A/U	0.13-0.35 (3-9)		25 (7.6)		100 (30)	
MWTM-16/5-A/U	0.25-0.55 (6-14)		25 (7.6)		100 (30)	1155 (350)
MWTM-25/8-A/U	0.35-0.85 (9-22)		25 (7.6)		100 (30)	660 (200)
MWTM-35/12-A/U	0.50-1.25 (13-32)		25 (7.6)		100 (30)	495 (150)
MWTM-50/16-A/U	0.65-1.70 (17-43)		15 (4.6)		75 (23)	330 (100)
Uncoated, Cut Length Tubing						
MWTM-85/25-1500/U	1.00-2.90 (25-74)	60 (1500)		5		
MWTM-115/34-1500/U	1.40-3.90 (36-99)	60 (1500)		5		
MWTM-140/42-1500/U	1.80-4.70 (46-119)	60 (1500)		5		

For connector information refer to the Connectors and Terminals section of this catalog.

ADDITIONAL PRODUCT INFORMATION

- Select the appropriate catalog number. Confirm selection with application dimensions to assure proper sizing.
- MWTM is a general purpose tubing; for sealing applications use MWTM with sealant (-S) or use uncoated MWTM (-U or -A/U) in combination with S1052 sealant. Order sealants separately.
- For testing information refer to the Technical Data section of this catalog.
- UV resistant test report: EDR-5361.

WCSM Heavy-Wall Sealant Coated Tubing

FEATURES

- 4:1 shrink ratio
- UL and cUL listed per 486D (file E91151) for sizes 12/3 through 70/20.
- Qualified to ANSI C119.1 and rated to Western Underground guide 2.5.
- RUS accepted for use as a secondary tap or splice cover, and for use as jacket restoration materials on JCN cable.

APPLICATIONS

- TE's Raychem WCSM tubing seals an in-line splice or terminal lug seal for non-flame retardant applications, cable re-jacketing and mechanical protection.
- Jacket repair on cables up to 35 kV.
- For use on standard poly or elastomeric insulated / jacketed cable or lead-jacketed cables, which may include aluminum or steel armoring.
- Can be used for electrical insulation of cables up to 1000V

BENEFITS

- ♦ Designed to Match Cable Performance
- ♦ Range Taking
- ♦ Conforms to Substrate
- ♦ Smallest Installed Profile
- ♦ Quick Installation
- ♦ Unlimited Shelf Life
- ♦ Cut to Length at Job Site



Wire Connector System for use with Underground Connectors 96J4

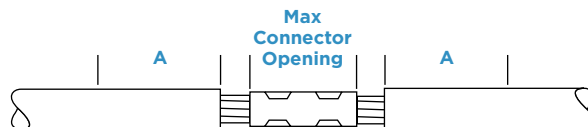

PRODUCT SELECTION INFORMATION: DIMENSIONS IN INCHES (MM)

Catalog Number	1000V Cable Nominal Use Range AWG/kcmil (min-max)	Maximum Connector O.D.	UL Conductor Use Range (min-max)	General Conductor Use Range (min-max)	Max Connector Opening	Min Seal Length per Side (A)
WCSM-12/3-150-S	#14-#6	0.29	.13-.30 (3.5-7.7)	.13-.39 (3.5-10)	2.9	1.5
WCSM-12/3-300-S	#14-#6	0.29	.13-.30 (3.5-7.7)	.13-.39 (3.5-10)	8.8	1.5
WCSM-12/3-1200-S	#14-#6	0.29	.13-.30 (3.5-7.7)	.13-.39 (3.5-10)	44.2	1.5
WCSM-16/4-150-S	#8-#2	0.41	.17-.41 (4.5-10.5)	.17-.55 (4.5-14)	1.9	2
WCSM-16/4-300-S	#8-#2	0.41	.17-.41 (4.5-10.5)	.17-.55 (4.5-14)	7.8	2
WCSM-16/4-1200-S	#8-#2	0.41	.17-.41 (4.5-10.5)	.17-.55 (4.5-14)	43.2	2
WCSM-24/6-150-S	#6-#4/0	0.69	.25-.64 (6.5-16.5)	.25-.86 (6.5-22)	1.4	2
WCSM-24/6-225-S	#6-#4/0	0.69	.25-.64 (6.5-16.5)	.25-.86 (6.5-22)	3.96	2
WCSM-24/6-300-S	#6-#4/0	0.69	.25-.64 (6.5-16.5)	.25-.86 (6.5-22)	6.8	2
WCSM-24/6-1200-S	#6-#4/0	0.69	.25-.64 (6.5-16.5)	.25-.86 (6.5-22)	38.3	2
WCSM-34/8-150-S	#2-500	1.06	.35-.94 (9-24)	.35-1.22 (9-31)	1.4	2
WCSM-34/8-200-S	#2-500	1.06	.35-.94 (9-24)	.35-1.22 (9-31)	3.02	2
WCSM-34/8-225-S	#2-500	1.06	.35-.94 (9-24)	.35-1.22 (9-31)	3.96	2
WCSM-34/8-300-S	#2-500	1.06	.35-.94 (9-24)	.35-1.22 (9-31)	6.8	2
WCSM-34/8-1200-S	#2-500	1.06	.35-.94 (9-24)	.35-1.22 (9-31)	38.48	2
WCSM-48/12-150-S	#2/0-750	1.3	.51-1.12 (13-28.5)	.51-1.73 (13-44)	1.4	2
WCSM-48/12-225-S	#2/0-750	1.3	.51-1.12 (13-28.5)	.51-1.73 (13-44)	3.96	2
WCSM-48/12-300-S	#2/0-750	1.3	.51-1.12 (13-28.5)	.51-1.73 (13-44)	6.8	2
WCSM-48/12-1200-S	#2/0-750	1.3	.51-1.12 (13-28.5)	.51-1.73 (13-44)	38.3	2
WCSM-56/16-225-S	250-1000	1.5	.68-1.27 (17.5-32.5)	.70-1.96 (17.5-50)	3.96	2
WCSM-56/16-300-S	250-1000	1.5	.68-1.27 (17.5-32.5)	.70-1.96 (17.5-50)	6.62	2
WCSM-56/16-1200-S	250-1000	1.5	.68-1.27 (17.5-32.5)	.70-1.96 (17.5-50)	38.3	2
WCSM-70/20-300-S	500-1500	1.84	.92-1.40 (22-35.8)	.86-2.48 (22-63)	5.8	2.5
WCSM-70/20-450-S	500-1500	1.84	.92-1.40 (22-35.8)	.86-2.48 (22-63)	10.93	2.5
WCSM-70/20-600-S	500-1500	1.84	.92-1.40 (22-35.8)	.86-2.48 (22-63)	16.26	2.5
WCSM-70/20-1200-S	500-1500	1.84	.92-1.40 (22-35.8)	.86-2.48 (22-63)	37.3	2.5
WCSM-110/30-300-S	800-2000	-	-	1.29-3.93 (33-100)		2.5
WCSM-110/30-1200-S	800-2000	-	-	1.29-3.93 (33-100)		2.5
WCSM-130/35-300-S	1500-2500	-	-	1.49-4.64 (39-118)		2.5
WCSM-130/35-450-S	1500-2500	-	-	1.49-4.64 (39-118)		2.5
WCSM-130/35-1200-S	1500-2500	-	-	1.49-4.64 (39-118)		2.5

ADDITIONAL PRODUCT INFORMATION

- Select the appropriate catalog number based on typical dimensions for low-voltage insulated cable. Confirm selection with dimensions to assure proper sizing. For general conductor use or UL conductor use.
- Package does not contain connectors or lugs. Installed connector or lug diameter must be within use range.
- TE's Raychem WCSM tubing may be field-cut for shorter requirements
- Bulk packaging is available for cut lengths. Consult your TE representative for more information.
- UL listing applies to WCSM-12/3 through -70/20 only. WCSM-110/30 and -130/35 are not UL listed.
- Related test reports: EDR 5541, UL 486D test report: EDR 5139, UV resistant test report: EDR-5361

For connector information refer to the Connectors and Terminals section of this catalog.



Heat Shrink Wraparound FCSM Tubing

FEATURES

- Flame retardant
- 3:1 shrink ratio
- Qualified to ANSI C119.1 also rated to IEEE 383 (Vertical Tray Flame Test) and ICEA S-19-81.
- MSHA approved (No. 07-KA090013-MSHA).

APPLICATIONS

- Use sealant-coated tubing (-S) as a sealed in-line splice or terminal lug seal.
- Use uncoated tubing (-/U) for cable rejacketing only
- TE's Raychem FCSM sealant-coated or uncoated tubing may be used for jacket repair on cable to 35 kV
- Used for electrical insulation of cables up to 2000V

BENEFITS

- ♦ Designed to match cable performance
- ♦ Range taking
- ♦ Conforms to substrate
- ♦ Quick installation
- ♦ Unlimited shelf life when stored in normal conditions
- ♦ Cut to length at job site



Connectors up to 6 inches:	Connectors over 6 inches:
Recommended cut length = connector length + 4 inches.	Recommended cut length = connector length + 5 inches.

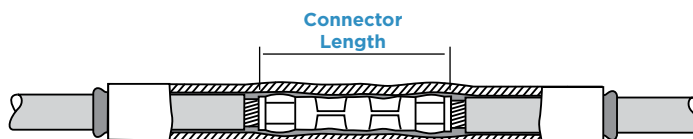

PRODUCT SELECTION INFORMATION: DIMENSIONS IN INCHES (MM)

Catalog Number	2000 V Insulated Conductor Size (AWG/kcmil)	General Use Range (min - max)	Tube Length*	Standard Package		
				Ft. (m)/Roll	Pcs/Box	Ft. (m)/Roll
In-Line Splice Or Terminal Lug Seal (With Sealant)						
FCSM-9/3-1200-S	#14-#8	0.15-0.30 (4-8)	48 (1200)		25	
FCSM-19/6-150-S	#6-#2	0.25-0.65 (6-17)	6 (150)		50	
FCSM-19/6-1200-S	#6-#2	0.25-0.65 (6-17)	48 (1200)		25	
FCSM-28/9-225-S	#2-4/0	0.40-0.95 (10-24)	9 (225)		50	
FCSM-28/9-1200-S	#2-4/0	0.40-0.95 (10-24)	48 (1200)		25	
FCSM-38/12-300-S	1/0-350	0.50-1.30 (13-33)	12 (300)		40	
FCSM-38/12-1200-S	1/0-350	0.50-1.30 (13-33)	48 (1200)		10	
FCSM-51/16-300-S	250-500	0.70-1.75 (18-44)	12 (300)		30	
FCSM-51/16-1200-S	250-500	0.70-1.75 (18-44)	48 (1200)		10	
FCSM-68/22-1200-S	600-1000	0.95-2.30 (25-58)	48 (1200)		10	
FCSM-90/30-1200-S	800-1200	1.30-3.10 (33-79)	48 (1200)		5	
FCSM-120/40-1200-S	1500-2500	1.75-4.10 (44-104)	48 (1200)		5	
FCSM-177/63 600-S		2.75-6.05 (70-154)	24 (600)		6	
FCSM-177/63-1200-S		2.75-6.05 (70-154)	48 (1200)		5	
Cable Rejacketing (Without Sealant)						
FCSM-9/3-A/U	#14-#8	0.15-0.30 (4-8)		100 (30)		
FCSM-19/6-A/U	#6-#2	0.25-0.65 (6-17)		100 (30)		825 (250)
FCSM-28/9-A/U	#2-4/0	0.40-0.95 (10-24)		65 (20)		495 (150)
FCSM-38/12-A/U	1/0-350	0.50-1.30 (13-33)		50 (15)		395 (120)
FCSM-51/16-A/U	250-500	0.70-1.75 (18-44)		40 (12)		330 (100)
FCSM-68/22-A/U	600-1000	0.95-2.30 (25-58)		80 (24)		
FCSM-90/30-1500/U	800-1200	1.30-3.10 (33-79)	60 (1500)		5	
FCSM-120/40-1500/U	1500-2500	1.75-4.10 (44-104)	60 (1500)		5	
FCSM-177/63-1500/U		2.75-6.05 (70-154)	60 (1500)		5	

*Length tolerance to +/- 2%.

ADDITIONAL PRODUCT INFORMATION

- Select the appropriate catalog number based on typical dimensions for low-voltage insulated cable. Confirm selection with cable dimensions to assure proper sizing.
- Connectors or lugs not included. For connector information refer to the Connectors and Terminals section of this catalog.
- If sealant is needed with uncoated FCSM tubing (-/U), order S1052 separately.
- Tubing may be field-cut for shorter requirements.
- Bulk packaging is available for cut-lengths. Contact your TE representative for additional information.
- Related test reports: EDR-5133, EDR-5134, EDR-5141, EDR-5499.

LVIT Busbar Insulating Tubing (1000 V)

FEATURES

- Rated to ANSI/IEEE C37.20.1. UL recognized to Standard 224 (file E137416), 600 V-125°C-VW.1.

APPLICATIONS

- When used according to the selection guidelines, TE's Raychem LVIT may be used in applications up to 1 kV in accordance with ANSI/IEEE C37.20 specification. LVIT tubing may be used in applications up to 3.6 kV in accordance with IEC specifications.

BENEFITS

- TE's Raychem LVIT is a heat-shrinkable medium-wall, flame-retardant, low voltage tubing for insulating straight and bent busbars during original equipment assembly or in retrofit applications where access to one end of the busbar is available.



PRODUCT SELECTION INFORMATION: DIMENSIONS IN INCHES (MM)

Catalog Number	Rectangular Bar* (Bus Width)	Square Bar (Each Side)	Round Bar (Dia min - max)	LVIT Tubing Dia as Supplied & Fully Recovered (min - max)	Standard Pack
LVIT-30/10-A/U	0.50-1.0 (12-25)		0.40-1.0 (11-25)	1.18-0.39 (30-10)	200 ft.
LVIT-75/25-A/U	2.0-3.0 (50-75)	1 (25)	1.0-2.0 (25-50)	2.95-0.98 (75-25)	100 ft.
LVIT-150/50-A/U	4.0-6.0 (100-150)	2-3 (50-75)	2.0-4.0 (50-100)	5.91-1.97 (150-50)	100 ft.

*Rectangular bus thickness range is 1/4 to 5/8 inch. Test Reports: EDR-5483, EDR-5499

Raychem ESC End Sealing Caps

FEATURES

- Qualified to ANSI C119.1 and rated to ICEA electrical withstand test for 1000 volts
- TE's Raychem ESC end sealing caps are coated with a heat-activated sealant

APPLICATIONS

- Use as a live end seal to 1000 volts or as an end seal to prevent moisture ingress and contamination during storage and pulling of de-energized cable.

BENEFITS

- Fits easily over the cable end and shrinks in seconds forming a robust environmental seal
- Reduces cable failure and scrap
- Unlimited shelf life when stored in normal conditions

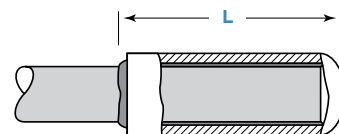

PRODUCT SELECTION INFORMATION: DIMENSIONS IN INCHES (MM)

Catalog Number	Primary Insulation Conductor Size (AWG/kcmil)	1000 V Use Range (min - max)	General Use Range (min - max)	Length (L)	Standard Pack* (Pcs./Box)
ESC-1/A	#12-#8	0.17-0.35 (4-9)	0.15-0.30 (4-8)	1	50
ESC-2/A	#6-3/0	0.31-0.71 (8-18)	0.30-0.70 (8-18)	2	50
ESC-3/A	4/0-750	0.65-1.25 (17-32)	0.65-1.25 (17-32)	3.5	40
ESC-4/A	750-1500	1.08-1.94 (27-49)	1.05-1.95 (27-50)	5.3	20
ESC-5/A	1500-2000	1.38-2.58 (35-66)	1.30-2.65 (33-67)	6.7	10
ESC-6/A		1.94-3.54 (49-90)	1.85-3.70 (47-94)	5.6	10
ESC-7/A		3.02-4.25 (77-108)	2.95-4.50 (75-114)	5.4	10

*Bulk options also available. Consult your TE Connectivity representative for information.

ADDITIONAL PRODUCT INFORMATION

- Select the appropriate catalog number based on the conductor size or use range. Confirm selection with dimensions to assure proper sizing.
- Each energized conductor requires a separate ESC sealing cap.
- Related test report: EDR-5161.

CFTS Heat Shrink Cabinet Feed-Through Seals

FEATURES

- Precoated with a thermoplastic adhesive that seals around the entering cable.
- Included O-ring creates the water/air seal at the cabinet entry.

APPLICATIONS

- TE's Raychem CFTS seals are heat shrinkable molded parts for moisture-sealing applications where cable enters enclosures, such as cabinets or connection boxes.

BENEFITS

- ♦ Utilizes a rigid plastic that, when inserted through the cabinet wall, protects the entering cable from abrasion or cut-through.

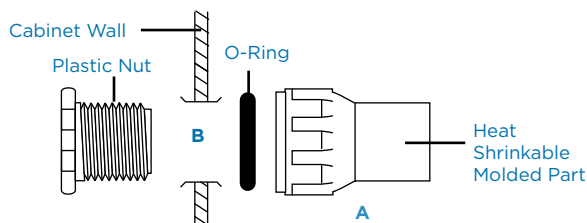

PRODUCT SELECTION INFORMATION: DIMENSIONS IN INCHES (MM)

Catalog Number	Cable Diameter (min - max)	Length of Molded Part (A)	Clearance (Knockout) Hole Size (B)	Standard Pack*
CFTS-1	0.20-0.40 (5-10)	2.75 (70)	1 (25)	5
CFTS-2	0.25-0.65 (6-17)	2.75 (70)	1 (25)	5
CFTS-3	0.55-1.00 (14-25)	3.75 (95)	1.375 (35)	5
CFTS-4	0.80-1.45 (20-37)	4.50 (114)	2 (51)	5
CFTS-5	1.45-2.40 (37-61)	7.00 (178)	3.5(89)	5

*Bulk options also available

CBR Heat Shrink Cable Breakout Boot

FEATURES

- 2, 3, 4, and 6 phase/ground leg configurations
- Seals are made of tough, crosslinked polyolefin to provide mechanical protection and strain relief.
- CBR seals are internally coated with heat-activated sealant.

APPLICATIONS

- TE's Raychem CBR products seal breakouts in multiconductor cables and conduit.
- For use on standard poly- or elastomeric insulated/jacketed multiconductor cables or cables in metal or plastic conduits.

BENEFITS

- ♦ Fast, easy, repeatable installation
- ♦ Unlimited shelf life when stored in normal conditions
- ♦ Sealant provides a durable, watertight seal
- ♦ Conforms tightly to conduits and cable jackets after shrinking



PRODUCT SELECTION INFORMATION: DIMENSIONS IN INCHES (MM)

Catalog Number	Cross Section	Body Use Range (min - max)	Legs Use Range (min - max)	Standard Pack
CBR-2-1-A		0.35-1.00 (9-25)	0.15-0.55 (4-14)	3
CBR-2-2-A*		1.25-1.70 (32-43)	0.30-0.75 (8-19)	3
CBR-2-3-A		1.65-3.00 (42-76)	0.65-1.40 (17-36)	3
CBR-3-1-A		0.50-1.35 (13-34)	0.20-0.55 (5-14)	3
CBR-3-2-A*		0.85-2.20 (22-56)	0.35-0.90 (9-23)	3
CBR-3-3-A*		1.10-2.90 (28-74)	0.50-1.25 (13-32)	3
CBR-3-4-A		2.35-5.65 (60-144)	1.20-2.10 (30-53)	3
CBR-4-1-A		0.70-1.25 (18-32)	0.15-0.45 (4-11)	3
CBR-4-2-A*		1.00-2.10 (25-53)	0.35-0.90 (9-23)	3
CBR-4-3-A*		1.20-3.50 (30-89)	0.55-1.40 (14-36)	3
CBR-4-4-A		2.35-6.05 (60-154)	0.90-1.90 (23-49) phase	3
			0.75-1.50 (19-39) ground	
CBR-6-1-A*		1.45-3.85 (37-98)	0.60-1.50 (15-38) phase	3
			0.30-0.75* (8-19) ground	
CBR-6-2-A*			2.65-5.30 (67-135)	0.90-2.20 (23-56) phase
		0.40-0.95* (10-24) ground	6	

CBR-Plugs (.64" diameter) are for blocking and sealing unused legs of breakouts. The plug will fit those items asterisked () above.





Chapter 8 TE's Raychem Tapes & Sealants

Tapes	248
Sealants	252

CRPS Flexible Cable Repair Tape

FEATURES

- Precoated with a thermoplastic sealant that provides an excellent seal against moisture and corrosive elements
- MSHA approved (No. P-137-13-MSHA)

APPLICATIONS

- TE's Raychem CRPS repair strip is a high-quality replacement jacket for low and high voltage flexible mining cables.

BENEFITS

- ♦ Tool-free, flexible, flame-retardant elastomeric strip for jacket repair on mining and other flexible cable.



Recommended coverage area includes 3 inches on either side of damaged area.

PRODUCT INFORMATION: DIMENSIONS IN INCHES (MM)

Catalog Number	Strip Length	Strip Width	Standard Pack (Strips/Box)
CRPS-248	48 (1219)	2 (51)	20
CRPS-260	60 (1524)	2 (51)	20
CRPS-290	90 (2286)	2 (51)	15
CRPS-2120	120 (3048)	2 (51)	10

APPROXIMATE COVERAGE LENGTH

Cable Diameter	CRPS-248	CRPS-260	CRPS-290	CRPS-2120
0.50 (13)	28 (711)	36 (914)	55 (1397)	73 (1854)
0.75 (19)	18 (457)	23 (584)	37 (940)	49 (1245)
1.00 (25)	14 (356)	17 (432)	26 (660)	35 (889)
1.25 (32)	11 (279)	14 (355)	21 (533)	28 (711)
1.50 (38)	9 (229)	11 (279)	18 (457)	24 (610)
1.75 (44)	7 (178)	9 (228)	15 (381)	20 (508)
2.00 (51)		8 (203)	14 (356)	19 (483)
2.50 (64)			10 (254)	13 (330)
3.00 (76)			9 (229)	12 (305)

ADDITIONAL PRODUCT INFORMATION

- Select the appropriate catalog number based on cable diameter and length of cable damage to be covered (see "Approximate coverage length" chart above). For larger damaged areas, multiple strips may be used to provide continuous coverage.
- To install, half-lap CRPS repair strip on cable, beginning 3 inches before damage and continuing 3 inches after damage.
- Related test report: EDR-5068.

FSTW Fast Splicing Tape Wrap

8

FEATURES

- Splices made with FSTW qualify to ANSI C119.1
- FSTW rubber tape is 50 mils thick, which offers strong puncture resistance from underground material and debris. FSTW is rated for use on 90°C rated cables, in underground use, in acid or caustic soils, and saltwater environments. It is UV resistant and rated for aerial exposure.



APPLICATIONS

- TE's Raychem FSTW is ideal for repairing cable jackets, sealing low-voltage splices, and re-jacketing MV cable splices.

BENEFITS

- FSTW tape provides a complete re-jacketing solution in one pass as opposed to the multi-layer construction required when using traditional tape products. It's quick to install. There is no need for separate sealing mastic and tape as it combines sealant and rubber tape in one convenient product.

PRODUCT INFORMATION: DIMENSIONS IN INCHES (MM)

Catalog Number	Roll Width	Roll Length Ft. (m)	Standard Pack
FSTW-2-1-6	2 (50)	6 (1.8)	12

APPROXIMATE COVERAGE LENGTH

Cable Diameter	FSTW-2-1-6
0.50 (13)	42 (1000)
0.75 (19)	27 (680)
1.00 (25)	21 (530)
1.25 (32)	17 (430)
1.50 (38)	14 (355)
1.75 (44)	10 (280)
2.00 (51)	9 (230)
2.50 (63)	7 (180)
3.00 (76)	6 (150)

ADDITIONAL PRODUCT INFORMATION

- See the approximate coverage length per roll based on cable diameter.
- For repairing cable jackets, install the FSTW tape beginning 2 inches before the damage and continuing 1 inch after.
- Related test reports: EDR-5431.

MVFT Medium Voltage Fusion Tape

FEATURES

- Exhibits non-tracking properties and possesses a continuous operating temperature up to 90 °C.
- A single layer of TE's Raychem MVFT tape, two-thirds overlapped, will provide AC voltage withstand (flashover protection) to at least 15 kV increasing to 35 kV if a second layer is applied.

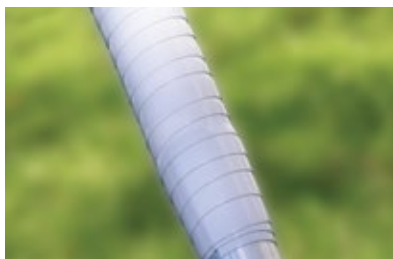

APPLICATIONS

- Fits easily over a wide variety of shapes and complex connections
- Simple and effective solution to the retrofitting of busbars where existing equipment cannot be dismantled

BENEFITS

- Indoor and outdoor versatility.
- Tool free installation
- Sticks to itself and insulation material - not metal or porcelain allowing for easy removal
- Quick and easy to install

PRODUCT INFORMATION

Catalog Number	Color	Width In (mm)	Length Ft. (m)	Standard Pack
MVFT-G-2-12(B4)	Gray	2 (50)	36 (11)	4 Rolls

Notes:

See HVBT for Heat applied alternative
Related Test Report: EDR-5465

LVBT Low Voltage Busbar Insulating Heat Shrink Tape

FEATURES

- Rated to ANSI/IEEE C37.20

APPLICATIONS

- TE's Raychem LVBT is an adhesive-coated, low-voltage heat-shrinkable tape. One wrap insulates straight and bent bars in retrofit applications where tubing cannot be used. In addition, LVBT easily insulates unusual connections and geometries in the factory or field.

BENEFITS

- Adhesive layer fuses the tape layers but does not stick to bus or hardware, providing tough insulation up to 1 kV in accordance with ANSI C37.20 and up to 3.6 kV in accordance with IEC specifications



LVBT TAPE DIMENSIONS

Catalog Number	Roll width in (mm)	Roll Length Ft. (m)
LVBT-1-R	1 (25)	25 (7.5)
LVBT-2-R	2 (50)	25 (7.5)
LVBT-4-R	4 (100)	25 (7.5)

PRODUCT SELECTION INFORMATION: DIMENSIONS IN FEET(M)

Bus Width	Catalog Number	Bus Length Insulated per Roll	Rolls/Standard Pack
-----------	----------------	-------------------------------	---------------------



Rectangular Busbar*

1 (25)	LVBT-1-R	3.8 (1.2)	8
2 (50)	LVBT-2-R	4.8 (1.5)	4
3 (75)	LVBT-2-R	3.5 (1.1)	4
4 (100)	LVBT-2-R	2.7 (0.8)	4
6 (150)	LVBT-2-R	1.9 (0.6)	4
8 (200)	LVBT-4-R	2.9 (0.9)	4

*Maximum thickness: 5/8 (15)



Square Busbar

1 (25)	LVBT-2-R	6.25 (2.0)	4
2 (50)	LVBT-2-R	3.1 (1.0)	4
3 (75)	LVBT-2-R	2.0 (0.6)	4
4 (100)	LVBT-4-R	3.1 (1.0)	2
6 (150)	LVBT-4-R	2.0 (0.6)	2



Round Busbar

0.5 (12)	LVBT-1-R	8.0 (2.6)	8
1.0 (25)	LVBT-2-R	8.0 (2.6)	4
2.0 (50)	LVBT-2-R	4.0 (1.3)	4
3.0 (75)	LVBT-2-R	2.6 (0.9)	4
4.0 (100)	LVBT-4-R	4.0 (1.3)	2

ADDITIONAL PRODUCT INFORMATION

- LVBT-1-R is best for shorter lengths. LVBT-2-R is the most versatile width for general purpose use. LVBT-4-R is useful for long lengths and larger bus sizes.
- If sealing is needed, order the S1052-6-150 sealant strips.
- Related Test Reports: EDR-5490 and EDR-5499

HVBT High Voltage Busbar Insulating Tape

8

FEATURES

- Used in applications up to 15 kV in accordance with ANSI/IEEE specifications
- Up to 36 kV in accordance with IEC specifications
- Rated to ANSI/IEEE C37.20-1987.

APPLICATIONS

- TE's Raychem HVBT tape is an adhesive coated, high-voltage, heat-shrinkable, general-purpose tape for insulating straight and bent bars in retrofit applications where tubing cannot be used. In addition, HVBT easily insulates unusual connections and geometries in the factory or field.

BENEFITS

- HVBT tape is also ideal for protection against incidental/accidental bridging caused by birds and animals.
- Unlimited shelf life when stored in normal conditions



HVBT TAPE DIMENSIONS

Catalog Number	Roll width in (mm)	Roll Length Ft (m)
HVBT-1-R-01 (B8)	1 (25)	25 (7.5)
HVBT-2-R-01 (B4)	2 (50)	25 (7.5)
HVBT-4-R-01 (B2) 4"	4 (100)	25 (7.5)

PRODUCT SELECTION INFORMATION: DIMENSIONS IN FEET(M)

Bus Width	Catalog Number	Bus Length Insulated per Roll	Rolls/Standard Pack
-----------	----------------	-------------------------------	---------------------



Rectangular Busbar*			
1 (25)	HVBT-1-R-01 (B8)	2.5 (0.7)	8
2 (50)	HVBT-2-R-01 (B4)	3.3 (1.0)	4
3 (75)	HVBT-2-R-01 (B4)	2.2 (0.6)	4
4 (100)	HVBT-2-R-01 (B4)	1.6 (0.5)	4
6 (150)	HVBT-2-R-01 (B4)	1.0 (0.3)	4
8 (200)	HVBT-4-R-01 (B2)	1.6 (0.5)	4

*Maximum thickness: 5/8 (15)



Square Busbar			
1 x 1 (25)	HVBT-2-R-01 (B4)	4.0 (1.2)	4
2 x 2 (50)	HVBT-2-R-01 (B4)	2.0 (0.6)	4
3 x 3 (75)	HVBT-2-R-01 (B4)	1.3 (0.4)	4
4 x 4 (100)	HVBT-4-R-01 (B2)	2.0 (0.6)	2
6 x 6 (150)	HVBT-4-R-01 (B2)	1.3 (0.4)	2



Round Busbar			
0.5 (12)	HVBT-1-R-01 (B8)	5.0 (1.5)	8
1.0 (25)	HVBT-2-R-01 (B4)	5.0 (1.5)	4
2.0 (50)	HVBT-2-R-01 (B4)	2.5 (0.7)	4
3.0 (75)	HVBT-2-R-01 (B4)	1.5 (0.4)	4
4.0 (100)	HVBT-4-R-01 (B2)	2.5 (0.7)	2

ADDITIONAL PRODUCT INFORMATION

- Select the appropriate catalog number for the application. Confirm selection with the following recommendations and HVBT tape dimensions: HVBT-1-R is best for short lengths and small bus sizes, HVBT-2-R is the most versatile width for general purpose use, HVBT-4-R is useful for long lengths and larger bus sizes.
- To environmentally seal the bus, order order S1251-50-300-1 or S1251-25-300-4 sealant strips separately.
- Recommended application is to wrap the tape around the busbar using a two-thirds overlap.
- Bolted connections require two layers of tape.
- Standard package: HVBT-1-R: 8 rolls/box, HVBT-2-R: 4 rolls/box, HVBT-4-R: 2 rolls/box
- Continuous operating temperature: 90°C
- Related test reports: UVR-8023, EDR-5154 and EDR-5466.

Hot-Melt and Cold-Applied Sealants (Mastic)

FEATURES

- The hot-melt sealants flow when heated and set when cooled to provide a superior watertight seal. The cold-applied sealants bond to surfaces when placed under pressure to create a watertight seal.

APPLICATIONS

- Used for sealing the ends of uncoated tubing or for low-voltage applications requiring void-filling.

BENEFITS

- ♦ Use sealants with uncoated tubing and molded parts for sealing applications or as an adhesion enhancement for specific applications.

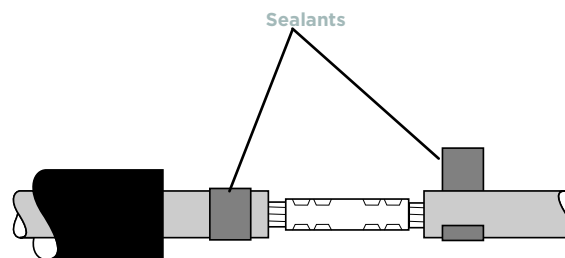

PRODUCT SELECTION INFORMATION

Sealant Type	Description	Use with These Products	Application
S1052	General purpose low-voltage sealant	WCSM-A/U (uncoated), MWTM-A/U (uncoated), FCSM-A/U (uncoated), LVBT, LVIT	heat shrink
S1085	General purpose high-voltage sealant	HVS (high-voltage splices), HVT (high-voltage terminations)MCK-5	heat shrink cold applied
S1189	High-temperature, low-voltage sealant	MCK, HVS, HVT	heat shrink
S1251	High-voltage Raysulate electrical insulator sealant	BBIT, BPTM, HVBC, HVBT, HVIS, HVS, JGK	heat shrink
S1171	Low-voltage mining sealant	LV-MSK, HV-MSK	heat shrink
S1174	Low-voltage mining sealant	MCK	heat shrink
S1278	Low-voltage sealant	RDSS, CATS, CSJ, TFT, ELB	cold applied
GelWrap Pad	Low-voltage PowerGel sealing gel	GelWrap, GelWrap-RS closure	cold applied

Catalog Number	Color	(Width x Length x Thickness)	Standard Pack
S1052-3-3000-(B5)	Black	Roll: 1.5 x 120 x .12	5 rolls/box
S1085-3-380 (B15)	Black		
S1171-4-300 (B100)	Black	Strip: 2 x 12 x .10	100 strips/box
S1174-2-300(B25)	Black	Strip: .5 x 12 x .09	25 strips/box
S1174-4-460	Black	Strip: 1 x 18 x .19	15 strips/box
S1251-25-300-4(B25)	Red	Strip: 1 x 12 x .150	25 strips/box
S1251-50-300-1(B25)	Red	Strip: 2 x 12 x .045	25 strips/box
S1278-3x61x7620(S1)	Gray	Roll: 2.4 x 300 x .12	1 roll/box
Gelwrap-Pad-2X8(B6)	Gray	Strip: 2 x 8 x .18	6 strips/box
S1189-3-600 (B25)	Yellow		

ADDITIONAL PRODUCT INFORMATION

- Select the appropriate catalog number based on the application information in columns two and three of the above table.
- Use the information in the table above for ordering.
- Sealants are supplied in bulk form with protective release paper.





Chapter 9

Photocontrols & Accessories

Thermal Photocontrol	256
Electronic Photocontrol	260
Lighting Accessories	265



AT Series

FEATURES

- Tough die-cast aluminum housing
- Heavy-duty thermal bimetal switch
- UL and CSA listed
- 30-45 second time delay
- 2000 & 3000 Watt load ratings
- Fail mode is ON

APPLICATIONS

- Wire-in dusk to dawn control effectively switches luminaires with incandescent, HID, LED, or compact fluorescent lamps.

BENEFITS

- ♦ The rugged die-cast aluminum housing of the AT Series makes it the ideal choice for outdoor lighting applications where a risk of vandalism or physical damage exists.
- ♦ The time delay eliminates unwanted lamp cycling caused by lightning, car headlights, or other sudden changes in the ambient light level.



156D
E45412



Certified
LR27428

PRODUCT SELECTION INFORMATION

Catalog Number	Rated Volts	Range (volts)	Load Rating		Turn ON (Fc)	OFF/ON Ratio
			Tungsten (watts)	Ballast (VA)		
AT-15	120	105-130	2000	1900	1.5	6:1
AT-168	208/240/277	185-305	2000	1900	1.5	6:1
AT-19*	480	420-530	2000	1900	1.5	6:1
AT-20	120/208/240/277	105-305	2000	1900	1.5	6:1
AT-30*	120	105-130	3000	2900	1.5	6:1
AT-368*	208/240/277	185-305	3000	2900	1.5	6:1
AT-39*	480	420-530	3000	2900	1.5	6:1

Note: 6 inch Lead wires
*Not UL or CSA Listed

PT | SPT Series

FEATURES

- Fixed or adjustable non-metallic housing swivel base
- Heavy duty thermal bimetal switch
- UL and CSA listed
- 30-45 second time delay
- 2000 Watt load rating
- Fail mode is ON
- Adjustable slide bar allows field adjustment of light exposure to photo eye to meet specific needs

APPLICATIONS

- Wire-in dusk to dawn control effectively switches luminaires with incandescent, HID, LED, or compact fluorescent lamps.

BENEFITS

- ♦ PT and SPT series controls combine the superior performance of the AT series with an economical, yet highly durable, polycarbonate housing
- ♦ The time delay eliminates unwanted lamp cycling caused by lightning, car headlights, or other sudden changes in the ambient light level.

PT/SPT Series



156D
E45412



Certified
LR27428

PRODUCT SELECTION INFORMATION

Catalog Number	Base	Rated Volts	Range (volts)	Load Rating		Turn ON (Fc)	OFF/ON Ratio
				Tungsten (watts)	Ballast (VA)		
PT Series							
PT-15	Fixed	120	105-130	2000	1900	1.5	5:1
PT-168	Fixed	208/240/277	185-305	2000	1900	1.5	5:1
PT-20	Fixed	120/208/240/277	105-305	2000	1900	1.5	5:1
PT-347**	Fixed	347	310-380	2000	1900	1.5	5:1
SPT Series							
SPT-15	Swivel	120	105-130	2000	1900	1.5	5:1
SPT-168	Swivel	208/240/277	185-305	2000	1900	1.5	5:1
SPT-19*	Swivel	480	420-530	2000	1900	1.5	5:1
SPT-347**	Swivel	347	310-380	2000	1900	1.5	5:1

Note: 6 inch Lead wires
*Not UL or CSA Listed **CSA listed only

TL Series

FEATURES

- Slim Profile
- Adjustable swivel base
- 30-45 second time delay
- UL and CSA listed
- Durable polycarbonate housing
- Fail mode is ON

APPLICATIONS

- Wire-in dusk to dawn control effectively switches luminaires with incandescent, HID, LED, or compact fluorescent lamps.

BENEFITS

- ♦ The TL Series offers a thin cylindrical shape to fit neatly between twin floodlights or in other tight applications.
- ♦ The time delay eliminates unwanted lamp cycling caused by lightning, car headlights, or other sudden changes in the ambient light level.



PRODUCT SELECTION INFORMATION

Catalog Number	Rated Volts	Range (volts)	Load Rating		Turn ON (Fc)	OFF/ON Ratio
			Tungsten (watts)	Ballast (VA)		
TL-115	120	105-130	1800	1100	1.5	5:1
TL-1168	208/240/277	185-305	1200	1100	1.5	5:1

Note: 6 inch Lead wires



AA Series

FEATURES

- 3/4 inch button style long threaded nipple
- 30-45 second time delay
- UL and CSA listed
- Durable polycarbonate housing
- 1800 and 1200 Watt load rating
- Fail mode is ON

APPLICATIONS

- Button style control designed for flush mount or internal mounting effectively switches luminaires with incandescent, HID, LED, or compact fluorescent lamps.

BENEFITS

- ♦ The AA series control is designed for internal mounting and is constructed of a high impact, UV stabilized polycarbonate housing.
- ♦ The wire leads exit from the rear allowing the control to be placed in tight locations while positioning the wiring for easy access.
- ♦ The AA-105W and AA-1068W controls include a brushed aluminum wall plate for installation in standard outlet boxes.



PRODUCT SELECTION INFORMATION

Catalog Number	Product Information	Rated Volts	Range (volts)	Load Rating		Surge Protection (Joules)	Turn ON (Fc)	OFF/ON Ratio
				Tungsten (watts)	Ballast (VA)			
AA-105		120	105-130	1800	1100		1.5	5:1
AA-105W	w/Wall Plate	120	105-130	1800	1100		1.5	5:1
AA-1068		208/240/277	185-305	1200	1100		1.5	5:1
AA-1068W	w/Wall Plate	208/240/277	185-305	1200	1100		1.5	5:1
AA-305		120	105-130	300	840		1.5	5:1
AA-105M	15" Leads	120	105-130	1800	1100	180	1.5	5:1
AA-1068M	15" Leads	208/240/277	185-305	1200	1100	180	1.5	5:1
AA-105HA	High Ambient	120	105-130	1800	1100		1.5	5:1

Note: 6 inch Lead wires unless otherwise noted

LC Series

FEATURES

- Locking Style/Residential Grade
- Heavy-duty thermal bimetal switch
- 30-45 second time delay
- UL and CSA listed
- ANSI C136.10 compliant
- Fail mode is ON

APPLICATIONS

- LC controls are a perfect and reliable solution for lighting driveways, patios, decks, entryways or other areas around the home where security lighting is desired.

BENEFITS

- ♦ The LC series locking-type photocontrols offer an economical and cost-effective means of controlling residential lighting systems from dusk to dawn.



128F
PHOTOCONTROL
E66375



Certified
LR27428

ANSI Standard Cap Colors

120V	Clear
208/240/277V	Maroon

PRODUCT SELECTION INFORMATION

Catalog Number	Rated Volts	Range (volts)	Load Rating		Turn ON (Fc)	OFF/ON Ratio
			Tungsten (watts)	Ballast (VA)		
LC-120	120	105-130	1000	1800	1.5	4:1
LC-208-277	208/240/277	185-305	1000	1800	1.5	4:1

BF Series

FEATURES

- Locking style/industrial/commercial grade with surge protection
- 180 Joule MOV surge protection
- Heavy-duty thermal bimetal switch
- 30-45 second time delay
- UL and CSA listed
- ANSI C136.10 compliant
- Fail mode is ON

APPLICATIONS

- The BF series locking-type photocontrols are engineered to meet the needs of virtually every commercial and industrial outdoor lighting control application utilizing HID luminaires equipped with locking-style receptacles. Typical applications include parking lots, security lighting, street, and other types of area lighting.

BENEFITS

- ♦ Heavy-duty thermal bi-metal switch produces a minimum 30-45 second time delay, eliminating unwanted off/on operations that could be caused by lightning, car headlights, or other sudden changes in the ambient light level. BF controls are also equipped with a 180 joule MOV to protect both the photocontrol and the luminaires from sudden surges in the line voltage.

BF Series



128F
PHOTOCONTROL
E66375



Certified
LR27428

ANSI Standard Cap Colors

120V	Gray
208/240/277V	Maroon
120/208/240/277V	Blue

PRODUCT SELECTION INFORMATION

Catalog Number	Rated Volts	Range (volts)	Load Rating		Surge Protection (Joules)	Turn ON (Fc)	OFF/ON Ratio
			Tungsten (watts)	Ballast (VA)			
BF-120	120	105-130	1000	1800	180	1.5	5:1
BF-208-277	208/240/277	185-305	1000	1800	180	1.5	5:1
BF-PV	120 or 208/240/277	105-305	1000	1800	180	1.5	5:1

M Series

FEATURES

- Locking style/industrial grade with surge protection
- 180 or 360 Joule MOV surge protection
- Heavy-duty thermal bimetal switch
- 30-45 second time delay
- UL and CSA listed
- ANSI C136.10 compliant
- Fail mode is ON

APPLICATIONS

- M series photocontrols are engineered to meet the demanding needs of utility street lighting control.

BENEFITS

- ♦ All M series controls are equipped with a 180 or 360 Joule Metal Oxide Varistor (MOV) to protect both the control and the luminaries against sudden surges in the line voltage, as well as a 1 inch CdS cell to maximize the photocontrol's useful life.



ANSI Standard Cap Colors	
120V	Gray
208/240/277V	Maroon
120/208/240/277V	Blue
480V	Yellow



128F
PHOTOCONTROL
E66375



Certified
LR27428

PRODUCT SELECTION INFORMATION

Catalog Number	Rated Volts	Range (volts)	Load Rating		Surge Protection (Joules)	Turn ON (Fc)	OFF/ON Ratio
			Tungsten (watts)	Ballast (VA)			
M-120	120	105-130	1000	1800	180	1.5	5:1
M-208-277	208/240/277	185-305	1000	1800	180	1.5	5:1
M-480*	480	420-530	1000	1800	180	1.5	5:1
M-PV	120 or 208/240/277	105-305	1000	1800	180	1.5	5:1
M-347**	347	310-380	1000	1800	180	1.5	5:1

* Not UL or CSA Listed

** CSA Listed Only

3000 Series Electronic/Heavy Duty/N.O. Contact

FEATURES

- Heavy duty utility grade electronics
- 180 or 360 Joule MOV surge protection
- 2-5 second ON and OFF time delay
- Non-drifting phototransistor, optional IR filtered
- Rain-tight / dust-tight housing
- ANSI C136.10 compliant
- Fail mode is OFF
- 3100 series has inverse OFF/ON ratio

APPLICATIONS

- Roadway Lighting, Parking Lot Lighting, Street Lighting

BENEFITS

- ♦ TE's 3000 Series provides a unique mix of long-life, multi-volt and fail OFF operation demanding roadway lighting applications. Like all of our electronic controls, the 3000 Series utilizes our interlocking base/cap design for superior environmental protection.



PRODUCT SELECTION INFORMATION

Catalog Number	Rated Volts	Range (volts)	Load Rating		Surge Protection (Joules)	Turn ON (Fc)	OFF/ON Ratio
			Tungsten (watts)	Ballast (VA)			
3090-NPS	120/208/240/277	105-305	1000	1800	180	1.5 +/- 0.5	1.5:1
3090-VFS	120/208/240/277	105-305	1000	1800	360	1.5 +/- 0.5	1.5:1

Note: Custom models can be configured based on chart below.

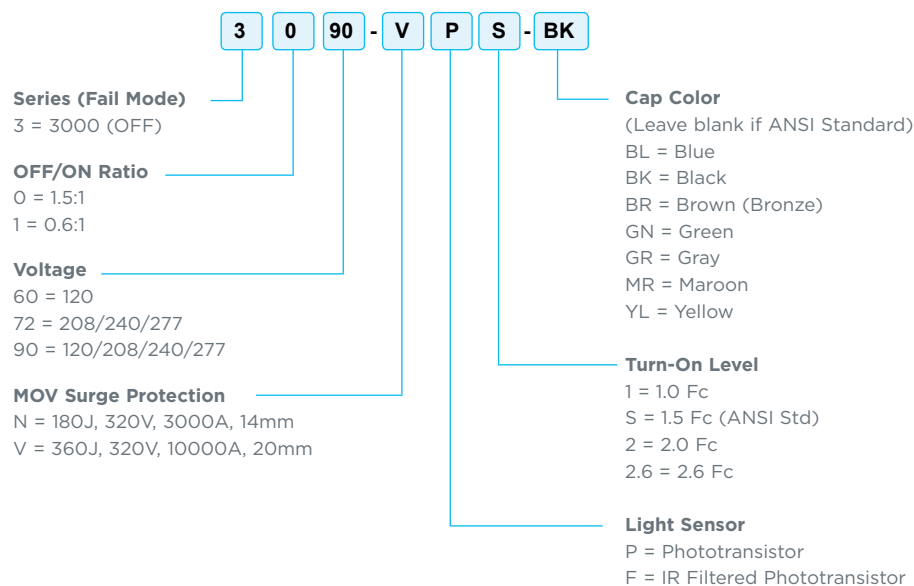

6000 Series

FEATURES

- Electronic heavy duty premium grade
- Long life, high reliability
- 30 Amp relay
- MOV surge protection
- Non-drifting phototransistor
- Instant ON / 2-5 second OFF time delay
- Rain-tight / dust-tight housing
- ANSI C136.10 compliant
- Fail mode is ON

APPLICATIONS

- Roadway Lighting, Parking Lot Lighting, Street Lighting

BENEFITS

- ♦ TE's 6000 Series provides a unique mix of low-cost, long-life and multi-volt operation for demanding Roadway Lighting applications. Like all of our Electronic controls, the 6000 Series utilizes our interlocking base/cap design for superior environmental protection and its expected life is far greater than 10 years.



ANSI Standard Cap Colors	
120V	Gray
208/240/277V	Maroon
120/208/240/277V	Blue

PRODUCT SELECTION INFORMATION

Catalog Number	Rated Volts	Range (volts)	Load Rating		Surge Protection (Joules)	Turn ON (Fc)	OFF/ON Ratio
			Tungsten (watts)	Ballast (VA)			
6060-VPS	120	105-130	2000	1800	360	1.5	1.5:1
6090-VPS	120/208/240/277	105-305	2000	1800	360	1.5	1.5:1
6090-VPS-UL	120/208/240/277	105-305	1000	1800	545	1.5	1.5:1

Note: UL indicates a UL listed product
 Note: Custom models can be configured based on chart below.

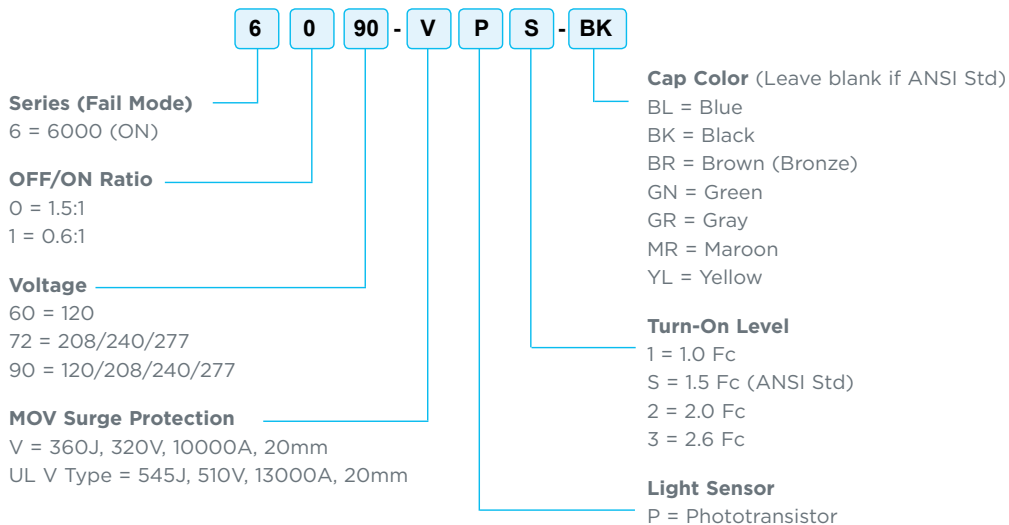

7000 Series Utility-Grade

FEATURES

- Long life, high reliability
- 30 Amp relay
- 480 Joule surge protection
- Non-drifting phototransistor, optional IR filtered
- Instant ON / 2-5 second OFF time delay
- Rain-tight / dust-tight housing
- ANSI C136.10 compliant
- Fail mode Is ON
- Standard pack 100 units that are in individual bags

APPLICATIONS

- Roadway Lighting, Parking Lot Lighting, Street Lighting

BENEFITS

- ♦ TE's 7000 Series provides a unique mix of low-cost, long-life and multi-volt operation for demanding Roadway Lighting applications. Like all of our Electronic controls, the 7000 Series utilizes our interlocking base/cap design for superior environmental protection and its expected life is far greater than 10 years. Available as an option, the IR Filtered Phototransistor gives a human eye response along with long-term, drift-free light sensing.



ANSI Standard Cap Colors	
120V	Gray
208/240/277V	Maroon
120/208/240/277V	Blue

PRODUCT SELECTION INFORMATION

Catalog Number	Rated Volts	Range (volts)	Load Rating		Surge Protection (Joules)	Turn ON (Fc)	OFF/ON Ratio
			Tungsten (watts)	Ballast (VA)			
7060-VPS	120	105-130	1000	1800	480	1.5+/-0.5	1.5:1
7090-VPS	120/208/240/277	105-305	1000	1800	480	1.5+/-0.5	1.5:1
7090-VPS-BK	120/208/240/277	105-305	1000	1800	480	1.5+/-0.5	1.5:1

Note: Custom models can be configured based on chart below.

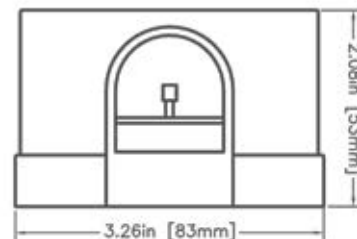
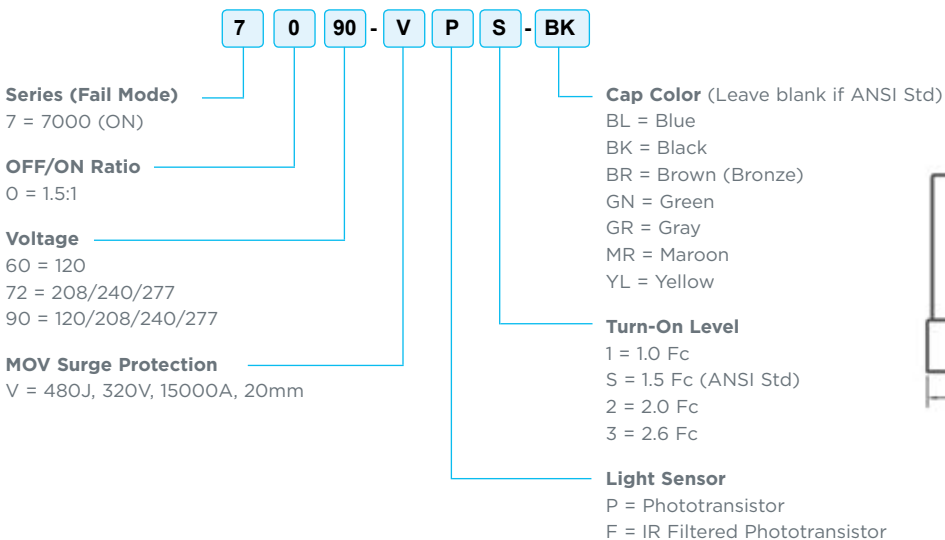

8000 Series Long-Life

FEATURES

- Electronic heavy duty premium grade
- 20 year rated life
- Multi-Volt Operation
- High-Temp Housing and Components
- Meets or exceeds ANSI C136.10

APPLICATIONS

- Designed specifically with the long-life requirements of LED street lighting applications in mind.
- ♦ TE's advanced technology 8000 Series provides a unique, durable, multi-volt control especially designed for twenty year operation.

BENEFITS

- ♦ The 8000 Series utilizes interlocking base/cap design for superior environmental housing. High temperature base material, rated at a minimum 138°C, along with a UV stabilized, opaque housing ensure our control will last over 20 years without degradation.
- ♦ TE uses a process of IR filtering a phototransistor which in turn gives a human eye response along with long-term, drift free light sensing for the life of the control.



Specifications	
Physical:	Dimensions - approx. 3.26" (83mm) dia. x 1.77" (45mm) high (Not including contacts) Enclosure - designed to meet ANSI C136.10 Power consumption - less than 0.5 Watt at 120 VAC
Temperature:	Minus 40°C to plus 65°C at 96% RH
Control:	Exceeds 20,000 ON/OFF operations Solid State Switch Type
Relay Rating:	30 Amp
Load Rating:	1000 Watt Tungsten 1800 VA
Light Sensor:	Non-drifting phototransistor

PRODUCT SELECTION INFORMATION

Catalog Number	Rated Volts	Range (volts)	Load Rating		MOV	Turn ON (Fc)	OFF/ON Ratio
			Tungsten (watts)	Ballast (VA)			
8090-VFS	120/208/240/277	105-305	1000	1800	25mm, 20kA, 300 Joule	1.5	1.5:1

Note: Custom models can be configured based on chart below.

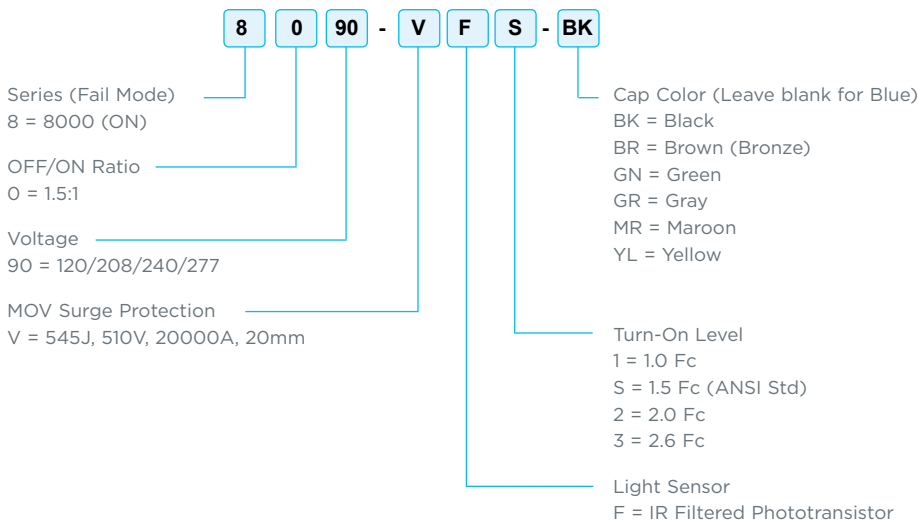

SST Series

FEATURES

- Electronic heavy duty with time delay
- Energy saving inverse OFF/ON ratio
- 30 Amp relay / microprocessor controlled
- MOV surge protection
- Non-drifting phototransistor
- 20-40 second ON and OFF time delay
- Rain-tight / dust-tight housing
- ANSI C136.10 compliant
- Fail mode is ON

APPLICATIONS

- SST Series offers a low-cost and energy saving control for demanding lighting applications.

BENEFITS

- ♦ The SST features a heavy-duty DC magnetic switch that provides high shock and vibration resistance, as well as a 20 - 40 second ON and OFF time delay which eliminates any chance of unwanted luminaire cycling caused by lightning, car headlights, or other sudden changes in ambient light. The SST's light sensor is a non-drifting phototransistor that ensures consistent and uniform switching over the life of the control.



128F
PHOTOCONTROL
E66375

ANSI Standard Cap Colors	
120V	Gray
208/240/277V	Maroon
120/208/240/277V	Blue
480V	Yellow

PRODUCT SELECTION INFORMATION

Catalog Number	Rated Volts	Range (volts)	Load Rating		Surge Protection (Joules)	Turn ON (Fc)	OFF/ON Ratio
			Tungsten (watts)	Ballast (VA)			
SST-PV	120/208/240/277	105-305	1000	1800	180	1.5 +/- 0.5	0.6:1
SST-PV-IES	120/208/240/277	105-305	1000	1800	180	3.0 +/- 0.5	0.6:1
SST-PV-IES-UL	120/208/240/277	105-305	1000	1800	545	3.0 +/- 0.5	0.6:1

Note: UL indicates a UL listed product

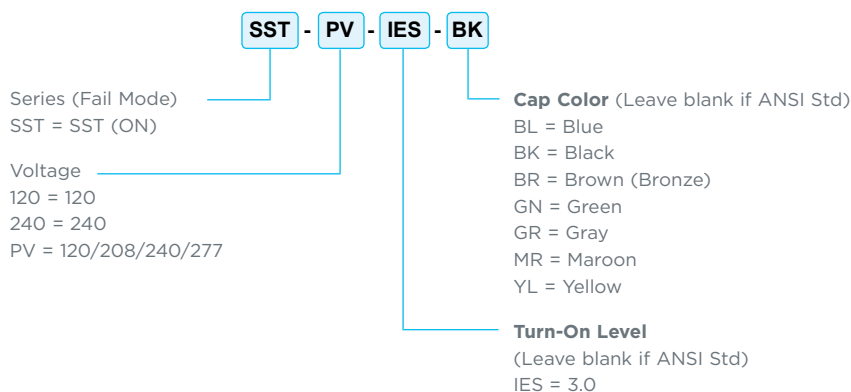

AMR Series

FEATURES

- Perfect for group control applications
- 30 Amp relay
- 3000 Watt rating per pole
- SPDT or DPST switching

APPLICATIONS

- The AMR series offers a durable weatherproof relay to switch multiple lights (Roadway Lighting, Parking Lot Lighting, Street Lighting) with one photocontrol.

BENEFITS

- ♦ Units are comprised of a 3-pole locking style receptacle and a heavyduty 30 Amp relay that increases the load switching capacity of a single photoelectric control to 3,000 Watts per pole.

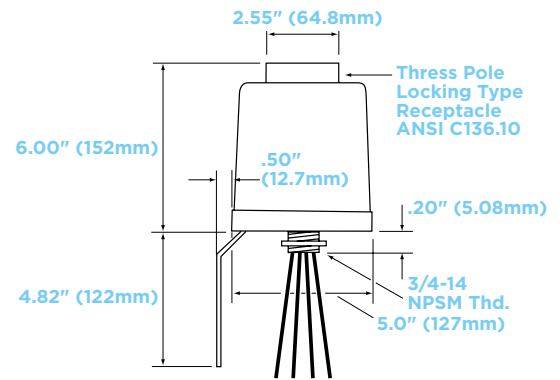
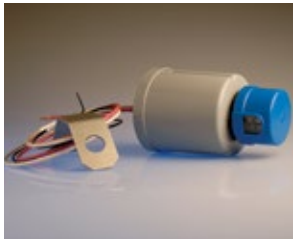

PRODUCT SELECTION INFORMATION

Catalog Number	Rated Volts	Range (volts)	Ballast (VA)/ Pole	Load Rating (Amps)	Switch	Switch Contacts
AMR3030.2-120V	120	105-130	3600	30	SPDT	1 NO/ 1 NC
AMR3030.3-120V	120	105-130	3600	30	DPST	2 NO

Note: 12 inch Lead wires

Shorting and Open Caps

FEATURES

- Designating ANSI in the part number will provide you a unit with a stepped housing dictated in the latest ANSI C136.10 specification. This unique housing makes it easier for users to distinguish visually between a standard photocontrol and a shorting or open cap.
- Shorting and non-shorting models
- Optional surge protection

APPLICATIONS

- SC, MC and NS caps provide a convenient and economical method to close or open the primary circuit with a NEMA locking type receptacle.

BENEFITS

- ♦ Durable materials and gasket provide both long life and weatherproof protection.



PRODUCT SELECTION INFORMATION

Catalog Number	Circuit Type	Cap Color	Load Rating Tungsten (watts)	Ballast (VA)	Surge Protection (Joules)
SC-10A*	Shorting	Clear	1000	1800	-
SC-10ANSI**	Shorting	Black	1000	1800	-
MC-10	Shorting	Black	1000	1800	360
MC-10ANSI**	Shorting	Black	1000	1800	360
NS-10	Open	Maroon	1000	1800	-
NS-10ANSI**	Open	Red	1000	1800	-

* UL Listed

**ANSI C136.10-2006 Compliant



128F
PHOTOCONTROL
E66375



AM Series

FEATURES

- Phosphor bronze contacts
- Thermal-set phenolic base
- UL Recognized component
- Voltage range: 120 - 480 VAC
- Meets ANSI C136.10

APPLICATIONS

- The AM Series is designed specifically for street, roadway and outdoor lighting applications. This 3-pole, 3-wire locking type receptacle conforms to the ANSI, NEMA, and UL standards for non-dimming lighting receptacles.

BENEFITS

- ♦ Long life and weatherproof locking style receptacle



PRODUCT SELECTION INFORMATION

Catalog Number	Load Rating		Flange Diameter	Barrel Diameter	Receptacle Height	Overall Lead Length	Bracket		
	Ballast (VA)	Ballast (Amps)					Width	Depth	Height
AM-1-A	1800	15.0	2/9/16	1/3/08	1/1/02	9	2.0	3 1/2	5 1/2
AM-1-A-NB	1800	15.0	2/9/16	1/3/08	1/1/02	9	-	-	-
AM-2-A	1800	15.0	2/9/16	-	3/1/03	6	2.0	3 1/2	5 1/2
AM-2-A-NB	1800	15.0	2/9/16	-	3/1/04	6	-	-	-

US-30 Starter

FEATURES

- Universal 3-wire design
- Hermetically sealed components
- Durable ABS housing
- Operates with 35 to 400 Watt HPS ballasts

APPLICATIONS

- The US-30 starter is a universal starting aid designed to operate with most 3-wire HPS ballasts from 35 to 400 watts and with 55 or 100-volt arc tube lamps.

BENEFITS

- ♦ This one starter does the job of dozens of different 3-wire starters. The US-30 starter is a state-of-the-art device that generates the spike required for lamp ignition, then discontinues the spike after lamp ignition to prevent damage to luminaries' components. The US-30's components are hermetically sealed to prevent damage from contaminants or adverse environmental conditions, and its wire leads are color coded for ease of installation and maintenance.



PRODUCT SELECTION INFORMATION

Catalog Number	Lead Connector	Lamp Voltage	Lamp Wattage
US-30	None	50 or 100	35-400

OLC/PL/ACL Series

FEATURES

- Fast and simple to install - screw-in design, no hard wiring.
- Designed for outdoor and indoor use
- Fail Mode is ON

APPLICATIONS

- The PL-120S control is designed for indoor or outdoor use and has a small profile that fits easily into most outdoor post lanterns. The OLC-5C controls outdoor Par-38 flood or spotlights to providing dusk-to-dawn security lighting for driveways, entranceways, and patios.

BENEFITS

- ♦ PL and OLC controls offer two effective and economical ways to control incandescent lighting.



PRODUCT SELECTION INFORMATION

Catalog Number	Rated Volts	Range (volts)	Tungsten (watts)	Load Rating CDS Cell
CPGI-ALR-PL-120S	120	105-130	150	1/8
CPGI-ALR-PL-120S-B	120	105-130	150	1/8
CPGI-ALR-OLC-5C	120	105-130	150	1/4
CPGI-ALR-ACL-11*	120	105-130	400	1/8

* ACL controls are designed for incandescent loads only





Chapter 10

TE's Raychem

Wildlife and Asset Protection

BUS Insulation & Wildlife Protection	270
Substations	276
Overhead	288
Contamination/Flashover Prevention	295

HVBT High Voltage Busbar Insulating Tape

FEATURES

- Superior UV resistance
- Insulates up to 35 kV when two layers are applied at 2/3 overlap.
- Compatible with all other products in the TE's Raychem medium voltage insulation enhancement system
- Easy to apply using readily available equipment
- Suitable for both indoor and outdoor use
- Excellent anti-tracking properties
- Continuous operating temperature up to 90 °C
- Extremely versatile and flexible at temperatures as low as -40 °C, the 30% shrink ratio enables coverage of almost any shape
- Good thermal emissivity and contact with busbars means no derating is required
- Can be stored indefinitely at temperatures up to 50 °C without loss of performance

APPLICATIONS

- TE's Raychem HVBT tape offers a simple and effective solution to the problems of retrofit insulation of busbars, particularly where existing equipment cannot be dismantled.
- Can be used for indoor and outdoor applications and is easily installed over a wide variety of shapes, including complex connections.
- May be used in applications 15 kV in accordance with ANSI/IEEE specifications and up to 36 kV in accordance with IEC Specifications.

BENEFITS

- ♦ Protects against incidental/ accidental bridging caused by birds and animals.
- ♦ The HVBT adhesive layer fuses the tape layers, but does not stick to the bus or hardware, providing environmental sealing while allowing fast, easy removal
- ♦ Manufactured from non-halogen based materials, reducing the toxic and corrosive effects in the event of fire

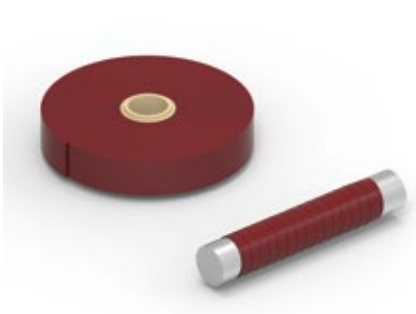

RECTANGULAR BUSBAR

Bus Width* in (mm)	Recommended Product	Bus Length Insulated per Roll feet (meters)
1 (25)	HVBT-1-R-01 (B8)	2.5 (0.7)
2 (50)	HVBT-2-R-01 (B4)	3.3 (1.0)
3 (75)	HVBT-2-R-01 (B4)	2.2 (0.6)
4 (100)	HVBT-2-R-01 (B4)	1.6 (0.5)
6 (150)	HVBT-2-R-01 (B4)	1.0 (0.3)
8 (200)	HVBT-4-R-01 (B2)	1.6 (0.5)

*Calculated with maximum thickness: 5/8 inch (15mm)



SQUARE BUSBAR

Dimensions of bar inch (mm)	Recommended Product	Bus Length Insulated per Roll feet (m)
1 x 1 (25)	HVBT-2-R-01 (B4)	4.0 (1.2)
2 x 2 (50)	HVBT-2-R-01 (B4)	2.0 (0.6)
3 x 3 (75)	HVBT-2-R-01 (B4)	1.3 (0.4)
4 x 4 (100)	HVBT-4-R-01 (B2)	2.0 (0.6)
6 x 6 (150)	HVBT-4-R-01 (B2)	1.3 (0.4)



ROUND BUSBAR

Busbar Diameter inch (mm)	Recommended Product	Bus Length Insulated per Roll feet (m)
0.5 (12)	HVBT-1-R-01 (B8)	5.0 (1.5)
1.0 (25)	HVBT-2-R-01 (B4)	5.0 (1.5)
2.0 (50)	HVBT-2-R-01 (B4)	2.5 (0.7)
3.0 (75)	HVBT-2-R-01 (B4)	1.5 (0.4)
4.0 (100)	HVBT-4-R-01 (B2)	2.5 (0.7)

PRODUCT SELECTION INFORMATION:

Catalog Number	Roll Width Roll Length	Standard Package
HVBT-1-R-01 (B8)	1 inch 25 feet	8 rolls/box
HVBT-2-R-01 (B4)	2 inches 25 feet	4 rolls/box
HVBT-4-R-01 (B2)	4 inches 25 feet	2 rolls/box

ADDITIONAL PRODUCT INFORMATION

- Select the appropriate catalog number for the application. Confirm selection with the following recommendations and TE's HVBT tape dimensions:
 - HVBT-1-R is best for short lengths and small bus sizes.
 - HVBT-2-R is the most versatile width for general purpose use.
 - HVBT-4-R is useful for long lengths and larger bus sizes.
- To environmentally seal the bus, order S1251-50-300-1 or S1251-25-300-4 sealant strips separately.
- Recommended application is to wrap the tape around the busbar using a two-thirds overlap.
- Bolted connections require two layers of tape.
- Continuous operating temperature: 90 degrees Celsius.
- Related Test reports: UVR-8023, EDR-5154, and EDR-5466

BBIT / BPTM Busbar Insulating Tubing

FEATURES

- TE's Raychem BBIT/BPTM tubes are extremely flexible which allows for easy positioning
- Have a high expansion ratio, so each size of tubing fits a range of busbar sizes
- Quick installation with the use of a gas torch or oven

APPLICATIONS

- Ideal for protection against accidental bridging caused by birds and other animals
- Can be used on straight or bent bars where clearance reduction or insulation are required
- Ideal for original equipment assembly, and for retrofit applications where access to one end is available

BENEFITS

- Easy installation
- Flexible
- Fits a range of busbar sizes
- Versatile tubing covering a range from 5-35 kV for electrical insulation

PRODUCT SELECTION INFORMATION: DIMENSIONS IN INCHES (MM)



Catalog Number	Rectangular Bar (bus width)	Square Bar (each side)	Round Bar (diameter min-max)	Diameter as Supplied and Fully Recovered
BBIT-25/10-A/U	0.5 (12)		0.50-0.70 (12-18)	0.98-0.39 (25-10)
BBIT-40/16-A/U	1.0 (25)		0.70-1.10 (18-28)	1.57-0.63 (40-16)
BBIT-65/25-A/U	2.0 (50)	1.0 (25)	1.10-1.55 (28-40)	2.56-0.98 (65-25)
BBIT-100/40-A/U	3.0 (75)	2.0 (50)	1.75-2.45 (44-62)	3.94-1.57 (100-40)
BBIT-150/60-A/U	4.0 (100)	3.0 (75)	2.60-3.60 (66-91)	5.91-2.36 (150-60)
BBIT-175/80-A/U	5.0-6.0 (125-150)	4.0 (100)	3.45-4.75 (88-121)	6.89-3.15 (175-80)

Catalog Number*	Rectangular Bar		Square Bar		Round Bar		Diameter as Supplied and Fully Recovered
	5 - 15 kV	25 kV	5 - 15 kV	25 kV	5 - 15 kV	25 kV	
BPTM-15/6-A/U	N/A	N/A	N/A	N/A	0.26-0.52 (7-13)	0.26-0.52 (7-8)	0.59-0.24 (15-6)
BPTM-30/12-A/U(B50)	0.25-0.5 (12)		0.5 (12)	0.5 (12)	0.53-0.90 (14-23)	0.53-0.65 (14-16)	1.18-0.47 (30-12)
BPTM-50/20-A/U(B50)	1.0 (25)	1.0 (25)	1.0 (25)	N/A	0.90-1.35 (23-33)	0.90-1.10 (23-28)	1.97-0.79 (50-20)
BPTM-75/30-A/U(B50)	2.0 (50)	2.0 (50)	1.5 (38)	1.0 (25)	1.30-2.00 (33-51)	1.30-1.65 (33-42)	2.95-1.18 (75-30)
BPTM-100/40-A/U(B50)	3.0 (75)	3.0 (75)	2.0 (50)	1.5 (38)	1.75-2.75 (44-70)	1.75-2.30 (44-58)	3.94-1.57 (100-40)
BPTM-120/50-A/U(B50)	4.0-5.0 (100-127)	4.0 (100)	3.0 (75)	2.0 (50)	2.15-4.00 (55-102)	2.15-3.20 (55-81)	4.72-1.97 (120-50)
BPTM-175/70-A/U(B50)	6.0-7.0 (150-178)	5.0-6.0 (127-150)	4.0 (100)	3.0 (75)	3.20-5.50 (81-140)	3.20-4.40 (81-112)	6.88-2.75 (175-70)
BPTM-205/110-A/U(B50)	8.0 (200)	8.0 (200)	5.0 (127)	4.0 (100)	4.75-7.00 (120-178)	4.75-6.80 (120-174)	8.07-4.33 (205-110)
BPTM-235/130-A/U-C(40)	12 (300)	10 (250)	6.0 (150)	6.0 (150)	5.70-8.45 (145-215)	5.70-8.07 (145-205)	9.25-5.12 (235-130)

* (Bxx) denotes roll of uncoated tubing per box in feet. BPTM-235/130 comes in a box of 132 feet

ADDITIONAL PRODUCT INFORMATION

- Select the appropriate catalog number. Confirm selection with bus dimensions.
- Rectangular bus thickness range is 1/4 to 5/8 inch.
- Bolted connections require two layers of tubing or a fiber bolt pad. (BP-46).
- To environmentally seal the bus at each end of the BBIT tubing, order S1251-50-300-1 or S1251-25-300-4 sealant strip separately.
- Standard package:
 - BBIT-25/10-A/U: 65 feet/box
 - BBIT-40/16-A/U: 60 feet/box
 - BBIT-65/25-A/U: 50 feet/box
 - BPTM-235/130-A/U: 132 feet/box
 - All other BPTM sizes: 50 feet/box
- BBIT and BPTM are also available in bulk spooled quantities.
- Related test reports:
 - BBIT-UVR-8136, UVR-8137, BPTM-UVR-8019
- Minimum continuous length is 15 feet (4.5 meters).

HVIS High Voltage Busbar Insulating Sheet

FEATURES

- TE's Raychem HVIS adhesive coated material provides insulation to Busbar/connections and does not adhere to metal.
- Compatible with other Wildlife and Asset Protection products or alone to prevent accidental bridging from birds and animals
- 5-15 kV

APPLICATIONS

- Busbar tees
- Busbar elbows
- Other complex Busbar shapes

BENEFITS

- ♦ Easy to install high performance insulation
- ♦ Product is UV resistant
- ♦ Made of anti-tracking material



PRODUCT SELECTION INFORMATION: DIMENSIONS IN INCHES (MM)

Catalog Number	Width	Length	Packaging
HVIS-05-(B3) NS	26 (660)	20 (508)	Sheet
HVIS-10-(B1) NS	26 (660)	33ft (10m)	Roll

SHEET (HVIS) ACCESSORIES

Catalog Number	Description	Standard Pack
HVIS-Flat (B12)	36" flat bracket for clamping HVIS on straight runs	12 each
HVIS-Angle (B12)	Angle brackets for clamping HVIS at 90 degree angles	12 each
HVIS-Clamp (B25)	Spring clamps to hold brackets on HVIS	25 each

Bus Width	Cut Size Needed	Number of Installations Per HVIS-05 Sheet	Number of Installations per HVIS-10 Roll
T Connection			
1 (25)	11 x 9 (275 x 225)	4	88
2 (50)	13 x 10 (325 x 250)	4	78
3 (75)	16 x 11 (400 x 275)	2	48
4 (100)	18 x 13 (450 x 325)	2	44
6 (150)	22 x 17 (550 x 425)	1	23
Elbow Connection			
1 (25)	11 x 7 (275 x 175)	4	112
2 (50)	13 x 9 (325 x 225)	4	88
3 (75)	15 x 10 (375 x 250)	2	52
4 (100)	18 x 11 (450 x 275)	2	44
6 (150)	22 x 13 (550 x 325)	1	36

ADDITIONAL PRODUCT INFORMATION

- Select the appropriate catalog number. Confirm selection with dimensions.
- Busbars are assumed to be insulated to within one inch of the joint. Cut size should extend a minimum of four inches onto each leg of the joint before shrinking.
- The above table should be used as a guide only; experiment to confirm final cut size. Table is based on 5/8-inch bus thickness period.
- To environmentally seal each leg of the bus, order S1251-50-300-1 or S1251-25-300-4 sealant strips separately.
- HVIS may be rated for applications up to 35kV when two layers are applied.
- Standard package:
HVIS-05: 3 sheets/box
HVIS-10: 1 roll/box
- Related test report: EDR-5175, EDR-5385

RRBB Interphase Insulating Barrier Board

FEATURES

- Non-structural, interphase barrier
- Made from homogeneous polymer
- Easily fabricated into a shape
- Innovative cross-linking resistant material can be wiped clean after power-arc events resulting in no visible effects or surface damage
- Machining properties allow it to be cut and drilled for mounting without requiring special safety equipment
- Extremely durable.

APPLICATIONS

- TE's Raychem RRBB protects switchgear cabinets against interphase flashovers
- UV Resistance makes it suitable for outdoor applications

BENEFITS

- ♦ Excellent track resistance, especially following a power arc
- ♦ Produces less nuisance dust than other boards
- ♦ Produces less tooling wear than other boards
- ♦ Extended life due to the excellent tracking resistant properties
- ♦ High durability makes boards resistant to damage from solvents, mechanical impact and general wear and tear



PRODUCT SELECTION INFORMATION: DIMENSIONS IN INCHES (MM)

Catalog Number	Width	Length	Thickness
RRBB-6-1.25Mx1.25M-(B3)	48 (1220)	48 (1220)	0.250 (6)
RRBB-2440/1220-6.2-BP	48 (1220)	96 (2440)	0.250 (6)

ADDITIONAL PRODUCT INFORMATION

Related Test Report: EDR-5311

HVBC High voltage Cable-to-Bus Insulation

FEATURES

- Kit contains heat shrinkable insulating tubing and sealant strips for insulating and environmentally sealing high voltage in-line cable-to-busbar connections
- Kit contains heat shrinkable sealing boot for multiple cable connections

APPLICATIONS

- TE's Raychem HVBC kits are used with TE's high voltage terminations, the diameter build-up over the cable is minimal
- HVBC may be used in applications up to 15 kV in accordance with ANSI/IEEE specifications, and up to 36 kV in accordance with IEC applications

BENEFITS

- ♦ Kit greatly simplifies field installation and eliminates the labor and skill needed for tape-and-putty methods
- ♦ Increases working space in cramped areas and allows up to four cable connectors



PRODUCT SELECTION INFORMATION:

Catalog Number		Number of Cables	Cable Size Range (Min - Max)
Bus width: 2 - 4 inches	Bus width: 5 - 6 inches		
HVBC-41	HVBC-61	1	#4-1000 kcmil
HVBC-42	HVBC-62	2	#4-1000 kcmil
HVBC-43	HVBC-63	3	#4-1000 kcmil
HVBC-44	HVBC-64	4	#4-1000 kcmil

Accessory

BP-46	Fiberglass Bolt Pad (sleeve)
-------	------------------------------

ADDITIONAL PRODUCT INFORMATION

- Select the appropriate catalog number. Confirm selection with dimensions. One HVBC kit insulates one phase of an in-line cable-to-bus connection.
 - Maximum bolt length: 2 inches
 - Maximum busbar thickness: 5/8 inch
 - Maximum bare bus length: 9 inches
- BBIT tubing, BPTM tubing, or HVBT tape, can be used to insulate the exposed busbar before installing the HVBC products.
- Shielded cable must be terminated before installing the HVBC products; use TE's HVT terminations.
- Standard package: 3 kits/box
- Related test report: EDR-5103

BISG / BISG-24 Bus Isolation Squirrel Guard

FEATURES

- High voltage outdoor materials are used in the design
- Polymer is rugged, track resistant, UV-Stable, and ensures long-term performance regardless of environmental conditions
- Comes in red or gray colors
- Sizes range from two to five inches from the factory with "grill" design allowing for easy field modifications

APPLICATIONS

- TE's Raychem BISG is on installed substation equipment to protect animal caused outages.

BENEFITS

- ♦ The Isolation guard has reliably prevented animal-caused outages in electrical substation equipment for years
- ♦ Allow excellent visibility of switch blades and other components while providing resistance to power arcs and high winds
- ♦ Designed to allow one person to quickly and easily install with hot-sticks on vertical or horizontal mounted insulators

BISG-60/115-02



BISG-24



BISG-100/400



PRODUCT SELECTION INFORMATION: DIMENSIONS IN INCHES (MM)

Catalog Number	Insulator Core Diameter Range	Overall Product Diameter	Color	Installation
BISG-60/115-02(S10)	2.4-4.5 (60-115)	24	Red	De-energized
BISG-60/115-03-HOT (B10)	2.4-4.5 (60-115)	24	Red	Two stick (energized)
BISG-G-60/115-02(S10)	2.4-4.5 (60-115)	24	Gray	De-energized
BISG-G-60/115-03-HOT-B10	2.4-4.5 (60-115)	24	Gray	Two stick (energized)
BISG-24-01 (B10)	2.5-5.0 (62-125)	24	Red	One stick (energized)
BISG-G-24-01 (B10)	2.5-5.0 (62-125)	24	Gray	One stick (energized)
BISG-100/400 (B3)	1.50-4.50 (38-115)	16	Red	De-energized
BISG-G-100/400 (B3)	1.50-4.50 (38-115)	16	Gray	De-energized

ADDITIONAL PRODUCT INFORMATION

- Standard package: 10 BISG-60/115-02 | 10 BISG-24-01 assemblies per box. (one BISG will install on one insulator)
- Related test report: EDR-5310, EDR-5517-Bus Insulator Squirrel Guard (BISG-24-01)

BCAC Bushing Connection Animal Covers

FEATURES

- Specifically designed to prevent animal caused outages on bushing ranging from 15 to 35 kV
- Fast and easy installation
- Fit wide range of bushings and skirt diameters

APPLICATIONS

- TE's Raychem BCAC protects substation equipment from animal caused outages.

BENEFITS

- ♦ Preventing animal-caused outages for years
- ♦ Superior polymer provides long-term performance in all environments (material is rugged, non-tracking, and UV-Resistant)



PRODUCT SELECTION INFORMATION: DIMENSIONS IN INCHES (MM)

Catalog Number	Max Shed Diameter	Cover Height	Color
BCAC-5D/8-01(B12)	4.8 (122)	8.0 (203)	Red
BCAC-7D/10-01(B6)	6.8 (172)	10.5 (266)	Red
BCAC-8D/14-01(B6)	8.0 (203)	14.0 (355)	Red
BCAC-G-5D/8-01(B12)	4.8 (122)	8.0 (203)	Gray
BCAC-G-7D/10-01(B6)	6.8 (172)	10.5 (266)	Gray
BCAC-G-8D/14-01(B6)	8.0 (203)	14.0 (355)	Gray
BCAC-BYPASS-01(B1)*	6.8 (172)	10.6 (266)	Red
BCAC-BYPASS-02(B1)*	8.0 (203)	14.0 (355)	Red

* The BCAC covers are also kitted for voltage regulator applications. The kit includes two bushing covers and a center arrester cover.



ADDITIONAL PRODUCT INFORMATION

- Standard package: 12 or 6 units per box, depending on size of cover. (One BCAC will install on one insulator)
- Related Test Reports: EDR-5339, EDR-5407, UVR-8209

BCAC-IC Bushing Connection Inspection Substation Covers

FEATURES

- Visual inspection of connection and oil levels
- Conductors and leads exit easily through cover
- Robust latching and hinging mechanisms
- Reliable protection with enhanced features
- Good for coverage on equipment up to 35 kV

APPLICATIONS

- TE's Raychem BCAC-IC protects substation equipment from animal caused outages.

BENEFITS

- ♦ BCAC-IC Insulating covers prevent outages from all types of animals for years
- ♦ Fast and easy installation
- ♦ Top and side exits for conductor - no need to trim, therefore saving time



PRODUCT SELECTION INFORMATION: DIMENSIONS IN INCHES (MM)

Catalog Number	Standard Pack	Color	Insulator Core Range	Insulator Shed Range	Cover Size	
					Diameter	Height
BCAC-IC						
BCAC-IC-5D/6 (B6)	6	Red	1.5-3.5 (38-89)	2.5-5.0 (63-127)	5.00 (127)	6 (152)
BCAC-IC-7D/12 (B6)	6	Red	3.0-4.87 (76-124)	3.75-7.00 (95-178)	7.00 (178)	12 (305)
BCAC-IC-8D/18 (B6)	6	Red	3.5-6.25 (90-160)	4.00-8.00 (100-200)	8.00 (200)	18 (455)
BCAC-IC-10.5D/20 (B6)	6	Red	3.5-8.5 (90-215)	6-10.5 (150-267)	10.75 (273)	20 (508)
BCAC-G-IC-5D/6 (B6)	6	Gray	1.5-3.5 (38-89)	2.5-5.0 (63-127)	5.00 (127)	6 (152)
BCAC-G-IC-7D/12 (B6)	6	Gray	3.0-4.87 (76 24)	3.75-7.00 (95-178)	7.00 (178)	12 (305)
BCAC-G-IC-8D/18 (B6)	6	Gray	3.5-6.25 (90-160)	4.00-8.00 (100-200)	8.00 (200)	18 (455)
BCAC-G-IC-10.5D/20 (B6)	6	Gray	3.5-8.5 (90-215)	6-10.5 (150-267)	10.75 (273)	20 (508)

Catalog Number	Max Shed Diameter	Cover Height	Color
BCAC-IC-BYPASS			
BCAC-IC-BYPASS-01 (B1)	7.0 (178)	12.00 (305)	Red
BCAC-G-IC-BYPASS-01 (B1)	7.0 (178)	12.00 (305)	Gray

The BCAC covers are also kitted for voltage regulator applications. The kit includes two bushing covers and a center arrester cover.

ADDITIONAL PRODUCT INFORMATION

- Related test reports: EDR-5514, UVR-8209

BCIC Bushing Connection Insulating Covers

FEATURES

- Specifically designed to protect energized equipment conductors or busbars from flashovers from contact with birds, squirrels and other wildlife
- Variety of shapes and sizes protect a wide range of applications
- Excellent UV protection and track resistance

APPLICATIONS

- Substations
- Circuit breaker bushings
- Standoff insulators
- Capacitors
- Transformer bushings
- Voltage regulators
- Potential transformers

BENEFITS

- Long life span
- Installation can be done quickly in field by trimming entry and exit holes to required dimensions
- Can be re-entered for other maintenance needs and then reused, lowering overall lifetime costs

10

PRODUCT SELECTION INFORMATION: DIMENSIONS IN INCHES (MM)

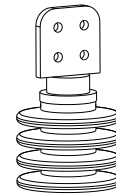
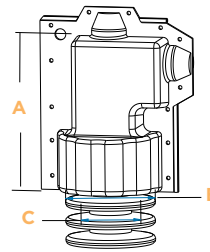

Catalog Number	Height (A)	Base Diameter (B)	Other Measurements (C)	Additional Notes
BCIC-4411 (B3)	10.6 (268)	6.0 (152)	4.0 (102) inner diam.	4 (100) Bottom port opening

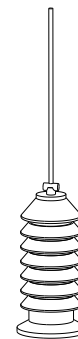
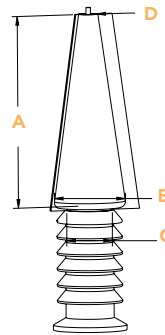

Catalog Number	Height (A)	Base Diameter (B)	Other Measurements (C)	Additional Notes
BCIC-SG-101-H2 (B3)	12 (305)	4.5 (114)	3 (72) inner diam.	(D) 1.125 (29) top diam. Bottom and top opening

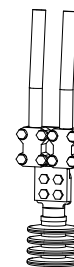
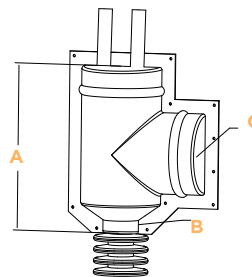

Catalog Number	Height (A)	Base Diameter (B)	Other Measurements (C)	Additional Notes
BCIC-9D/19-3 (B3)	18.5 (470)	4 (102)	9 (229) side diam.	

PRODUCT SELECTION INFORMATION: DIMENSIONS IN INCHES (MM)

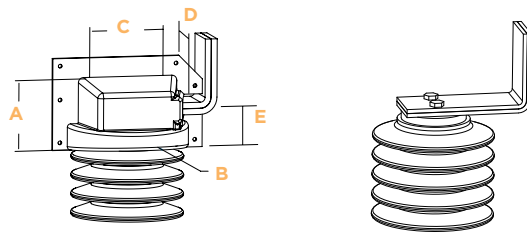

Catalog Number	Height (A)	Base Diameter (B)	Other Measurements (C)	Additional Notes
BCIC-8D/6-3 (B3)	4.7 (119.4)	8.0 (203.2)	5.00 (127) wide	(D) 5.40 (137.2) long, opening (E) 2.75 (69.9) from bottom

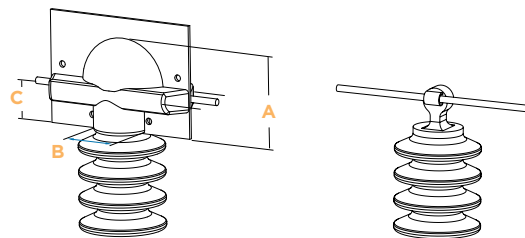
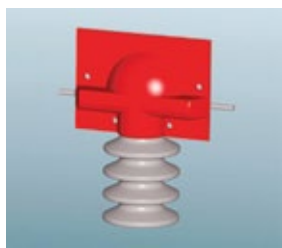

Catalog Number	Height (A)	Base Diameter (B)	Other Measurements (C)	Additional Notes
BCIC-3D/6-3 (B3)	3.5 (90.2)	2 (51)	1.5 (38) L. side diam.	2.0 (51) R. side opening 6.0 (152) width

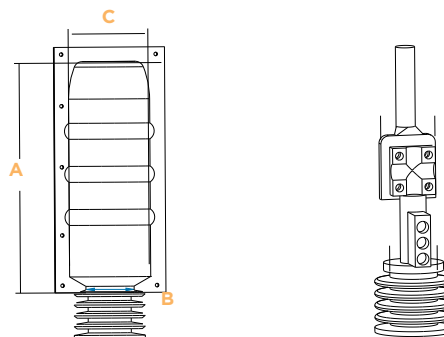

Catalog Number	Height (A)	Base Diameter (B)	Other Measurements (C)	Additional Notes
BCIC-5.5D/16-HO (B3)	17.1 (434)	3.2 (81)	5.5 (140) top diam.	

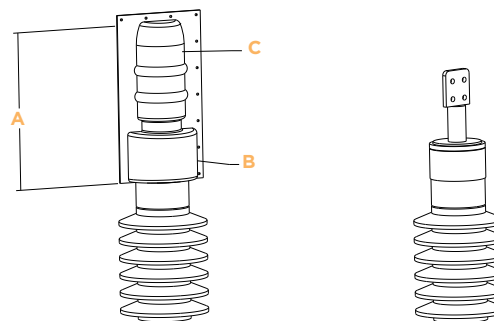

Catalog Number	Height (A)	Base Diameter (B)	Other Measurements (C)	Additional Notes
BCIC-8D/15-HO (B3)	16.2 (411)	8.0 (203.2)	5.5 (140) top diam.	4.5 (114) middle section diam., 12.5 height of section C.
BCIC-8D/18-HO (B3)	19.2 (488)	8.0 (203.2)	5.5 (140) top diam.	4.5 (114) middle section diam., 12.5 height of section C.

PRODUCT SELECTION INFORMATION: DIMENSIONS IN INCHES (MM)

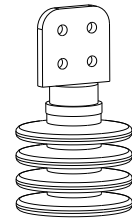
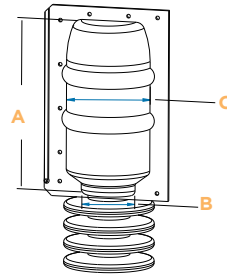

Catalog Number	Height (A)	Base Diameter (B)	Other Measurements (C)	Additional Notes
BCIC-5.5D/11-H0(B3)	11.5 (292)	3.50 (89)	5.50 (140) mid diam.	N/A

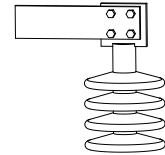
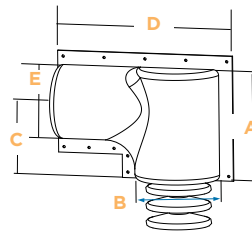

Catalog Number	Height (A)	Base Diameter (B)	Other Measurements (C)	Additional Notes
BCIC-10D/18-3 (B3)	14 (140)	9 (90)	7.75 (77.5)	(D)- 17.00 (E)- 8

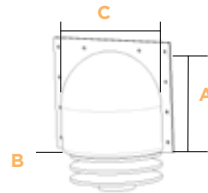

Catalog Number	Height (A)	Base Diameter (B)	Other Measurements (C)	Additional Notes
BCIC-8.25D/8	8 (80)	3 (30)	8.5 (85)	



Catalog Number	Height (A)	Base Diameter (B)	Other Measurements (C)	Additional Notes
BCIC-10D/18 (B3)	18 (457.2)	10 (254)	7.7 (195.58)	Bottom Port opening

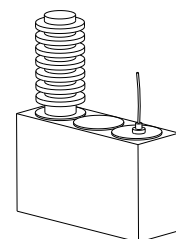
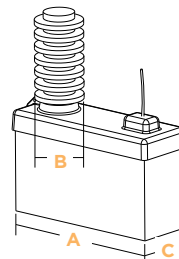
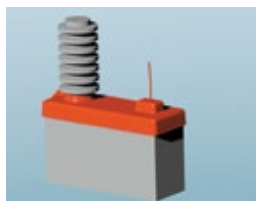

Catalog Number	(A)	Base Diameter (B)	Other Measurements (C)	Additional Notes
BCIC-0270-SCE (B3)	13.5 (135)	4.625 (117)	4.625 (46.25)	13.3 (338) length

10

PRODUCT SELECTION INFORMATION: DIMENSIONS IN INCHES (MM)

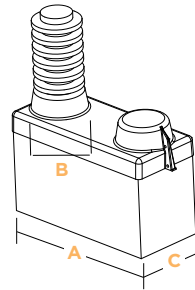
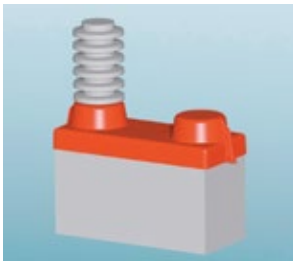

Catalog Number	(A)	Base Diameter (B)	Other Measurements (C)	Additional Notes
BCIC-0370-SCE (B3)	13.5 (mm)	3.63 (92)	5.875 (mm)	N/A

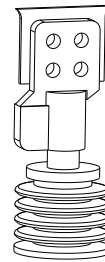
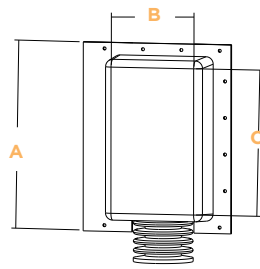

Catalog Number	Height (A)	Base Diameter (B)	Other Measurements (C)	Additional Notes
BCIC-12/12/5-H (B3)	12 (305)	12 (305)	5 (127)	N/A
BCIC-14/19/6-U (B3)	14 (356)	19 (483)	6 (142)	N/A
BCIC-24/11/12 (B3)	11 (279)	24 (610)	12 (304)	N/A
BCIC-4/12/4-H (B3)	4 (102)	12 (305)	4 (102)	N/A
BCIC-7/12/7-H (B3)	7 (178)	12 (305)	7 (178)	N/A
BCIC-4/16/4-H (B3)	4 (102)	16 (406)	4 (102)	N/A



Catalog Number	Height (A)	Base Diameter (B)	Other Measurements (C)	Additional Notes
BCIC-8D/6 (B3)	4.8 (121.92)	8 (203.2)	6.5 (165.1) wide	(D)- 5.00 Supplied in two halves with no pre cut openings

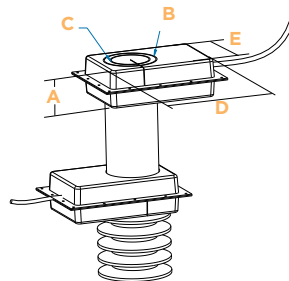
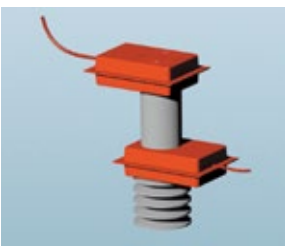

Catalog Number	Height (A)	Base Diameter (B)	Other Measurements (C)	Additional Notes
BCIC-8/12/2-U(B3)	4 (101)	5.75 (146.1)	4.25 (108) inner diam.	(D)- 12.0 (305) wide (E)- 8.0 (203) long

PRODUCT SELECTION INFORMATION: DIMENSIONS IN INCHES (MM)

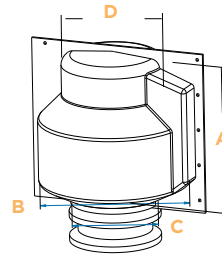

Catalog Number	Height (A)	Base Diameter (B)	Other Measurements (C)	Additional Notes
BCIC-13D/13-HO (B3)	13 (330)	13 (330)	7.5 (191) inner diam.	(D)- 8.8 (224) top diam.

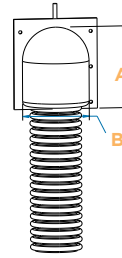

Catalog Number	Height (A)	Base Diameter (B)	Other Measurements (C)	Additional Notes
BCIC-5D/6 (B3)	6 (152)	5 (127)	N/A	N/A

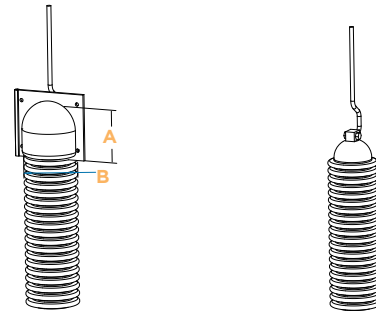

Catalog Number	Height (A)	Base Diameter (B)	Other Measurements (C)	Additional Notes
BCIC-4D/4 (B3)	4 (102)	4 (102)	N/A	N/A

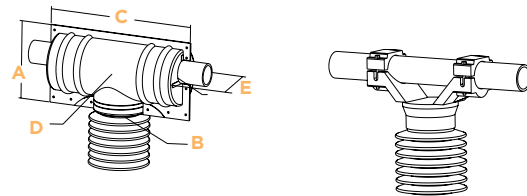

Catalog Number	Height (A)	Base Diameter (B)	Other Measurements (C)	Additional Notes
BCIC-7.5D/18-3 (B3)	10.4 (264)	4.5-6.75 (114-171)	20 (508) length	(D) 7.5 (191) L diam., (E) 2-4 (50-100) R diam.

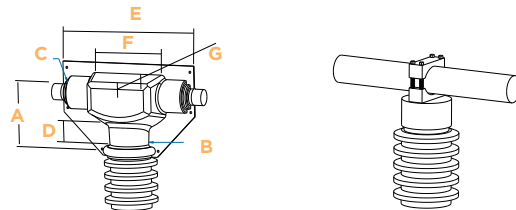

Catalog Number	Height (A)	Base Diameter (B)	Other Measurements (C)	Additional Notes
BCIC-SG-201-SCE(B3)	8.05 (204.5)	5.25 (133.4)	4.0 (102) Max side diam.	(D) 3.0 (76) base-joint height, (E) 17.5 (445) width (F) 8.25 (209.6) (G) 7.25 (184.2) depth

PRODUCT SELECTION INFORMATION: DIMENSIONS IN INCHES (MM)

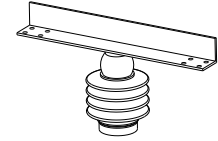
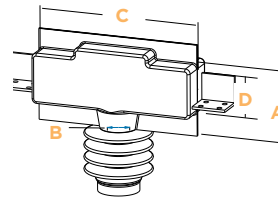
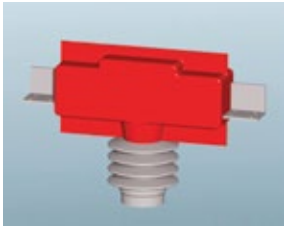

Catalog Number	Height (A)	Base Diameter (B)	Other Measurements (C)	Additional Notes
BCIC-TR205-L (B3)	7.5 (191)	2.25 (57)	17.0 (432) length	(D) 4.25 (108) side height

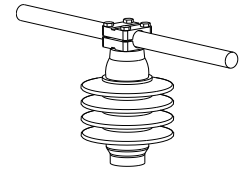
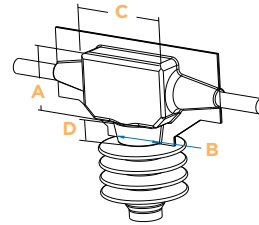

Catalog Number	Height (A)	Base Diameter (B)	Other Measurements (C)	Additional Notes
BCIC-TR205-R (B3)	5.5 (140)	4.5 (114)	8.0 (203)	(D) 2 (50) joint height

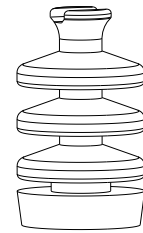
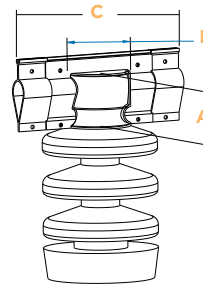
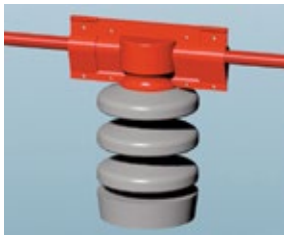

Catalog Number	Height (A)	Base Diameter (B)	Other Measurements (C)	Additional Notes
BCIC-3212-01 (B3)	3.5 (89)	4.125 (105)	12 (305) long	N/A

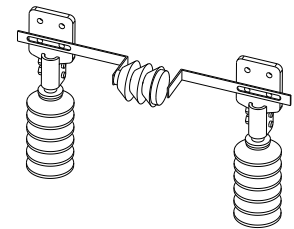
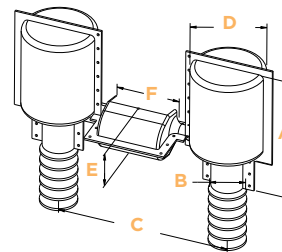

Catalog Number	Height (A)	Base Diameter (B)	Other Measurements (C)	Additional Notes
BCIC-BYPASS (B1)	13.75 (349.25)	3.75 (95.25)	19.00 (483) max distance	8.00 (203) top diam.,(D) 4.00 (102) connector diam., (E) 7.00 (178) (F) Design has two columns Connected with a cylinder

PRODUCT SELECTION INFORMATION: DIMENSIONS IN INCHES (MM)

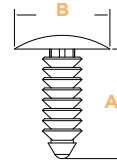

Catalog Number	Height (A)	Base Diameter (B)	Other Measurements (C)	Additional Notes
BCIC-LATCH (B250)	.800 (20.32)	.700 (17.78)	N/A	Std. Pack: 250 Latches or 1000 Latches

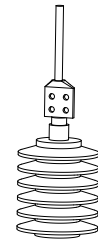
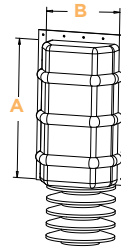

Catalog Number	Height (A)	Base Diameter (B)	Other Measurements (C)	Additional Notes
BCIC-11.5D/22(B3)	22 (559)	11.5 (292)	N/A	No pre trimmed openings

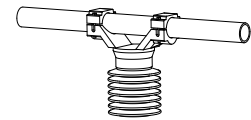
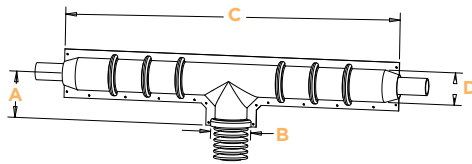

Catalog Number	Height (A)	Base Diameter (B)	Other Measurements (C)	Additional Notes
BCIC-5.5D/50	8 (200)	7 (178)	60 long (1524)	D- fits up to a 5.5" dia. bus

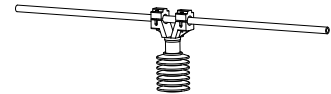
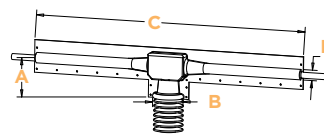

Catalog Number	Height (A)	Base Diameter (B)	Other Measurements (C)	Additional Notes
BCIC-5.5D/60(B3)	10.5 (267)	6.5 (165)	60 long (1524)	D- fits up to a 2" dia. bus

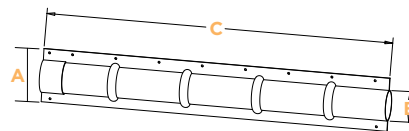

Catalog Number	Height (A)	Base Diameter (B)	Other Measurements (C)	Additional Notes
BCIC-G-4D/48-01(B4)	7.25 (184)	4 (101)	48 long (1219)	N/A

MVFT Medium Voltage Fusion Tape

FEATURES

- Self amalgamating
- Designed to combine the integrity of silicone polymer with the versatility of a wraparound product
- MVFT will stick to itself and other insulating materials, but will not adhere to metal or porcelain

APPLICATIONS

- TE's Raychem MVFT retrofit insulation of busbars
- Insulation when existing equipment can not be dismantled
- Suitable for indoor and outdoor use

BENEFITS

- ♦ Quick and easy to install
- ♦ Over-lapped layers amalgamate together, producing a complete seal
- ♦ A single layer of MVFT tape, two-thirds overlapped, will provide flashover protection to at least 15 kV and increases to 35 kV if second layer is added
- ♦ Selective sticking allows for easy removal for maintenance

MVFT



PRODUCT SELECTION INFORMATION

Catalog Number	Color	Width UOM: Inches (mm)	Length per Roll Feet (m)	Std. Pack
MVFT-G-2-12 (B4)	Gray	2 (50)	36 (11)	4 rolls

RECTANGULAR BUSBAR

Bus Width inches (mm)	Bus Length Insulated per Roll 2/3 Overlap feet (m)
1.0 (25)	8 (2.4)
2.0 (50)	4.7 (1.4)
3.0 (75)	3.1 (0.9)
4.0 (100)	2.3 (0.7)
6.0 (150)	1.4 (0.4)
8.0 (200)	0.4 (0.1)

ROUND BUSBAR

Bus Width inches (mm)	Bus Length Insulated per Roll 2/3 Overlap feet (m)
0.5 (12)	12.9 (3.9)
1.0 (25)	7.2 (2.2)
2.0 (50)	3.6 (1.1)
3.0 (75)	2.2 (0.7)
4.0 (100)	2.0 (0.6)

SQUARE BUSBAR

Bus Width inches (mm)	Bus Length Insulated per Roll 2/3 Overlap feet (m)
1x1 (25)	5.7 (1.7)
2x2 (50)	2.8 (0.8)
3x3 (75)	1.9 (0.6)
4x4 (100)	1.7 (0.5)

ADDITIONAL PRODUCT INFORMATION

- EDR-5465 Medium Voltage Fusion Tape Qualification Report

MVCC Medium Voltage Conductor Covers

FEATURES

- Made from non-tracking silicone material TE's Raychem MVCC is suitable for harsh medium voltage outdoor environments
- Covers are split for easy installation
- Four sizes available which fit conductor diameters ranging up to 1.75 inch

APPLICATIONS

- Substation
- Suitable for up to 25 kV phase to ground

BENEFITS

- ♦ Provide high quality electrical insulation for substation leads and jumpers
- ♦ Flexibility allows installation on tight bends
- ♦ Specifically designed to prevent flashover caused by contact with birds and animals



PRODUCT SELECTION INFORMATION

Catalog Number	Conductor Diameter Use Range UOM: inches (mm)	Color	Supplied Length UOM: feet (M)
MVCC-10/.40 (B100)	up to .450 (11)	Red	2 pieces at 50 (15.24)
MVCC-G-10/.40 (B100)	up to .450 (11)	Gray	2 pieces at 50 (15.24)
MVCC-19/.75 (B50)	0.50-0.75 (12-19)	Red	2 pieces at 25 (7.6)
MVCC-G-19/.75 (B50)	0.50-0.75 (12-19)	Gray	2 pieces at 25 (7.6)
MVCC-25/1.0 (B25)	0.75-1.125 (19-28)	Red	1 piece at 25 (7.6)
MVCC-G-25/1.0 (B25)	0.75-1.125 (19-28)	Gray	1 piece at 25 (7.6)
MVCC-45/1.75 x 4 (B24)	1.125-1.75 (28-44)	Red	6 pieces at 4 (1.2)
MVCC-G-45/1.75 x 4 (B24)	1.125-1.75 (28-44)	Gray	6 pieces at 4 (1.2)

ADDITIONAL PRODUCT INFORMATION

^a EDR-5461 Medium voltage Conductor Cover Electrical Testing and EDR-5498 Material test

BCIC-Angle Medium Voltage Conductor Cover

FEATURES

- Modular/ Wraparound product design
- Retrofit insulation on 3 to 4 inch angle busbars
- Insulation when existing equipment cannot be dismantled

APPLICATIONS

- TE's Raychem BCIC-Angle BUS Cover is suitable for indoor and outdoor use

BENEFITS

- ♦ Quick and easy to install
- ♦ Over-lapped sections together, produce increased bus bar coverage
- ♦ The BCIC angle bus cover will provide flashover protection up to 35 kV.



PRODUCT SELECTION INFORMATION

Catalog Number	Color	Busbar in (mm)	Supplied Length feet	Standard Pack pieces
BCIC-ANGLE-4X48 (B6)	Red	3-4 (75-100)	4	6
BCIC-G-ANGLE-4X48 (B6)	Gray	3-4 (75-100)	4	6

ADDITIONAL PRODUCT INFORMATION

- EDR-5594 BCIC-ANGLE-4X48 Electrical Testing

BCIC Raptor Protection Cover

FEATURES

- Reliable outage protection
- Fast and versatile installation
- High performance material
- Rugged, non-tracking, UV-resistant polymer
- Long-term performance in extreme conditions

APPLICATIONS

- TE's Raychem BCIC raptor protection covers protect overhead insulators to prevent outages caused by birds.

BENEFITS

- ♦ TE's Raychem BCIC insulating covers have a long history of successful outage prevention and these covers are designed to provide the same great protection with additional features
- ♦ Designed to nest over vibration dampers

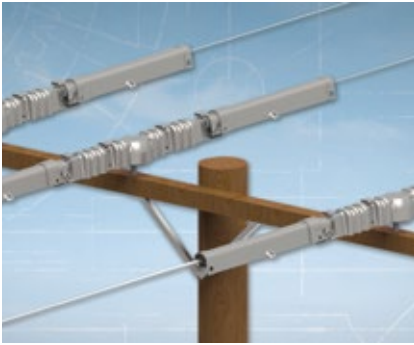

PRODUCT SELECTION INFORMATION

Catalog Number	Application	Conductor Range	Cover Length (in)	Type/ANSI	Standard Pack
BCIC-G-DPIN-795-01 (B6)	Double PIN Insulator	#6-795	41	55-5, 55-6, 55-7, 56-1, 56-2, 56-3	6
BCIC-G-DPIN-556-01 (B6)	Double PIN Insulator	#6-556	42	55-2, 55-3, 55-4, 55-5	6
BCIC-G-DSMPIN-795-01 (B6)	Double PIN Insulator	#6-795	42	55-5, 55-6, 55-7, 56-1, 56-2, 56-3	6
BCIC-G-HZ-795-XL (B6)	Horizontal Post	#6-795	29	Polymeric	6
BCIC-G-HZPOR/3.5D-795-01 (B6)	Horizontal Post	#6-795	29	Porcelain >35 kV	6
BCIC-G-HZPOR/4.5D-795-01 (B6)	Horizontal Post	#6-795	29	Porcelain 25 to 35 kV	6
BCIC-G-DE/CL-01 (B6)	Dead End	#6-795	27	Conductor	6

ADDITIONAL PRODUCT INFORMATION

- Related Test Reports: EDR-5562, EDR-5369

BCIC-GT Raptor Protection Cover

FEATURES

- Reliable outage protection
- Fast and versatile installation
- High performance material
- Rugged, non-tracking, UV-resistant polymer
- Long-term performance in extreme conditions

APPLICATIONS

- TE's Raychem BCIC-GT raptor protection covers protect overhead insulators to prevent outages caused by birds.

BENEFITS

- ♦ TE's Raychem BCIC-GT insulating covers have a long history of successful outage prevention and these covers are designed to provide the same great protection with additional features
- ♦ Up to 10 feet of coverage on conductor sizes ranging from #6 to 795 can be achieved when one cover and two arms are installed together
- ♦ Designed to nest over vibration dampers



BCIC-GT-PIN (B6)



BCIC-GT-PIN/CT (B6)

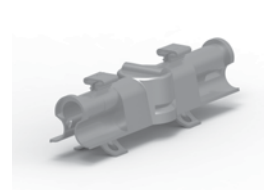

BCIC-GT-PIN/XL (B6)

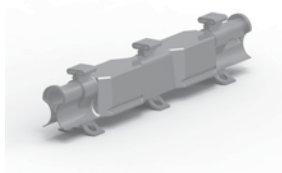

BCIC-GT-DPIN (B6)

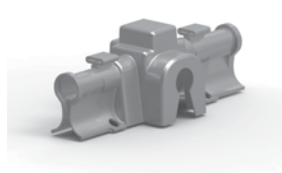

BCIC-GT-HZ (B6)



BCAC-G-ARM-01 (B12)

PRODUCT SELECTION INFORMATION

Description	Application	Range	Length (in)	Insulator Type/ANSI	Standard Pack
BCIC-GT-PIN (B6)	Porcelain Pin, Post	#6-795	20	55-4, 55-5, 57-2	6
BCIC-GT-PIN/CT (B6)	Vise Top	#6-795	20	Vise Top, Hendrix	6
BCIC-GT-PIN-XL (B6)	Porcelain Pin	#6-795	21	56-1, 55-6, 55-7	6
BCIC-GT-DPIN (B6)	Porcelain Pin, Post	#6-795	30.5	55-4, 55-5, 57-2	6
BCIC-GT-HZ (B6)	Horizontal Post	#6-795	21	Polymeric	6
BCAC-G-ARM-01 (B12)	Extension	#6-795	31	-	12

ADDITIONAL PRODUCT INFORMATION

- Related Test Report: EDR-5620 Salt Fog and Electrical Evaluation,
- EDR-5609 Raptor Cover Mechanical/Electrical Evaluation

BCAC Distribution Covers for Animal Protection

FEATURES

- TE's Raychem BCAC covers wide range of sizes
- Advanced polymers are rugged, track resistant, UV resistant

APPLICATIONS

- Terminations
- Reclosures
- Lightning arresters
- Fuse Cut-outs

BENEFITS

- ♦ Extensive testing has ensured that the cover will not damage or deteriorate the terminations
- ♦ Can be installed on energized equipment
- ♦ Secured to the stud and the conductor to insure protection even in high winds
- ♦ The BCAC-G-CUTOUT is hot-stickable and easily clips onto cutout insulators between first and second skirt

BCAC-AR-5D-2

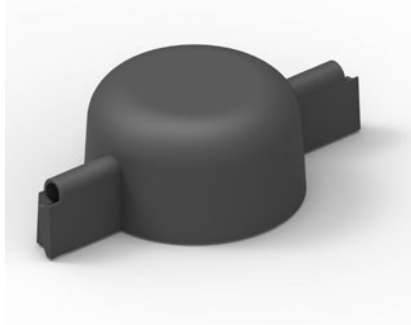

PRODUCT SELECTION INFORMATION

Catalog Number	Hardware
BCAC-P-IC-5D/6 (B6)	Transformer Bushing
BCAC-G-4D/13-2 (B18)	Terminations
BCAC-G-5D/8-01 (B12)	Transformer Bushing
BCAC-G-AR-5D-2 (B24)	Ohio Brass Arrester
BCAC-G-AR-4D-2 (B24)	TE Arrester
BCAC-G-AR-3.75D-2 (B24)	Cooper Arrester
BCAC-G-CUTOUT-100-01-B12	Fuse Cutout Switch (100 AMP) Porcelain style
BCAC-G-CUTOUT-100-P2-B12	100-AMP/Polymeric (Hubbel & Cooper style)
BCAC-G-CUTOUT-FT (B3)	Fuse Cutout Switch (200 AMP) Porcelain style
BCAC-G-CUTOUT-FT-P (B3)	Fuse Cutout Switch (200 AMP) Polymeric style



BCAC-4D/13-2



BCAC-P-IC-5D/6



BCAC-G-CUTOUT-100-01

ADDITIONAL PRODUCT INFORMATION

- Related test reports: EDR-5407 for Bushing covers, EDR-5569 for BCAC-P-IC, EDR-5571 for BCAC-AR, EDR-5573 for cutouts

BCIC Reclosers Recloser Covers

FEATURES

- One piece hinged design allows easy and quick installations
- Cover can be re-entered for maintenance needs and then reused
- Rated for up to 35kV

APPLICATIONS

- Reclosers

BENEFITS

- ♦ Other TE Raychem products can be purchased that insulate the leads and lightning arresters
- ♦ Years of reliable service and re-usable design lowers overall lifetime costs

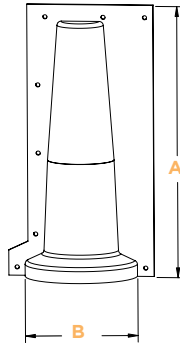

BCIC-G-Recloser-100 (B6)

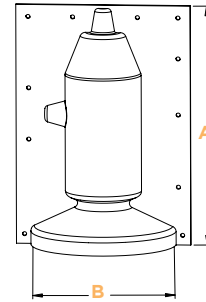

BCIC-G-Recloser-200 (B6)

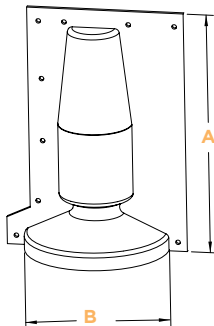

BCIC-G-Reclosercover (B6)

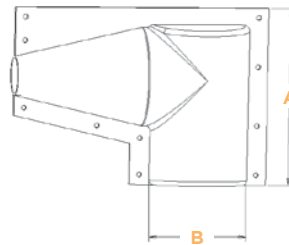

BCIC-5D/8/11 (B6)

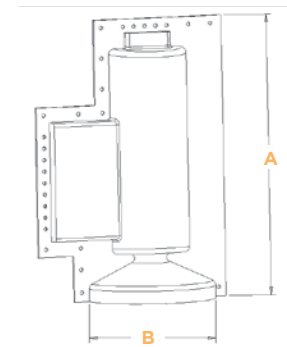

BCIC-Reclosure-200s (B6)

PRODUCT SELECTION INFORMATION: DIMENSIONS IN INCHES (MM)

Catalog Number	Color	Height (A)	Max Skirt (B)
BCIC-G-Reclosercover (B6)	Gray	12.4 (315)	7.8 (198)
BCIC-G-Recloser-100 (B30)	Gray	15.4 (390)	6.75 (171)
BCIC-G-Recloser-200 (B6)	Gray	14.5 (368)	8.5 (216)
BCIC-Reclosercover (B6)	Red	12.4 (315)	7.8 (198)
BCIC-Recloser-100 (B6)	Red	15.4 (390)	6.75 (171)
BCIC-Recloser-200S (B6)	Red	18.3 (465)	8.3 (211)
BCIC-G-Recloser-200S (B6)	Gray	18.3 (465)	8.3 (211)
BCIC-5D/8/11 (B6)	Red	9.0 (228)	4.8 (122)

MVLC Medium Voltage Line Cover

FEATURES

- Wrap-around cover
- Installation is possible on energized lines utilizing the MVLC tool which can be manually or automatically operated

APPLICATIONS

- Overhead conductors

BENEFITS

- ♦ Prevents electrical outages caused by incidental contact from tree branches or wildlife
- ♦ Can be applied selectively on problem spans to avoid costly conductor replacement



PRODUCT SELECTION INFORMATION: DIMENSIONS IN INCHES (MM)

Product Size	Conductor Size	Max. Conductor Dia.	Voltage Class
MVLC-14-A/U-C(100)	#6-3/0 kcmil	0.5 (12.7)	15 kV (sealing mastic in receptacle)
MVLC-14-A/241-C(100)	#6-3/0 kcmil	0.5 (12.7)	25 kV (sealing mastic in receptacle)
MVLC-18-A/U-C(75)	#2-397 kcmil	.75 (18)	15 kV (sealing mastic in receptacle)
MVLC-18-A/241-C(75)	#2-397 kcmil	.75 (18)	25 kV (sealing mastic in receptacle)
MVLC-38R-A/U-C (50)	#2-1590 kcmil	1.375 (35)	15 kV (sealing mastic in receptacle)
MVLC-38R-A/241-C (50)	#2-1590 kcmil	1.375 (35)	25 kV (sealing mastic in receptacle)

MVLC-14

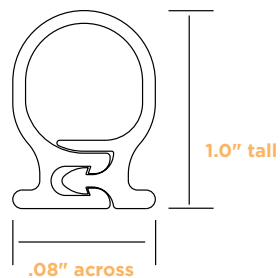

MVLC-18



MVLC-38R

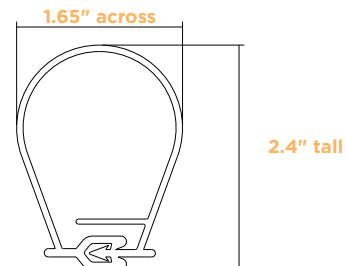

MVLC-Installation Tools for overhead conductors



MVLC-HAND-TOOL-14



MVLC-HAND-TOOL-02

10

Product Size	Conductor Size
MVLC-14-TOOL-100	for use with MVLC-14
MVLC-18-TOOL-03-2006	for use with MVLC-18
MVLC-38R-OHTOOL	for use with MVLC-38R
MVLC-HAND-TOOL-14	hand tool for installing MVLC-14
MVLC-HAND-TOOL-02	hand tool for installing MVLC-18
MVLC-38R-HAND TOOL	hand tool for installing MVLC-38R

ADDITIONAL PRODUCT INFORMATION

- Overhead Conductors: Standard package for MVLC-14 is 330 feet (100m) continuous on a spool. Standard package for MVLC-18 is 247 feet (75m) continuous on a spool.
- Related Test Reports: EDR-5308, EDR-5309, EDR-5316, EDR-5478
- MVLC TOOL contains the MVLC installation tool, MVLC cutters, drainage hole punch, hand crank, and a drive nut socket packaged in a protective bag
- MVLC can be installed at temperatures above 0°C (32°F)

PRODUCT PERFORMANCE

Test		MVLC-A/U / MVLC-A/241 (Sealed)	
AC withstand (dry) - 1minute		15 kV min / 25 kV min	
AC withstand (wet) - 1 minute		15 kV min / 25 kV min	
AC long term withstand (dry) - 4 hours		8.6 kV min / 14.4 kV min	
30 day thermal loading (8 hr at 130°; 16 hr off)		No MVLC deformation	
Conductor ampacity		82 - 89% of bare conductor ampacity	
Material Properties Per pps 3010/42		Test Method	Requirement
Physical	Tensile Strength Ultimate Elongation Abrasion Resistance Low Temperature Impact	ASTM D638 ASTM D638 1000 cycles, 2068g ASTM D746	8 Mpa min 1150 psi min 200% min 20% max thickness loss No Cracking at -20°C
Electrical	Dielectric Strength Tracking and Erosion Resistance	ASTM D149 ASTM D2303 Step Voltage Method (Initiate at 2.5 kV)	217 kV/cm @ 1.27 mm 550 V/mil min @ 0.050" No tracking or erosion to top surface or flame failure after: 200 minutes

BCIC-115-PH Transmission Flashover Protection Cover

FEATURES

- TE's Raychem BCIC-115-PH can be used on both porcelain disc and polymeric insulator designs
- Unique design allows the cover to rest on the lowest insulator for porcelain i-string designs
- Made from robust BCIS high-voltage material that is rugged, non-tracking, and UV-Resistant polymer

APPLICATIONS

- 115 kV transmission lines

BENEFITS

- Long-term performance even in the most extreme environmental conditions
- Can be used on energized or de-energized installations



PRODUCT SELECTION INFORMATION: DIMENSIONS IN INCHES (MM)

Catalog Number	Length	Height	Insulator Range	Applications
BCIC-115-PH (B1)	74 (1879.6)	15 (381)	9 12 (229-305)	Main cover
BCIC-Collar-50/280-5-B				Adapter collar for polymeric installations

BCIC-AFD-01 Avian Flight Diverter

FEATURES

- TE's Raychem BCIC-AFD-01 is designed to prevent bird collisions with power lines
- Incorporates high reflectivity and "glow-in-the-dark" appliques
- Easy to install, Hot-stickable, removeable
- Made from robust BCIC polymer that is rugged, non-tracking and UV resistant

APPLICATIONS

- Distribution and transmission lines

BENEFITS

- Long-term performance even in the most extreme environmental conditions
- Can be used on energized or de-energized installations



PRODUCT SELECTION INFORMATION: DIMENSIONS IN IN(MM)

Catalog Number	Description	Dimensions W x H	Conductor Size	Standard Pack
CU7208-000	BCIC-AFD-01 (B10)	4 x 3.5 (102 - 89)	#6-795	10

ADDITIONAL PRODUCT INFORMATION

- EDR-5536, Rev. A

HVCE High Voltage Creepage Extenders

FEATURES

- TE's Raychem HVCE high voltage creepage extenders are heat shrinkable
- Resistant to conventional spray washing techniques
- Will withstand most normal handling, abuse, and extreme weather conditions

APPLICATIONS

- Insulators

BENEFITS

- ♦ Increases the flashover performance of insulators by reducing the surface electrical stress and leakage current and increasing the electric strength of the insulators

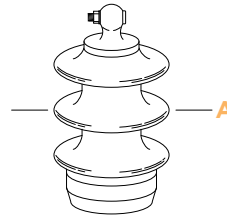

PRODUCT SELECTION INFORMATION: DIMENSIONS IN INCHES (MM)

Catalog Number	Skirt Diameter of Insulator (Min-Max) (A)	Minimum Internal Diameter of HVCE (as supplied)	Creepage Extension Per Extender (mm)	Standard Pack (pcs/box)
HVCE 100/80-01 (B-6)	3.20-3.90 (81-99)	4.50 (114)	101.6	6
HVCE 120/100-01 (B-6)	3.90-4.70 (99-119)	5.30 (135)	101.6	6
HVCE 140/120-01 (B-6)	4.70-5.50 (119-140)	6.10 (155)	101.6	6
HVCE 160/140-01 (B-6)	5.50-6.30 (140-160)	7.00 (178)	101.6	6
HVCE 183/161-01 (B-6)	6.30-7.20 (160-183)	8.00 (203)	101.6	6
HVCE 205/184-01 (B-6)	7.20-8.10 (183-206)	9.00 (229)	101.6	6
HVCE 226/206-11 (B3)	8.10-8.90 (206-226)	9.40 (239)	101.6	3
HVCE 247/227-11 (B3)	8.90-9.70 (226-246)	10.30 (262)	101.6	3
HVCE 268/248-11 (B3)	9.70-10.50 (246-267)	11.10 (282)	101.6	3
HVCE 289/269-11 (B3)	10.50-11.40 (267-290)	11.90 (302)	101.6	3
HVCE 310/290-11 (B3)	11.40-12.20 (290-310)	12.70 (323)	101.6	3
HVCE 331/311-11 (B3)	12.20-13.00 (310-330)	13.60 (345)	101.6	3
HVCE 352/332-11 (B3)	13.00-13.90 (330-353)	14.40 (366)	101.6	3
HVCE 373/353-11 (B3)	13.90-14.70 (353-373)	15.20 (386)	101.6	3
HVCE 394/374-11 (B3)	14.70-15.50 (373-393)	16.10 (409)	101.6	3

ADDITIONAL PRODUCT INFORMATION

- Select the appropriate catalog number. Confirm selection with insulator skirt outer diameter (A)
- Each HVCE extender adds a nominal 4 inches to the creepage length. As a general recommendation, TE advises a 20 percent increase in existing creepage distance. Use this formula to calculate the number of creepage extenders needed: Existing creepage distance in inches $\times 0.2 / 4 =$ Minimum number of HVCE creepage extenders recommended (i.e., 40 inches creepage $\times 0.2 / 4 = 2$ HVCE's). Always round up to a whole number (i.e., 1.33 to 2 HVCE's)
- For applications that do not fall within the ranges above, contact your local TE representative
- HVCE does not upgrade the voltage class of the insulator.
- Related test reports: UVR-8138, UVR-8144, UVR-8037, EDR-5350

HVCE-WA Wraparound High Voltage Creepage Extenders

FEATURES

- TE's Raychem HVCE-WA creepage extender has a wrap-around product design
- Adds six inches of creepage length

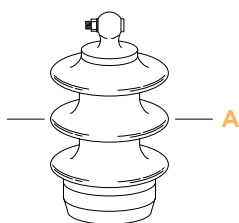

Example of a typical cross section of an HVCE with the dimensions representing that of the insulator profile

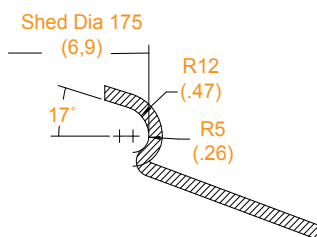

ADDITIONAL PRODUCT INFORMATION

- Each HVCE-WA Extender adds six inches to the creepage length. As a general recommendation, TE advises a 20 percent increase in existing creepage distance. Use this formula to calculate the number of creepage extenders needed:

Existing creepage distance in inches x 0.2 / 6 = Minimum number of HVCE creepage extenders recommended. (i.e., 60" x .2 / 6 = 2 HVCE-WAs needed). Always round up to a whole number (i.e., 1.33 - 2 HVCE's needed).

- HVCE does not upgrade the voltage class of the insulator
- Related Test Reports: UVR-8152, EDR-5350 Related Installation Instructions: HVCE-WA
- Installation Tool: HVCE-WA-TOOL
- For Applications that do not fall within the ranges above, contact your TE representative.

APPLICATIONS

- Insulators

BENEFITS

- Installs without having to disconnect equipment/conductors
- For use in highly contaminated applications

PRODUCT SELECTION INFORMATION: DIMENSIONS IN INCHES (MM)

Catalog Number	Shed Diameter of Insulator (A)	Standard Pack
HVCE-WA-175-02-FT (B6)	6.90 (175)	6
HVCE-WA-206-01 (B6)	8.11 (206)	6
HVCE-WA-216-01 (B6)	8.50 (216)	6
HVCE-WA-221-01 (B6)	8.70 (221)	6
HVCE-WA-226-01 (B6)	8.90 (226)	6
HVCE-WA-227-01 (B6)	8.94 (227)	6
HVCE-WA-234-01 (B6)	9.21 (234)	6
HVCE-WA-244-01-FT (B6)	9.61 (244)	6
HVCE-WA-248-01 (B6)	9.76 (248)	6
HVCE-WA-251-01 (B6)	9.88 (251)	6
HVCE-WA-255-01 (B6)	10.04 (255)	6
HVCE-WA-267-01 (B6)	10.51 (267)	6
HVCE-WA-271-01 (B6)	10.67 (271)	6
HVCE-WA-280-01-FT (B6)	11.02 (280)	6
HVCE-WA-281-01 (B6)	11.06 (281)	6
HVCE-WA-287-01 (B6)	11.30 (287)	6
HVCE-WA-292-01 (B6)	11.50 (292)	6
HVCE-WA-303-01 (B6)	11.93 (303)	6
HVCE-WA-323-01 (B6)	12.72 (323)	6
HVCE-WA-326-01 (B6)	12.83 (326)	6
HVCE-WA-330-01 (B3)	13.00 (330)	3
HVCE-WA-336-01 (B6)	13.23 (336)	6
HVCE-WA-341-01 (B6)	13.39 (341)	6
HVCE-WA-348-01 (B6)	13.70 (348)	6
HVCE-WA-349-01 (B6)	13.74 (349)	6
HVCE-WA-356-01 (B6)	14.02 (356)	6
HVCE-WA-359-01 (B6)	14.13 (359)	6
HVCE-WA-364-01 (B6)	14.33 (364)	6
HVCE-WA-367-01 (B6)	14.45 (367)	6
HVCE-WA-372-01 (B6)	14.65 (372)	6
HVCE-WA-373-01 (B6)	14.68 (373)	6
HVCE-WA-377-01 (B6)	14.84 (377)	6
HVCE-WA-381-01 (B6)	15.00 (381)	6
HVCE-WA-392-01 (B6)	15.43 (392)	6
HVCE-WA-393-01 (B6)	15.47 (393)	6
HVCE-WA-406-01 (B6)	15.98 (406)	6
HVCE-WA-407-01 (B6)	15.98 (407)	6
HVCE-WA-413-01 (B6)	16.26 (413)	6
HVCE-WA-421-01 (B6)	16.54 (421)	6
HVCE-WA-426-01 (B6)	16.77 (426)	6
HVCE-WA-429-01 (B6)	16.89 (429)	6
HVCE-WA-440-01 (B6)	17.32 (440)	6
HVCE-WA-442-01-FT (B6)	17.40 (442)	6
HVCE-WA-452-01 (B6)	17.60 (452)	6
HVCE-WA-457-01 (B6)	18.00 (457)	6
HVCE-WA-463-01 (B6)	18.23 (463)	6
HVCE-WA-482-01 (B3)	18.98 (482)	3
HVCE-WA-488-01 (B6)	19.21 (488)	6
HVCE-WA-490-01 (B6)	19.29 (490)	6
HVCE-WA-501-01 (B6)	19.72 (501)	6

HVBS High Voltage Booster Shed

FEATURES

- Spacers and short pegs which separate it from the porcelain skirt and insulator core
- TE's Raychem HVBS booster shed is a wrap around for rapid installation

APPLICATIONS

- Circuit breaker bushings
- Bus support insulators
- Surge arresters
- Transformer bushings

BENEFITS

- ♦ Prevents "Heavy Wetting" and ice-cascade-induced flashovers
- ♦ Made with advanced UV-resistant and anti-tracking polymer



PRODUCT SELECTION INFORMATION: DIMENSIONS IN INCHES (MM)

Catalog Number	Suitable Insulator Core	Medium Outside Insulator Skirt	Booster Shed Diameter Fully Installed
HVBS-770/310-01-M-BP	8.9-10.1 (227-257)	12.0 (304)	28.1 (713)
HVBS-740/280-01-M-BP	7.8-9.0 (199-229)	10.9 (276)	27.0 (685)
HVBS-710/250-01-M-BP	6.9-7.9 (175-201)	9.8 (249)	25.9 (657)
HVBS-685/225-01-M-BP	6.2-7.0 (158-178)	9.3 (235)	25.0 (634)
HVBS-665/205-01-M-BP	5.5-6.3 (140-160)	8.5 (216)	24.3 (616)
HVBS-615/155-01-M-BP	3.7-4.5 (94-114)	6.3 (161)	22.4 (569)

ADDITIONAL PRODUCT INFORMATION

- Related Test Report: UVR-8107 Qualification report for Booster Sheds
- Please contact your TE sales team for other available sizes.

RRGS Polymeric and Porcelain Rigid Red Guano Shield

FEATURES

- TE's Raychem RRGs is designed to fit both porcelain bells and polymeric insulators
- Two piece design allows for quick installation

APPLICATIONS

- Vertical insulator strings

BENEFITS

- ♦ Protects insulators from bird streamers



PRODUCT SELECTION INFORMATION: DIMENSIONS IN INCHES

Catalog Number	Insulator Type	Shield Diameter
RRGS-35/470-FT (B12)	Polymeric	18
RRGS-35/600-FT (B3)	Polymeric	24
RRGS-35/470-M (B12)	Porcelain	18
RRGS-35/600-M (B12)	Porcelain	24

Gray color also available

Protection, Repair and Maintenance

TE's Raychem Wildlife and Asset Protection product family offers easy-to-install busbar insulation systems for both the field engineer and the manufacturer. These electrical insulation products provide flashover protection against the accidental bridging of conductors commonly caused by birds and animals.

The system is ideal for both enclosed and exposed bus work and for connections in switchgear lineups, substations, and other electrical apparatus. It also permits clearance reduction in many applications.

Excellent Electrical and Thermal Performance

TE's Raychem Wildlife and Asset Protection products are manufactured from high dielectric strength, radiation-crosslinked, heat shrinkable materials. The high-voltage materials are specially formulated to provide high resistance to arcing and tracking. All high-voltage and low-voltage materials provide high-thermal endurance throughout the range of switchgear operating temperatures. They offer field-proven reliability and long service life in harsh environments. In addition, these heat shrink tubing, tape, and sheet products can be preformed and pre-shrunk in the customer's shop, allowing easy, quick installation in the field.

Compatibility with Other Insulating Materials

All Wildlife and Asset Protection heat shrinkable electrical insulation products are compatible with other solid switchgear insulating materials. Electrical insulating materials are not subject to stress crazing or embrittlement and are not adversely affected by common plasticizers used in conventional switchgear insulating materials.

Flame-retardant Materials

Most Wildlife and Asset Protection heat shrinkable electrical insulating materials pass the ANSI C37.20 switchgear insulation flammability tests.

Reduced Corrosive and Toxic Fumes

Wildlife and Asset Protection electrical insulation materials contain no chlorine compounds. This minimizes noxious and corrosive effects in case of equipment fault or fire.

For Protection, Repair, and Maintenance

Wildlife and Asset Protection heat shrinkable electrical insulating tubes, tapes, and sheets provide a complete system for electrical repair and maintenance of enclosed or exposed buswork and for connections in switchgear and electrical equipment. They offer:

- Fast, easy installation and removal
- A flexible system to cover most conductor shapes and sizes
- Consistent, reliable installation
- Consistent electrical and thermal performance
- Proven corrosion protection
- Compatibility with conventional solid insulating materials
- Protection against flashovers

For the Electrical Equipment Manufacturers

The Wildlife and Asset Protection system of insulation-enhancement components addresses the needs of electrical equipment manufacturers. The superior material properties and versatility of these components enhance the quality and reliability of the final product. Wildlife and Asset Protection electrical insulating materials feature.

- Low-hazard formulation
- Flexibility
- Track resistance
- Rugged, easy installation
- Excellent electrical and thermal performance
- Unlimited shelf life
- Corrosion protection of conductor
- TE assistance and support for testing and applications

Protection of Outdoor Equipment

TE's Raychem Wildlife and Asset Protection electrical insulation products provide a complete system of insulation enhancement for high-voltage busbars and related equipment in outdoor substations and overhead lines. The system offers:

- Easy installation in the field
- Insulation for many different shapes, including busbars, joints, tees, insulators/bushing connections
- Flashover protection against accidental bridging
- Protection of wildlife and from wildlife-induced outages
- Excellent UV and weathering resistance
- Protection against corrosion
- Protection against incidental tree branch contact

Protection of Medium Voltage Products

Material Properties	Test Method	Requirements	BBIT/BPTM	BCIC/HVIS	BCAC, HVCE-WA, HVBT	HVCE	MVLC	BISG/RRBB
Test and Performance								
Volume Resistivity	ASTM D-257, IEC 93	ohm-cm min	1.0 x 10 ¹³	1.0 x 10 ¹³	1.0 x 10 ¹³	1.0 x 10 ¹³	1.0 x 10 ¹³	1.0 x 10 ¹³
Dielectric Constant	ASTM D-150, IEC 250	Maximum	5	5	5	5	5	5
Dielectric Strength	ASTM D-149, IEC 243	V/mil at 1.3mm min V/mil at 1.5mm min V/mil at 2mm min V/mil at 2.5mm min V/mil at 3mm min	500 400	450 350	330	330	250	550
								V/mil at 2.5mm min: 380
Thermal								
Thermal Endurance	IEEE 1-1969, IEC 216	minimum	105°C	105°C	105°C**	110°C	105°C	
Accelerated Aging for 168 Hours	ISO 188	Tensile strength Ultimate elongation	1450 psi 300%	1450 psi 300%	1450 psi 300%	1100 psi 300%	1450 psi 100%	2450 psi 25%
		Aging Temperature	120°C	120°C	120°C	120°C	120°C	120°C
Chemical								
Flammability	ANSI C37.20	Pass	Pass	Pass	Pass			
Water Absorption	ISO/R 62, Procedure A	1% max after 14 days at 23°C	Pass	Pass	Pass	Pass	Pass	Pass
Low-Temperature Flexibility	ASTM D-2671, Procedure C	No cracking after 4 hours	Pass, -40°C	Pass, -40°C	Pass, -40°C	Pass, -40°C	Pass, -20°C	Pass, -40°C
Corrosion	Copper Mirror, ASTM D-2671, Procedure B	Passed visual inspection after 16 hours		Pass, 150°C	Pass, 150°C		Pass, 135°C	
Physical								
Tensile Strength	ASTM D-638, ISO 37	psi. (min)	1450 < 4mm 1150 > 4mm	1450	1450	1150	1450	2450
Ultimate Elongation	ASTM D-638, ISO 37	% minimum	300	300	300	300	200	25

NOTE : Blank spaces indicate that property was not measured during product qualification

*Each product's voltage rating will be displayed with its selection information

**Properties measured on backing material only. HVBT has a 90°C maximum continuous operating temperature limit

Bus Insulation Technical Data

TABLE BACKGROUND

This table indicates clearance differences for rectangular busbars without and with various wildlife and asset protection electrical insulation products. These spacings are derived from BIL, AC-withstand, DC-withstand, and discharge-extinction tests on a limited number of busbar configurations insulated with electrical insulation products.

Due to the wide range of possible busbar geometries, these spacings should not be adopted without actual testing by the user. Sharp electrodes and unusual geometries will require greater spacings.

Note: Phase-to-phase distances are reduced more than phase-to-ground distances because it is assumed that each phase is insulated

BUSBAR DATA INFORMATION: DIMENSIONS IN IN(MM)

System Voltage (kV)	BIL (kV)	Uninsulated Clearance (Indoor)		BBIT Clearance (Indoor)		BPTM, HVBT, and HVIS Clearance (Indoor)	
		A*	B**	A*	B**	A*	B**
15	95	7.5 (190)	5.0 (125)	2.2 (55)	2.6 (65)	3.4 (85)	4.2 (105)
25	125	10.5 (265)	7.5 (190)	2.8 (70)	4.0 (100)	4.5 (115)	6.0 (150)
35	150	12.5 (320)	9.5 (240)	5.6 (140)	7.5 (190)	6.5 (165)	8.0 (200)

* Phase-to-phase

** Phase-to-Ground

RECOMMENDED GUIDE SPECIFICATION

Please feel free to use the following in your design specification:

Insulation for energized bus components and connections shall consist of tubing, tape, and sheets that are factory-engineered to meet applicable switchgear performance requirements.

All insulation components shall be fabricated from flexible, cross-linked, heat-shrinkable polymeric materials formulated to provide high dielectric strength, adequate thermal endurance at bus operating temperatures, and tracking and erosion resistance.

The insulation materials shall contain no halogen compounds and be compatible without commercial, factory-installed bus insulation materials.

Materials shall be installable at temperatures as low as -40°F. Adhesive coatings on tape and sheet products shall not adhere to metal surfaces, thus permitting easy re-entry to the connections.

The insulation supplier shall furnish technical data to document design and performance to these requirements and functional testing of the complete insulation system in accordance with ANSI/IEEE C37.20.





Chapter 11 Accessories & Tools

Splicing Accessories	304
Termination Accessories	307
Conduit/Cable Sealing	309
Torches & Heat Guns	312
Cable Clamps.....	317
Tools	314

HV Ground Braid

FEATURES

- HV-Braid is a tinned copper braid



APPLICATIONS

- Solder-blocked for use with HVS and HVT kits

PRODUCT SELECTION INFORMATION: DIMENSIONS IN INCHES (MM)

Catalog Number	Braid Size (AWG)	Length of Moisture Blocked Braid	Standard Pack (pcs/box)
HV-BRAID-8-1520	#8	60 (1524)	3
HV-BRAID-6-1520	#6	60 (1524)	3
HV-BRAID-4-1520	#4	60 (1524)	3

Order shielding mesh based on braid size.

HVS-MESH Shielding Mesh

APPLICATIONS

- Used in conjunction with high-voltage ground braids

BENEFITS

- Provides shield continuity when splicing shielded power cable



PRODUCT SELECTION INFORMATION: DIMENSIONS IN INCHES (MM), FEET (M)

Catalog Number	Width	Length	Standard Pack (rolls/box)
HVS-MESH-2-5000	2 (51)	16 (4.8)	4

ADDITIONAL PRODUCT INFORMATION

- Order shielding mesh based on cable diameter and length of cable to be covered.
- To apply shielding mesh, half-lap around cable.

JGK-MS Rejacketing Sleeve

FEATURES

- Kits are RUS accepted and have been tested to meet the 10 kA/10 cycles or 15 kA/15 cycle fault current test requirements.
- Wraparound rejacketing sleeve has been water-seal tested to the applicable sections of ANSI C 119.1.

APPLICATIONS

- Each kit contains a constant-force ground clamp, a solder-blocked ground braid for external grounding, and a sealant to encapsulate and seal the ground connector.

BENEFITS

- Heat-shrinkable JGK-MS kits provide complete environmental sealing with a wraparound, adhesive-lined rejacketing sleeve
- JGK-MS kit addresses the RUS recommendation to externally ground the jacketed cable neutrals at least four times per mile to limit shield standing voltage, to avoid accidental shock, and to provide multiple parallel return paths for line-to-ground faults.



PRODUCT SELECTION INFORMATION: DIMENSIONS IN INCHES (MM)

Catalog Number	Nominal Use Range (AWG/kcmil)			Standard Pack (rolls/box)
	15 kV	25 kV	35 kV	
JGK-MS-1	#4-4/0	#1-1/0		10 kA, 10 cycles
JGK-MS-2	250-1000	1/0-750	1/0-500	15 kA, 15 cycles
JGK-MS-3	1000-2000	750-1750	500-1500	15 kA, 15 cycles

ADDITIONAL PRODUCT INFORMATION

- Standard package: 3 kits/box
- Related test report: EDR-5242

P63 Cable Preparation Kit

APPLICATIONS

- Can be used with all TE cable accessories.

BENEFITS

- Use P63 kits to clean and abrade cable insulation.



PRODUCT SELECTION INFORMATION

Catalog Number	Standard Pack (kits/box)
P63	12

ADDITIONAL PRODUCT INFORMATION

- One kit contains six solvent wipes, six dry wipes and three strips of abrasive paper.
- For splices, the number of prep kits vary depending upon size of cable and type of splice. For terminations, one prep kit will clean three phases (one 3/C termination or three 1/C terminations).
- Solvent wipes contain PT Technologies type PF cleaner.

HVS-GC Grounding Clamps

APPLICATIONS

- Used for securing ground braides when splicing or terminating power cables.



PRODUCT SELECTION INFORMATION: DIMENSIONS IN INCHES (MM)

Catalog Number	Use Range	Standard Pack (pcs/box)
HVS-GC-0.5	0.5-1.0 (13-25)	100
HVS-GC-1.0	1.0-2.0 (25-51)	100
HVS-GC-1.5	1.5-3.0 (38-76)	50
EPPA-034-A	0.5-0.8 (12-20)	
EPPA-034-E	0.7-1.1 (17-29)	
EPPA-034-F	1.2-1.5 (30-39)	
EPPA-034-G	1.6-2.4 (40-60)	
EPPA-034-H	2.0-3.0 (50-75)	
EPPA-034-L	2.3-3.3 (57-85)	

ADDITIONAL PRODUCT INFORMATION

- Order ground clamps based on cable diameter.
- Confirm size with use range.

HVS-LR

FEATURES

- Combines the strength and durability of TE's Raychem MBSM wraparound sleeve with an effective oil-resistant sealing mastic.

APPLICATIONS

- Offers a simple method of repairing lead sheath damage on paper-insulated, lead-covered (PILC) cables.

BENEFITS

- Tested to and meets the following load-cycling and pressure test requirements indicated in the chart below

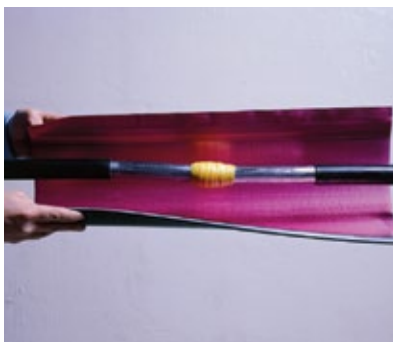

PRODUCT PERFORMANCE

Test	Result
Current cycling at 110°C conductor temperature for 90 cycles (5 hours on, 3 hours off)	Pass
Applied pressure	15 psi
Maximum continuous conductor temperature	110°C

PRODUCT SELECTION INFORMATION: DIMENSIONS IN INCHES (MM)

Catalog Number	Nominal Sleeve Length	Application Use Range (min - max)
HVS-LR-75/15-600	24 (600)	0.65-2.65 (17-67)
HVS-LR-75/15-1200	48 (1200)	0.65-2.65 (17-67)
HVS-LR-160/42-600	24 (600)	1.80-5.70 (46-144)
HVS-LR-160/42-1200	48 (1200)	1.80-5.70 (46-144)
HVS-LR-200/50-600	24 (600)	2.15-7.10 (55-180)
HVS-LR-200/50-1200	48 (1200)	2.15-7.10 (55-180)

ADDITIONAL PRODUCT INFORMATION

- Be sure to look at both the cable jacket diameter and the lead sheath diameter when selecting the HVS-LR kit.
- Standard package: 3 kits/box
- Related test report: EDR-5243

BRKT-SS Cable Mounting Brackets

FEATURES

- The brackets are constructed of stainless steel and include all hardware.
- Includes a mounting bracket and rubber pad.

APPLICATIONS

- Suitable for use on all types of cables
- For use with terminations or other applications where cable mounts are needed.

BENEFITS

- ♦ BRKT-SS cable mounting brackets are versatile and may be used outdoors.



PRODUCT SELECTION INFORMATION: DIMENSIONS IN INCHES (MM)

Catalog Number		Cable Range O.D. Range
90°	Straight	
BRKT-1-SS	BRKT-1-SS-SPCL	0.80-1.25 (20-32)
BRKT-2-SS	BRKT-2-SS-SPCL	1.10-1.50 (28-38)
BRKT-3-SS	BRKT-3-SS-SPCL	1.45-1.95 (37-50)
BRKT-4-SS	BRKT-4-SS-SPCL	1.80-2.40 (46-61)

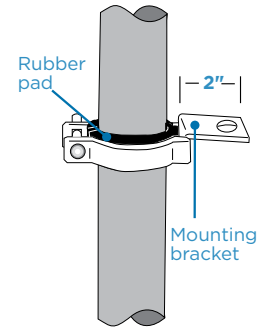

ADDITIONAL PRODUCT INFORMATION

- Standard package: 1 bracket/box
- Order brackets based on cable diameter, confirm size with use range.
- Related test report: NCTR-99-065

EAKT-1520 Mounting Kits

FEATURES

- Includes a galvanized steel T-bracket, three insulators for poletop mounting, and installation instructions.
- The insulators are lightweight and shatterproof. They combine a strong and flexible polymeric core with TE's proven high-voltage, nontracking material.

APPLICATIONS

- Offers a mounting bracket and support insulators for poletop mounting of TE high voltage terminations
- Used with TE's Raychem high-voltage outdoor termination kits (15-35 kV).

BENEFITS

- ♦ The bracket is dip galvanized to meet outdoor requirements (BS 729)

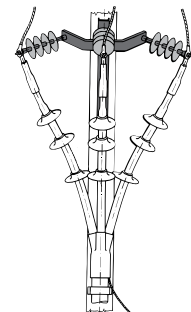
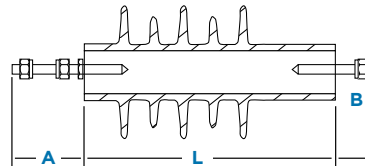
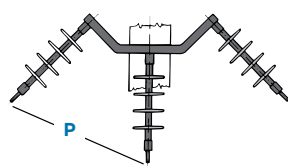

PRODUCT SELECTION INFORMATION: DIMENSIONS IN INCHES (MM)

Catalog Number	Voltage Class (kV)	Insulator Dimensions				No. of Skirts	Min Creepage Length	Mechanical Capabilities Cantilever	Torque M12 (ft. lb)
		P	L	A	B				
EAKT 1521	15	12.5 (310)	7.6 (195)	2.6 (65)	1.4 (35)	5	15.4 (390)	184	37
EAKT 1523	25	17.0 (430)	12.0 (305)	2.6 (65)	1.4 (35)	9	26.0 (660)	184	37
EAKT 1524	35	22.0 (560)	15.0 (380)	2.6 (65)	1.4 (35)	11	43.3 (1100)	516	37

ADDITIONAL PRODUCT INFORMATION

- Standard package: 1 kit/box.
- Related test reports: UVR-8150, UVR-8166

MOD-S Skirts

APPLICATIONS

- Used with TE's Raychem high voltage termination kits for outdoor applications.



PRODUCT SELECTION INFORMATION: DIMENSIONS IN INCHES (MM)

Catalog Number	Cable Insulation Diameter (min-max)	Std. Pack (skirts/box)
MOD-S1-314-Skirts	0.35-0.55 (9-14)	6
MOD-S2-325-Skirts	0.60-1.25 (15-32)	6
MOD-S3-336-Skirts	0.85-1.75 (22-44)	6
MOD-S4-346-Skirts	1.15-2.45 (29-62)	6
MOD-S5-357-Skirts	2.00-3.30 (50-84)	6

ADDITIONAL PRODUCT INFORMATION

- TE outdoor termination kits (-S) include appropriate number of skirts for the particular voltage.
- See the table below for the number of skirts needed at each voltage.

Voltage	HVT Number of Skirts	HVT-Z Number of Skirts
5-8 kV	1	0
15 kV	2	1
25 kV	3	4
35 kV	4	4

RDSS Duct Sealing System

FEATURES

- Consists of an inflatable, sealed bladder of flexible, metallic laminate material, which has pre-installed, high-temperature sealant strips on both sides.
- The bladder is first inflated to 45 psi (three-bar) internal pressure, and then presses the sealant against the duct wall and onto the substrate.
- The bag uses a self-sealing gel material to seal the filling hole when the filling tube is removed

APPLICATIONS

- Designed for use in conjunction with plastic, concrete, or steel ducts to provide a watertight duct seal.
- Seals cable ducts and helps to prevent flooding in cable vaults, access manholes, substation basements, and customer feeds. It can be installed while the water is flowing—see photograph.

BENEFITS

- For applications with three or more cables, an RDSS-CLIP is inserted between the cables.
- The RDSS-CLIP is a high-temperature mastic mounted on an installation stick. It seals the area between the cables when used in conjunction with the RDSS inflatable bladder.
- Acceptable to use on medium voltage cables including unjacketed concentric neutral.

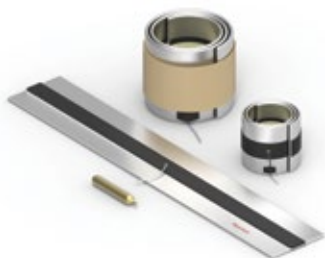

PRODUCT SELECTION INFORMATION: DIMENSIONS IN INCHES (MM)

Duct Inner Diameter	Number of Cables in Duct/ Max Cable Bundle Diameter					
	0, 1, or 2 Cables		3 or 4 Cables		5, 6, 7 Cables	
1.25 (32)	RDSS-45	0.5 (13)	RDSS-45, 1 RDSS-CLIP-45	0.3 (8)	RDSS-45, 2 RDSS-CLIP-45	0.1 (3)
1.50 (38)	RDSS-45	1.0 (25)	RDSS-45, 1 RDSS-CLIP-45	0.8 (20)	RDSS-45, 2 RDSS-CLIP-45	0.6 (15)
1.75 (45)	RDSS-45	1.3 (32)	RDSS-45, 1 RDSS-CLIP-45	1.05 (27)	RDSS-45, 2 RDSS-CLIP-45	0.9 (22)
2.00 (50)	RDSS-60	1.2 (30)	RDSS-60, 1 RDSS-CLIP-75	1.0 (25)	RDSS-60, 2 RDSS-CLIP-75	0.8 (20)
2.25 (57)	RDSS-60	1.6 (41)	RDSS-75, 1 RDSS-CLIP-75	1.4 (36)	RDSS-75, 2 RDSS-CLIP-75	1.2 (31)
2.50 (64)	RDSS-75	1.5 (38)	RDSS-75, 1 RDSS-CLIP-75	1.3 (33)	RDSS-75, 2 RDSS-CLIP-75	1.1 (28)
2.75 (70)	RDSS-75	1.8 (46)	RDSS-75, 1 RDSS-CLIP-75	1.6 (41)	RDSS-75, 2 RDSS-CLIP-75	1.4 (36)
3.00 (75)	RDSS-75	2.2 (56)	RDSS-75, 1 RDSS-CLIP-75	2.0 (50)	RDSS-75, 2 RDSS-CLIP-75	1.8 (46)
3.25 (83)	RDSS-100	2.2 (56)	RDSS-100, 1 RDSS-CLIP-100	2.0 (50)	RDSS-100, 2 RDSS-CLIP-100	1.8 (46)
3.50 (89)	RDSS-100	2.6 (66)	RDSS-100, 1 RDSS-CLIP-100	2.4 (61)	RDSS-100, 2 RDSS-CLIP-100	2.2 (56)
3.75 (95)	RDSS-100	2.9 (74)	RDSS-100, 1 RDSS-CLIP-100	2.7 (69)	RDSS-100, 2 RDSS-CLIP-100	2.5 (64)
4.00 (100)	RDSS-100	3.2 (80)	RDSS-100, 1 RDSS-CLIP-100	3.0 (75)	RDSS-100, 2 RDSS-CLIP-100	2.8 (70)
4.25 (108)	RDSS-100	3.5 (89)	RDSS-100, 1 RDSS-CLIP-100	3.3 (85)	RDSS-100, 2 RDSS-CLIP-100	3.1 (79)
4.50 (114)	RDSS-100	3.5 (89)	RDSS-100, 1 RDSS-CLIP-100	3.3 (85)	RDSS-100, 2 RDSS-CLIP-100	3.1 (79)
4.75 (121)	RDSS-125	3.8 (97)	RDSS-125, 1 RDSS-CLIP-125	3.6 (92)	RDSS-125, 2 RDSS-CLIP-125	3.4 (87)
5.00 (125)	RDSS-125	4.1 (104)	RDSS-125, 1 RDSS-CLIP-125	3.9 (98)	RDSS-125, 2 RDSS-CLIP-125	3.7 (93)
5.25 (133)	RDSS-150 [†]	4.3 (109)	RDSS-150 [†] , 1 RDSS-CLIP-150	4.1 (104)	RDSS-150 [†] , 2 RDSS-CLIP-150	3.9 (98)
5.50 (140)	RDSS-150 [†]	4.7 (120)	RDSS-150 [†] , 1 RDSS-CLIP-150	4.5 (114)	RDSS-150 [†] , 2 RDSS-CLIP-150	4.3 (109)
5.75 (146)	RDSS-150 [†]	4.9 (124)	RDSS-150 [†] , 1 RDSS-CLIP-150	4.7 (119)	RDSS-150 [†] , 2 RDSS-CLIP-150	4.5 (114)
6.00 (150)	RDSS-150 [†]	5.1 (129)	RDSS-150 [†] , 1 RDSS-CLIP-150	4.9 (124)	RDSS-150 [†] , 2 RDSS-CLIP-150	4.7 (120)
6.25 (159)	RDSS-150 [†]	5.4 (138)	RDSS-150 [†] , 1 RDSS-CLIP-150	5.2 (133)	RDSS-150 [†] , 2 RDSS-CLIP-150	5.0 (125)

6.50-8.00 (165-210) Ducts in this range require the use of RDSS-AD-210 adapter. Contact your TE representative for application information.

[†]See Ordering information.

ADDITIONAL PRODUCT INFORMATION

- In ducts where the cable/cable bundle is less than 2.4" (60mm) in diameter, an RDSS-AT/AP-150 device must be used in conjunction with the RDSS-150.
- Standard package: RDSS = 10 kits/box or 3 kits/box
RDSS-CLIP = 5 clips/box
RDSS-TOOLS = 1 each/box, CO2 cartridges = 10 each/box,
RDSS-AT/AP-150 = 1 each/box

- Related test report: EDR-5253
- S-1278 sealant, used in RDSS-CLIPS, is available separately.
- For proper inflation do not exceed the maximum cable bundle diameter (MCBD). To determine MCBD, use a diameter tape or contact your TE representative for assistance.

RDSS SEALING CLIP

RDSS duct sealing clips are to be used if the duct is occupied by more than two cables. The maximum number of cables sealed with one RDSS-CLIP is four. If more cables are to be sealed, one extra clip is needed for every three additional cables. Check with your TE Connectivity representative for applications with more than seven cables.

Catalog Number	Kit Used With
RDSS-CLIP-45	RDSS-45
RDSS-CLIP-75	RDSS-75 and RDSS-60
RDSS-CLIP-100	RDSS-100
RDSS-CLIP-125	RDSS-125
RDSS-CLIP-150	RDSS-150

RDSS INSTALLATION TOOLS

RDSS duct seals can be installed with a variety of inflation tools having the capability of inflating RDSS to 45±3 psi (3 bar) of pressure. The tools TE offers are summarized in the table below. The tool will only accept 16-gr CO2 gas cylinders (listed below).

Catalog Number	Description	Standard Pack
RDSS-IT-16	Inflation tool designed with an ON/OFF switch and an automatic pressure-monitoring system. The required CO2 gas cylinders (E7512-0160) must be ordered separately.	1 tool/box
E7512-0160	16-gr CO2 gas cylinders for the RDSS-IT-16 tool. Each gas cylinder inflates approximately four RDSS-100 duct seals.	10 cylinders/box
E7512-0220	Tube snap assembly. Spare part for RDSS-IT-16 inflation tool.	1 each/box
E7512-0240	Spare pressure gauge assembly for RDSS-IT-16 inflation tool.	1 each/box
E7512-0260	Spare delivery pipe for RDSS-IT-16 inflation tool.	1 each box
S-1278-3 x 61 x 7620	RDSS sealant roll (for smaller diameter wires)	1 25-ft roll/box
RDSS-AT/AP-150	For use with the RDSS-150 in duct 5.25" or larger 1 each/box with cable/cable bundles less than 2.4" (60 mm) in diameter.	1 each/box
RDSS-AD-210	Adapter for ducts 6.5 - 8.0" (165 - 210 mm) diameter.	4 each/box
E4540-1250	RDSS-LUBE for installation of RDSS.	25 each/box

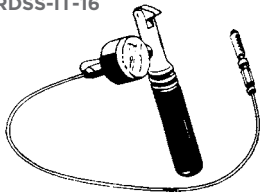
RDSS-IT-16

Blank Duct Plug / Sealing Ducts

FEATURES

- All plastic construction
- Corrosion proof
- Water and gas tight
- Easy Installation and removal
- Fully removable and reusable
- Each blank plug is equipped with a rope tie mechanism that provides the benefit of securing a pull rope to plug back compression plate and the allowance of storing excess slack rope behind the plug within the conduit system for future use.

APPLICATIONS

- Effectively seal empty conduits to reduce the cost of cable placement and maintenance in new underground construction projects and routine work.

BENEFITS

- ♦ Plugs are removable and reusable providing a more economical sealing solution
- ♦ These plugs prevent the flow of water and the costly sedimentation of duct banks and conduit systems while confining problems of dangerous vapors to their source.
- ♦ Manufactured from high-impact plastic components, combined with durable elastic gaskets, blank plugs are corrosion proof and effective for long-term or temporary sealing.



PRODUCT SELECTION INFORMATION: DIMENSIONS IN INCHES (MM)

Catalog Number	Plug Diameter	Duct ID	Standard Pack
RBDP-BLA-10D104U	1	0.96-1.16 (24.4-29.5)	12
RBDP-BLA-12D148U	1.25	1.14-1.48 (29.0-37.6)	12
RBDP-BLA-15D183U	1.5	1.49-1.83 (37.8-46.5)	12
RBDP-BLA-20D236U	2	1.83-2.36 (46.5-59.9)	12
RBDP-BLA-25D2964	2.5	2.34-2.96 (59.4-75.2)	12
RBDP-BLA-30D346U	3	2.99-3.46 (75.9-87.9)	12
RBDP-BLA-40D402U	4	3.94-4.17 (100.0-105.9)	8
RBDP-BLA-50D500U	5	4.58-5.02 (116.3-127.5)	8
RBDP-BLA-50D535U	5	5.00-5.35 (127.0-135.9)	8
RBDP-BLA-60D637U	6	5.82-6.37 (147.8-161.8)	8
RBDP-BLA-80D816U	8	7.83-8.27 (198.9-210.1)	8

Torches

These clean-burning, efficient, heat shrinking torches are recommended for shrinking high voltage products through low voltage products.



Primus-Sievert Siever-Matic Torch Materials

FH-3366-97-HANDLE

- Siever-Matic S auto ignite, auto shut-off torch handle
- Ergonomic design ensures comfortable operation
- Adjustable output
- Piezo ignition



FH-AD-3061-23-PS-REGULATOR

- Works with torch handle FH-3366-97-PS-HANDLE above
- Adjustable from 14-57psi
- Fitting POL, UNF 9/16 inch LH
- Requires torch hose AD-1432 or AD-1434



FH-AD-3347-91-PS-BURN-1

- Works with torch handle FH-3366-97-PS-HANDLE above
- Recommended especially for low voltage and general purpose products
- Tip diameter 1.0 inch 20,000BTU/hour



FH-AD-3341-47-PS-BURN1.5

- Works with torch handle FH-3366-97-PS-HANDLE above
- Recommended especially for low voltage products and high voltage terminations and splices
- Tip diameter 1.5 inch 40,000BTU/hour



FH-AD-3348-91-PS-BURN-2

- Works with torch handle FH-3366-97-PS-HANDLE above
- Recommended especially for Raysulate products
- Tip diameter 2.0 inch 90,000BTU/hour

Torch Accessories



AD-1358-LPG-REGW/GAGE

- Propane tank regulator with gauge (0–30 psi)
- Can also be used with Primus-Sievert or BullFinch products



AD-1432-ACD10FT-LPG-HOSE

- 10-foot LPG hose

AD-1434-ACD30FT-LPG-HOSE

- 30-foot LPG hose



AD-1460-ACD-HEAT-SHLDGPA

- 12 x 40 pad woven of heat-resistant fabric with corner grommets
- Protects adjacent components from torch heat during installation of heat-shrinkable products in confined areas

AD-1563-ACD-ADAPTER

- Valve to standard hose
- For use with FH-2618A-1 propane torch if disposable cylinders are not used

AD-3015-04

- Adapts Siever-Matic S FH-2649-PS-KIT or FH2629 for use with disposable 14.1 oz propane cylinders
- Includes 4-foot hose and regulator preset at 28 psi

Torch Kits



FH-2618A-1

- Light, portable propane torch for installing low voltage products and smaller, conductor-sized, high-voltage (up to 15 kV) accessories
- Includes hose, handle assembly, and regulator for disposable propane cylinder
- Operates from disposable 14.1 oz. propane cylinders
- Output: Approximately 20,000 BTU/hour
- Handle and torch head not available separately
- Regulator and hose assembly is product AD-3015-04

FH-2629-Kit

- Includes (AD-1432) 10 foot hose, (AD-1358) adjustable regulator, and (FH-2629-TORCH-ASSY) torch handle and tip



FH-2640-PS-KIT

- Primus-Sievert torch kit for use with disposable propane bottles
- Includes (FH-3366-97-PS-HANDLE, FH-AD-3341-91-PS-BURN1.5, & AD-3015-04)

FH-2649-PS-KIT

- Seiver-Matic S auto ignite, auto shut-off torch system
- Recommended especially for Raysulate products and can be used with all products
- Includes ergonomic handle, 30 foot hose, adjustable regulator, and large burner (3348-91); all in a canvas carrying bag
- Output: Approximately 90,000 BTU/hour
- Smaller burner and adapter for disposable bottles available. Includes: FH-3366-97-PS-HANDLE, FH-AD-3348-91-PS-BURN-2, FH-AD-3061-13-PS-REGULAT, AD-1434-ACD30FT-LPG-HOSE, and a carrying bag

Splicing Tools



EXRM-1004-US - Insulation Removal Tool

- Description - hand tool for making ring cuts on cable jackets and EPR insulation.
- Length = 7.5 inches
- Ring cut range - .50-2.00 inches



EXRM-0607 - Cable Splice Knife

- Special purpose short blade
- Comfortable full-size handle
- Finest cutlery steel, tough and carefully tempered to hold its edge

Impact Wrench



Ordering Information

Catalog Number T25446-000

Impact Wrench Accessories

Catalog Number J68898-000

Cable Cutters



1490489-1

- Suitable for copper or aluminum, solid or stranded to 350 MCM
- Ratchet mechanism keeps handle force low
- Handles lock together for safety/storage
- Compact design for easy fit into tight places
- Quick-release lever for easy take-up
- Ideal for cutting cable up to 2/0
- Also cuts coax cable up to RG-9



607453-2 1

- Great for copper and aluminum cable up to 1.5" diameter
- Light weight tubular steel handles with vinyl hand grips
- Fixed and moving blade made from high grade alloy steel
- Fast advance button to minimize required motion
- Combines light weight and ratcheted mechanical advantage in its circular cutting motion
- Weight 3.27 Lb [1.49 Kg]
- Not for steel or ACSR cable



169415-1

- Solid and stranded copper and aluminium cables
- Solid Cu 185 mm²
- Solid Al 240 mm²
- Stranded Cu / Al Ø25
- Hi Flex Cu Ø32

734045-1

- Solid and stranded copper and aluminium cables
- Solid Cu 185 mm²
- Solid Al 185 mm²
- Stranded Cu / Al Ø52
- Hi Flex Cu Ø52



1-1579002-8

- Solid and stranded copper and aluminium cables (no ACSR)
- Solid Cu 480 mm²
- Solid Al 480 mm²
- Stranded Cu / Al Ø54

KMS-K-INT

- Cable Sheath cutter

Cable Vise



IT 1000-002

The IT-1000-002 cable vise is for fast and easy installation of joints and the repair of cables. An adapter is included which enables the cable vise to be used for the installation of terminations. Suitable for field installation and for workshop use. When fixed to a work bench, the upper part with the clamps can be used without the legs. Cable vise for the installation of joints and the repair of cables.

Cable Vise Adapter and Clamp (comes with Cable Vise)
Adapter and clamp for the installation of terminations



Tools Sets



IT-1000-006 - Assortment of Tools

- 1x Pipe Wrench, size 9.84" (250 mm)
- 1x Side cutter, size 6.30" (160 mm)
- 1x Pincers, size 7.08" (180 mm)
- 1x Combination Pliers, size 7.08" (180 mm)
- 1x Scissors, size 7.87" (200 mm)



IT-1000-019 - Installation tool for mechanical connectors

This tool avoids the cable cores from being over bend during installation of mechanical connectors Application diameter range: .59"-2.36" (15-60 mm). Length of handle: 8.07" (205 mm)



734587-1 - Cable Tie Gun

- For cable ties 3.3-4.8 mm
- Thickness up to 1.6 mm
- Automatic cut-off
- Adjustable tension setting

Stripping Tools



IT-1000-030-2 - Screen Removal Tool

- Screen Removal Tool IT-1000-030-2 for bonded screens on round conductors of MV Cables includes: 1 spare blade, silicone grease and Allen key delivered in a robust polypropylene box.
- Suitable for one and three core cables.
- Application range over insulation .39"-1.97" (10-50 mm), Min screen cutback .39" (10mm), variable cutting thickness



IT-1000-030-2-BLADE - SIML O-711744-1

- Cable Jacket/lead removal tool



SIMIL O711744-1

Cable jacket / lead removal tool PG2, cable diameter .83"-1.37" (21-33 mm)

SIML O-711745-1

Cable Jacket / lead removal tool-PG3 Cable Diameter 1.02"-2.04" (26-52 mm)

SIML O-711746-1

Cable Jacket / lead removal tool-PG3 Cable Diameter 1.85"-2.95" (47-75 mm)



SIML O-0711748-1

Strip insulation of MV cables of diameter between .55"-1.57" (14-40 mm)

SIML O-0711749-1

Strip insulation of MV cables of diameter between 1.50"-2.36" (38-60 mm)



LHM 1R 30/45 - O-0716541-1

To strip non-bonded semiconductive screen of MV cables of diameter between .55"-1.57" (14-40 mm)

Cable Clamps (CC)

FEATURES

- The brackets will be bolted to appropriate supporting steel work or cross-arms, using the galvanized steel fixing hardware, including two seven inch long bolts, with nuts and washers to suit.
- Supporting steelwork will need two holes drilled with centers five and one half inches apart to accept the “nuts, bolts and washers”.

APPLICATIONS

- TE's Raychem CC high voltage cable mounting brackets are made from a high density UV resistant black polymer and are designed to support larger diameter cables

BENEFITS

- ♦ Seven sizes accommodate cable diameters from less than 1 inch thru 4.17 inches.

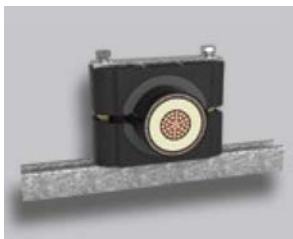

Catalog Number	Reference Application
CC26-38-FM-M12	1 - 1.5 (26 - 38)
CC38-50-FM-M12	1.5 - 1.97 (38 - 50)
CC50-60-FM-M12	1.97 - 2.36 (50 - 60)
CC60-70-FM-M12	2.36 - 2.76 (60 - 70)
CC68-81-FM-M12	2.68 - 3.19 (68 - 81)
CC80-92-FM-M12	3.15 - 3.62 (80 - 92)
CC92-106-FM-M12	3.62 - 4.17 (92 - 106)

PRODUCT SELECTION INFORMATION: DIMENSIONS IN INCHES (MM)

TE Part Number	Min Cable Ø	Max Cable Ø	Width	Depth	Bolt Hole Ctrs	Installed Height Max	Bolt Ø	Type
CC15-26-SN-M10	0.59 (15)	1.02 (26)	3.54 (90)	2.36 (60)	2.36 (60)	2.95 (75)	M10	Strut Nut
M12							Strut Nut	
M12							Flat Mount	
CC26-38-SN-M10	1.02 (26)	1.5 (38)	3.54 (90)	2.36 (60)	2.36 (60)	3.94 (100)	M10	Strut Nut
M12							Strut Nut	
M12							Flat Mount	
CC38-50-PL-M12	1.5 (38)	1.97 (50)	4.09 (104)	2.36 (60)	2.95 (75)	5.12 (130)	M12	Slider Plate
M12							Strut Nut	
M12							Flat Mount	
CC50-60-PL-M12	1.97 (50)	2.36 (60)	5.24 (133)	2.36 (60)	3.94 (100)	6.1 (155)	M12	Slider Plate
M12							Strut Nut	
M12							Flat Mount	
CC60-70-PL-M12	2.36 (60)	2.76 (70)	5.75 (146)	2.76 (70)	4.89 (114)	9.84 (250)	M12	Slider Plate
M12							Strut Nut	
M12							Flat Mount	
CC68-81-PL-M12	2.68 (68)	3.19 (81)	5.75 (146)	2.76 (70)	4.89 (114)	9.84 (250)	M12	Slider Plate
M12							Strut Nut	
M12							Flat Mount	
CC80-92-PL-M12	3.15 (80)	3.62 (92)	6.93 (176)	2.95 (75)	5.59 (142)	11.6 (295)	M12	Slider Plate
M12							Strut Nut	
M12							Flat Mount	
CC92-106-PL-M12	3.62 (92)	4.17 (106)	6.93 (176)	2.95 (75)	5.59 (142)	11.6 (295)	M12	Slider Plate
M12							Strut Nut	
M12							Flat Mount	

DOUB Clamps

FEATURES

- Captive elastomeric inserts for increased cable protection and containment
- Slider plate design maximizes clamp performance when under shock load
- 33% glass fiber reinforced polyamide resin, UV stabilised, self-extinguishing, impact resistant material

APPLICATIONS

- Range accepts cable diameters from 15-106mm

BENEFITS

- Bottom half of clamp can be mounted in position before positioning the cables leading to easier installation - especially in vertical applications
- Optimised for harsh environments with stainless steel hardware and self-extinguishing, UV stabilized materials

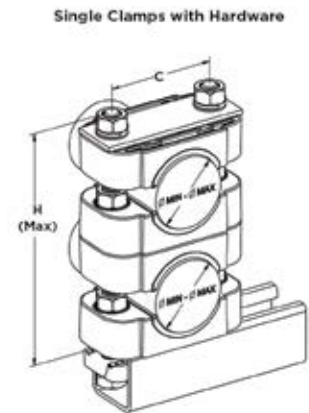
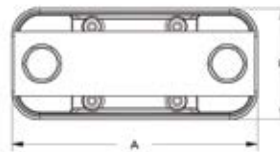
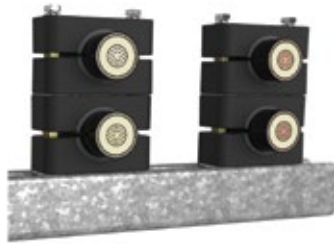

PRODUCT SELECTION INFORMATION: DIMENSIONS IN INCHES (MM)

Catalog Number	Min Cable \varnothing	Max Cable \varnothing	Width A	Depth B	Bolt Holes Ctrs C	Installed Height H max	Bolt \varnothing	Type
CC15-26-PL-M12-DOUB	0.59 (15)	1.02 (26)	3.54 (90)	2.36 (60)	2.36 (60)	5.10 (130)	M12	Slider Plate
CC15-26-SN-M12-DOUB								Strut Nut
CC26-38-PL-M12-DOUB	1.02 (26)	1.5 (38)	3.54 (90)	2.36 (60)	2.36 (60)	5.10 (130)	M12	Slider Plate
CC26-38-SN-M12-DOUB								Strut Nut
CC38-50-PL-M12-DOUB	1.5 (38)	1.97 (50)	4.09 (104)	2.36 (60)	2.95 (75)	6.69 (170)	M12	Slider Plate
CC38-50-SN-M12-DOUB								Strut Nut
CC50-60-PL-M12-DOUB	1.97 (50)	2.36 (60)	5.25 (133)	2.36 (60)	3.94 (100)	8.46 (215)	M12	Slider Plate
CC50-60-SN-M12-DOUB								Strut
CC60-70-PL-M12-DOUB	2.36 (60)	2.76 (70)	5.75 (146)	2.76 (70)	4.89 (114)	9.84 (250)	M12	Slider Plate
CC60-70-SN-M12-DOUB								Strut Nut
CC68-81-PL-M12-DOUB	2.68 (68)	3.19 (81)	5.75 (146)	2.76 (70)	4.89 (114)	9.84 (250)	M12	Slider Plate
CC68-81-SN-M12-DOUB								Strut Nut
CC80-92-PL-M12-DOUB	3.15 (80)	3.62 (90)	6.93 (176)	2.95 (75)	5.59 (142)	11.6 (295)	M12	Slider Plate
CC80-92-SN-M12-DOUB								Strut Nut
CC92-106-PL-M12-DOUB	3.62 (92)	4.17 (106)	6.93 (176)	2.95 (75)	5.59 (142)	11.6 (295)	M12	Slider Plate
CC92-106-SN-M12-DOUB								Strut Nut

TREFOIL Clamps

FEATURES

- Captive elastomeric inserts for increased cable protection and containment
- Slider plate design maximizes clamp performance when under shock load
- 33% glass fiber reinforced polyamide resin, UV stabilised, self-extinguishing, impact resistant material

APPLICATIONS

- Range accepts cable diameters from 28-38mm, 38-50mm, 60-70mm, 70-80mm
- Can be pole mounted using centre bolt or 2 bolts at extremities

BENEFITS

- Bottom half of clamp can be mounted in position before positioning the cables leading to easier installation - especially in vertical applications
- Optimised for harsh environments with stainless steel hardware and self-extinguishing, UV stabilized materials



Trefoil Clamps with Hardware

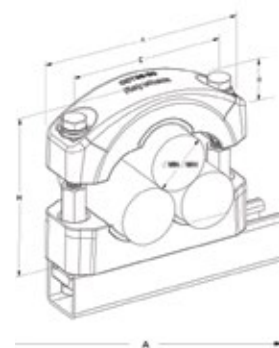

PRODUCT SELECTION INFORMATION: DIMENSIONS IN INCHES (MM)

Catalog Number	Min Cable Ø	Max Cable Ø	Width A	Depth B	Bolt Hole Ctrs C	Installed Height H Max	Bolt Ø	Type
CCT26-38-SN-M12	1.02 (26)	1.5 (38)	5.31 (135)	2.36 (60)	3.94 (100)	4.57 (116)	M12	Strut Nut
CCT26-38-PL-M12								Slider Plate
CCT26-38-M12-POLE								Pole Mount
CCT38-50-SN-M12	1.5 (38)	1.97 (50)	6.69 (170)	2.36 (60)	5.43 (138)	5.71 (145)	M12	Strut Nut
CCT38-50-PL-M12								Slider Plate
CCT38-50-M12-POLE								Pole Mount
CCT50-60-SN-M12	1.97 (50)	2.36 (60)	7.87 (200)	2.36 (60)	6.3 (160)	6.46 (164)	M12	Strut Nut
CCT50-60-PL-M12								Slider Plate
CCT50-60-M12-POLE								Pole Mount
CCT60-70-SN-M12	2.36 (60)	2.76 (70)	9.45 (240)	2.76 (70)	7.87 (200)	7.28 (185)	M12	Strut nut
CCT70-80-SN-M12	2.76 (70)	3.15 (80)	9.45 (240)	2.76 (70)	7.87 (200)	7.28 (185)	M12	Strut nut





Chapter 12 Applications & Technical Specifications

Applications by Cable Type	322
Low Voltage Tubing & Wraparound Sleeves	331
Splices	335
Terminations	340
Busbar/Wildlife Protection	345

1/C Power Cable (Up to 1000V)



	Application(s)	Product(s)	Heat Shrink	Cold Applied
	<ul style="list-style-type: none"> Sealed in-line splices Terminal lug seals Insulation Jacket repair 	<p>WCSM</p> <p>FCSM</p>	<p>●</p> <p>●</p>	
	<ul style="list-style-type: none"> Sealed in-line splices Insulation Jacket repair Terminal lug seals UF underground feeder cable splice 	<p>MWTM</p> <p>RNF-100</p> <p>GelWrap closure sleeve</p> <p>GILS closure</p> <p>RVS</p>	<p>●</p> <p>●</p>	<p>●</p> <p>●</p>
	<ul style="list-style-type: none"> Submersible secondary BUS connectors 	<p>GelWrap UF closure sleeve</p> <p>GelPort connector</p>		<p>●</p> <p>●</p>
	<ul style="list-style-type: none"> Sealed motor connections 2- or 3-wire stub splices 	<p>MCK</p> <p>MBSM</p> <p>GelCap SL splice cover</p> <p>GWRS</p>	<p>●</p> <p>●</p>	<p>●</p> <p>●</p>
	<ul style="list-style-type: none"> Insulation and jacket repair General wraparound sealing 	<p>CRSM</p> <p>MBSM</p> <p>GelWrap splice cover</p> <p>GWRS</p>	<p>●</p> <p>●</p>	<p>●</p> <p>●</p>
	<ul style="list-style-type: none"> Wraparound, sealed cable Tap splices 	<p>CRSM-CT</p> <p>GHFC MW</p> <p>GHFC</p> <p>GTAP</p>	<p>●</p>	<p>●</p> <p>●</p>
	<ul style="list-style-type: none"> End seals for storage and pulling Sealing of live ends (up to 1000V) 	<p>ESC</p> <p>RVC</p>	<p>●</p>	<p>●</p>
	<ul style="list-style-type: none"> Wire and cable marking Labels Hardware and Software 	<p>Identification Solutions</p>		
	<ul style="list-style-type: none"> Installation of heat shrink products 	<p>Propane torches</p> <p>Heat guns</p>		
	<ul style="list-style-type: none"> Sealing of uncoated tubing 	<p>Sealing mastics</p>		
	<ul style="list-style-type: none"> Duct sealing 	<p>RDSS</p>		
	<ul style="list-style-type: none"> Airport lighting kit 	<p>ALK</p>	<p>●</p>	
	<ul style="list-style-type: none"> Cable breakout boots Network protector sealing 	<p>CBR</p> <p>CBR-NPB</p>	<p>●</p> <p>●</p>	
	<ul style="list-style-type: none"> Cabinet feed through seals 	<p>CFTS</p>	<p>●</p>	
	<ul style="list-style-type: none"> Cable prep kit 	<p>P-63</p>		<p>●</p>

1/C Nonshielded Power Cable (5 kV)



	Application(s)	Product(s)	Heat Shrink	Cold Applied
	<ul style="list-style-type: none"> Indoor terminations (in enclosures) Outdoor (weather-exposed) terminations 	HVT-50	●	
	<ul style="list-style-type: none"> In-line splices 	HVS-500	●	
	<ul style="list-style-type: none"> Sealed motor connections 2 wire pigtail splices 	MCK-5 GelCap 8-motor connection	●	●

3/C Nonshielded Power Cables (5 kV)



	Application(s)	Product(s)	Heat Shrink	Cold Applied
	<ul style="list-style-type: none"> 3/C indoor terminations (in enclosures) 3/C outdoor (weather-exposed) terminations 	HVT-50 MOD-3-HVT	● ●	
	<ul style="list-style-type: none"> Cold-applied Terminations 	MOD-3-TFT MOD-3-CST CST		● ● ●
	<ul style="list-style-type: none"> 3/C in-line splices - no armor 	HVS-3-500 HVS-3/C mod kits	● ●	
	<ul style="list-style-type: none"> 3/C in-line splices - armored 	HVSA-3-500 HVSA mod kits	● ●	
	<ul style="list-style-type: none"> Sealed motor connections 2 wire pigtail splices 	MCK-5 GelCap 8-motor connection	●	●

1/C Shielded Power Cable (5-69 kV)

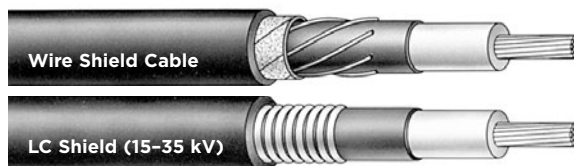
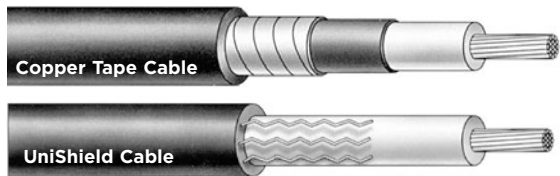

	Application(s)	Product(s)	Heat Shrink	Cold Applied
	<ul style="list-style-type: none"> Indoor heat shrinkable terminations for copper tape, wire shield, and UniShield cable (in enclosures) 	HVT-80-G (5/8 kV) HVT-150-G (15 kV) HVT-250-G (25 kV) HVT-350-G (35 kV) EHVT-460-G (46 kV) EHVT-690-G (69 kV) GHVT-690-G (69 kV)	● ● ● ● ● ● ●	
	<ul style="list-style-type: none"> Indoor heat shrink terminations with built in stress control 	HVT-Z-80-G/SG (5/8 kV) HVT-Z-150-G (15 kV) HVT-Z-250/350-G (35 kV)	● ● ●	
	<ul style="list-style-type: none"> Indoor cold-applied terminations (5-15 kV) for copper tape, wire shield and UniShield cable (in enclosures) 	TFT-150R-G (5/8 kV) TFT-E-G (5-15 kV) TFT-P-80R (5/8 kV) CSTI-150G		● ● ● ●
	<ul style="list-style-type: none"> Indoor heat shrinkable terminations LC-shield cable (in enclosures) (15-35 kV) 	HVT-150-LC (15 kV) HVT-250-LC (25 kV) HVT-350-LC (35 kV)	● ● ●	
	<ul style="list-style-type: none"> Outdoor heat shrinkable terminations for copper tape, wire shield, and UniShield cable (weather-exposed) 	HVT-80-G/SG (5/8 kV) HVT-150-SG (15 kV) HVT-250-SG (25 kV) HVT-350-SG (35 kV)	● ● ● ●	
	<ul style="list-style-type: none"> Outdoor heat shrink terminations with built in stress control, for copper tape, wire shield, and UniShield cable (weather exposed) 	HVT-Z-80-SG (5/8 kV) HVT-Z-150-SG (15 kV) HVT-Z-250/350-SG (25 kV) EHVT-460-SG (46 kV) EHVT-690-SG (69 kV) GHVT-690-SG (69 kV) GHVT-690-SSG	● ● ● ● ● ● ●	
	<ul style="list-style-type: none"> Outdoor heat shrinkable terminations for LC-shield cable (weather exposed) 15-35 kV 	HVT-150-SLC (15 kV) HVT-250-SLC (25 kV) HVT-350-SLC (35 kV)	● ● ●	
	<ul style="list-style-type: none"> Outdoor cold applied terminations, for copper tape, wire shield, and UniShield cable (weather exposed) (15-35 kV) 	TFT-150R-SG (15 kV) TFT-250R-SG (25 kV) TFT-350R-SG (35 kV) TFT-150E-SG (15 kV) TFT-250E-SG (15 kV) TFT-350E-SG (15 kV) TFT-150E-SLC (15 kV) TFT-250E-SLC (15 kV) TFT-350E-SLC (15 kV) CSTO-150G CSTO-280G		● ● ● ● ● ● ● ● ● ● ● ●
	<ul style="list-style-type: none"> In-line splices for copper tape, wire shield, and UniShield cable 	HVS-820S (5/8 kV) HVS-C-1520S (15 kV) HVS-1520S (15 kV) HVS-1550S (15 kV) HVS-2520S (25 kV) HVS-3520S (35 kV) EHVS-6920 (49/69 kV)	● ● ● ● ● ● ●	
	<ul style="list-style-type: none"> In-line splices for LC shield cable (15-35 kV) 	HVS-1530-LC (15 kV) HVS-2530-LC (25 kV) HVS-3530-LC (35 kV)	● ● ●	
	<ul style="list-style-type: none"> In-line splices for copper tape, wire shield, Unishield, flat strap and LC shielded cable (15-35 kV) 	CSJA-152X (15 kV) CSJA-282X (25/28 kV) CSJA-352X (35 kV)		● ● ●
	<ul style="list-style-type: none"> Wye splice H-tap splice 	HVSY-1520S (15 kV only) HVSH-Mod (15 kV only)	● ●	
	<ul style="list-style-type: none"> Sealing of live ends 	HVES-1520D (15 kV) HVES-2520D (25 kV)	● ●	
	<ul style="list-style-type: none"> Sealed motor connections 2 wire pigtail splices 	MCK-5 (5/8 kV) GelCap 8 motor connection	●	●

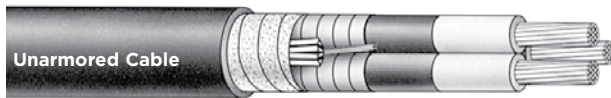

	Application(s)	Product(s)	Heat Shrink	Cold Applied
	<ul style="list-style-type: none"> 3/C indoor terminations (in enclosures) 	HVT-80-G (5/8 kV) HVT-150-G (15 kV) HVT-250-G (25 kV) HVT-350-G (35 kV) HVT-Z-80-G/SG HVT-Z-150-G HVT-Z-250/350-G in conjunction with MOD-3-HVT HVT-80-SG (5/8 kV) CSTI-150G (15 kV) CSTI-280G (28 kV) MOD-3-CST (28 kV)	● ● ● ● ● ● ● ● ●	● ● ●
	<ul style="list-style-type: none"> 3/C outdoor terminations (weather-exposed) 	HVT-Z-80-G/SG HVT-150-SG (15 kV) HVT-Z-150-SG HVT-250-SG (25 kV) HVT-350-SG (35 kV) HVT-250/350-SG in conjunction with MOD-3-HVT HVS-3-820S (5/8 kV)	● ● ● ● ● ●	
	<ul style="list-style-type: none"> 3/C in-line splices - no armor 	HVS-3-1520S (15 kV) HVS-3-2520S (25 kV) HVS-3/C (5-35 kV) HVSA-3-820S (5/8 kV)	● ● ● ●	
	<ul style="list-style-type: none"> 3/C in-line splices - armored 	HVSA-3-1520S (15 kV) HVSA (5-35 kV) MCK-5 (5/8 kV) CSJA-3-1520-ARMR CSJA-3-2820-ARMR CSJA-3-3520-ARMR GelCap 8 motor connection	● ● ●	● ● ● ●
	<ul style="list-style-type: none"> Sealed motor connections 2 wire pigtail splices 			● ● ●









1/C Unjacketed & Jacketed URD Power Cable (15-35 kV)



	Application(s)	Product(s)	Heat Shrink	Cold Applied
	<ul style="list-style-type: none"> Indoor heat shrinkable unjacketed or jacketed terminations (in enclosures) 	HVT-150-J (15 kV) HVT-250-J (25 kV) HVT-350-J (35 kV)	<ul style="list-style-type: none"> ● ● ● 	
	<ul style="list-style-type: none"> Indoor cold applied terminations (15-35 kV) 	TFT-150-E (15 kV) TFT-250-E (25 kV) TFT-350-E (35 kV) CSTI-150J (15 kV) CSTI-280J (28 kV)		<ul style="list-style-type: none"> ● ● ● ● ●
	<ul style="list-style-type: none"> Outdoor heat shrinkable unjacketed or jacketed terminations (weather-exposed) 	HVT-150-SJ (15 kV) HVT-250-SJ (25 kV) HVT-350-SJ (35 kV)	<ul style="list-style-type: none"> ● ● ● 	
	<ul style="list-style-type: none"> Outdoor cold applied terminations (15 - 35 kV) 	TFT-150-E (15 kV) TFT-250-E (25 kV) TFT-350-E (35 kV)		<ul style="list-style-type: none"> ● ● ●
	<ul style="list-style-type: none"> Unjacketed in-line splices 	HVS-1510S (15 kV) HVS-C-1510S-J (15 kV) HVS-2510E (25 kV) HVS-2510E-J (25 kV) HVS-3510S (35 kV) HVS-3510S-J (25 kV)	<ul style="list-style-type: none"> ● ● ● ● ● ● 	
	<ul style="list-style-type: none"> Jacketed in-line splices 	HVS-1510S-J (15 kV) HVS-C-1510S-J (15 kV) HVS-2510E-J (25 kV) HVS-3510S-J (35 kV) CSJG-151X (15 kV) CSJG-281X (25/28 kV) CSJG-351X (35 kV) CSJA-JCN/EG-1510 (15kV) CSJA-JCN/EG-2810 (25 kV) CSJA-JCN/EG-3510 (35 kV)	<ul style="list-style-type: none"> ● ● ● ● 	<ul style="list-style-type: none"> ● ● ● ● ●
	<ul style="list-style-type: none"> Unjacketed repair splices 	HVS-1510E-R (15 kV) HVS-2510E-R (25 kV) HVS-3510S-R (35 kV)	<ul style="list-style-type: none"> ● ● ● 	
	<ul style="list-style-type: none"> Jacketed repair splices 	HVS-3510S-R (35 kV) HVS-3510S-RJ (35 kV) HVS-1510E-RJ (15 kV) HVS-2510E-RJ (25 kV)	<ul style="list-style-type: none"> ● ● ● ● 	
	<ul style="list-style-type: none"> Sealing of live ends 	HVES-1520D (15 kV) HVES-2520D (25 kV)	<ul style="list-style-type: none"> ● ● 	
	<ul style="list-style-type: none"> Jacket/elbow sealing 	ESA RVS-SK GelWrap ES Splice Closure CES	<ul style="list-style-type: none"> ● 	<ul style="list-style-type: none"> ● ● ●
	<ul style="list-style-type: none"> Jacketed cable grounding kits 	JGK-MS (15-35 kV)	<ul style="list-style-type: none"> ● 	







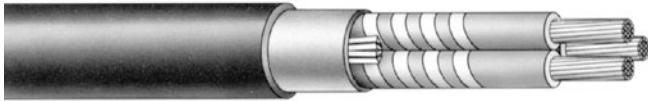



**Paper-Insulated, Lead-Covered (PILC) Cable/
Varnished Cambric-Insulated, Lead-Covered (VCLC) Cable**

	Application(s)	Product(s)	Heat Shrink	Cold Applied
 	<ul style="list-style-type: none"> 1/C PILC indoor/outdoor terminations 	HVT-1590-G/SG (15 kV)	●	
	<ul style="list-style-type: none"> 1/C PILC-to-PILC splices 1/C PILC-to-poly transition splices 	HVS-1580D (15 kV) HVS-2580E (25 kV) HVS-3580D (35 kV) CATJ-1580 (15 kV) CATJ-2880 (28 kV)	● ● ●	● ●
	<ul style="list-style-type: none"> 1/C PILC-to-poly transition "reducer" splices 	HVSR-1580 (15 kV) HVSR-2580E (25 kV)	● ●	
	<ul style="list-style-type: none"> Wye splices (PILC-to-PILC splices or PILC-to-poly transition splices) H-tap splices 	HVSY-1580D (15 kV only) HVSH-1580 MOD (15 kV)	● ●	
	<ul style="list-style-type: none"> Sealing of live ends 	HVES-1520D (15 kV) HVES-2520D (25 kV)	● ●	
	<ul style="list-style-type: none"> 1/C PILC elbow adapter 	HVE-1590 (15 kV) Adapter for 1/C PILC elbows	●	
	<ul style="list-style-type: none"> Lead repair kit for PILC cables 	HVS-LR	●	



**Paper-Insulated, Lead-Covered (PILC) Cable/
Varnished Cambric-Insulated Lead-Covered (VCLC) Cable**

	Application(s)	Product(s)	Heat Shrink	Cold Applied
 	• 3/C PILC indoor/outdoor terminations	HVT-3-1590-G/SG (15 kV)	●	
	• 3/C PILC to 3/C PILC splices	HVS-3-1590S (shorty-15 kV) HVS-3-1590 (15 kV) HVS-3-2590 (25 kV)	● ● ●	
	• 3/C PILC to three 1/C poly trifurcating transition splices	HVS-T-1580S (15 kV) HVS-T-2580D (25 kV) HVS-T-3580S (25 kV) CATJ-T-1580 CATJ-T-2880	● ● ●	● ●
	• 3/C PILC to 3/C poly	HVS-3-1580S (15 kV)	●	
	• 3/C PILC to 3/C poly armor	HVSA-3-1580S (15 kV)	●	
	• 3/C PILC to three 1/C poly trifurcating transition "reducer" splices	HVSR-T-1580 (15 kV) HVSR-T-2580E (25 kV)	● ●	
	• 3/C PILC to three 1/C PILC trifurcating splices	HVS-T-1590S (15 kV)	●	
	• Sealing of live ends	HVES-3-1590 (15 kV) HVES-3-2590 (25 kV)	● ●	
	• Lead repair kit	HVS-LR	●	

Flexible Cable (Up to 2 kV)

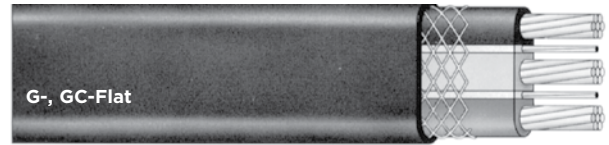
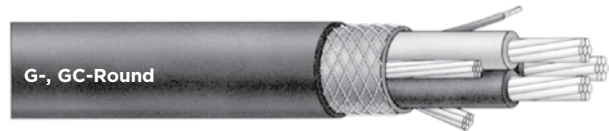

	Application(s)	Product(s)	Heat Shrink	Cold Applied
	<ul style="list-style-type: none"> Sealed, in-line splices Multiconductor splices 	LV-MSK	●	
	<ul style="list-style-type: none"> General wraparound sealing 	MRS	●	
	<ul style="list-style-type: none"> Cable jacket repair 	CRPS		

Flexible Cable (5-25 kV)

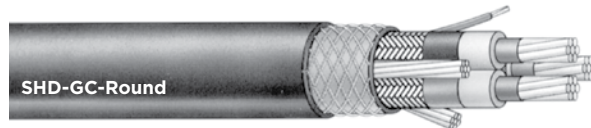
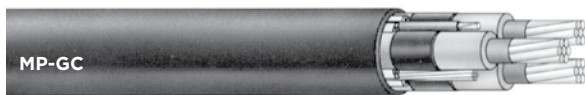

	Application(s)	Product	Heat Shrink	Cold Applied
	<ul style="list-style-type: none"> Indoor terminations (in enclosures) Outdoor (weather-exposed) terminations (5-25 kV) 	HVT-M	●	
	<ul style="list-style-type: none"> Sealed, in-line 3/C splices (5-8 kV) 	HV-MSK	●	
	<ul style="list-style-type: none"> Insulation (2 kV) and jacket repair General wraparound sealing 	MRS	●	
	<ul style="list-style-type: none"> Cable jacket repair 	CRPS		

Bus Insulation Configuration

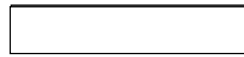
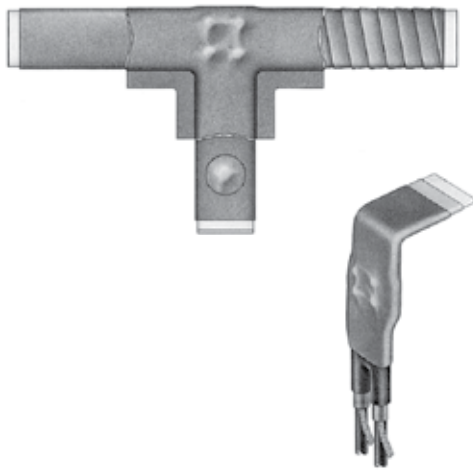

Straight Bus Runs

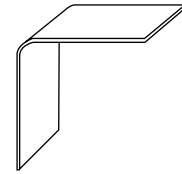

Bends and Edgewise Elbows

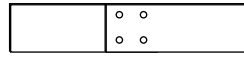

Bolted Bus Connections

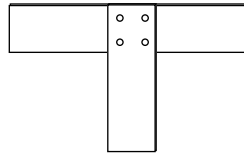

Tee Connections

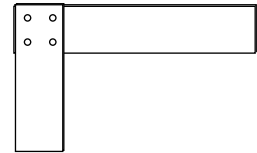

Flat Elbow Connections

	Application(s)	Product(s)
	<ul style="list-style-type: none"> Bus insulation-slide-on access required 	LVIT BPTM/BBIT
	<ul style="list-style-type: none"> Bus insulation-slide-on access not required 	LVBT HVBT
	<ul style="list-style-type: none"> Field-fabricated insulating covers 	HVIS

Cable-to-Bus Connection Configurations 1-4 Cable(s) Phase

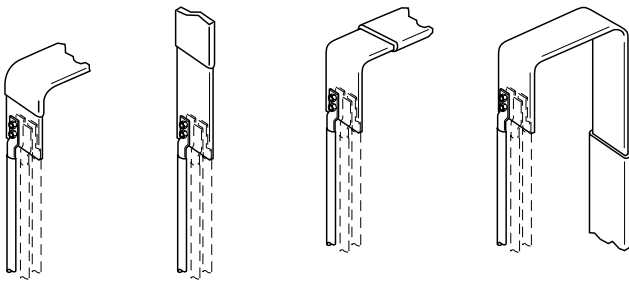

	Application(s)	Product
	<ul style="list-style-type: none"> Switchgear in-line cable-to-bus connections 	HVBC

Low-Voltage Tubing and Wraparound Sleeves

General Purpose Cable Accessories (1000 V)

TE offers a complete line of Raychem brand general purpose heat shrinkable and cold applied power cable accessories that consistently provide outstanding mechanical protection, complete moisture sealing, and excellent electrical insulation for a broad range of low voltage applications.

Heat Shrink Products

TE's Raychem invented heat-shrinkable products in 1959 and the Raychem brand continues to be the world leader in heat shrink technology and design. Our heat shrink products continue to be upgraded and improved to provide the best performance and value possible.

Rugged Mechanical Protection

The tough, abrasion-resistant, cross-linked polyolefin construction of general-purpose products provides mechanical protection equal to the cable jacket. In addition, the one-piece solid protective layer cannot unravel or slip off.

Watertight Seals

Most heat shrinkable products are coated with a high-performance adhesive that melts and flows when heated, forming a durable bond that seals out water and dirt.

General purpose sealants are also available for use with uncoated tubings and other moisture sealing applications.

Superior Electrical Insulation

Heat shrinkable products not only conform tightly to the connection, but they are also pre-engineered to shrink consistently to the required insulation thickness.

Cold Applied Products

Cold applied products offer superior sealing and electrical insulation. Our revolutionary PowerGel sealant provides the best and quickest cold applied seal. By combining the properties of solids and liquids, PowerGel sealant conforms to intricate shapes to completely seal out water and contaminants.



Low-Voltage Tubing and Wraparound Sleeves

Material Properties

Test Method	Test Method	WCSM Heavy Wall	FCSM Heavy Wall	MWTM Medium Wall	RNF-100 Thin Wall	CRSM Wrap-Around
Physical						
Tensile strength	ASTM D 412	1750 psi min.	1750 psi min.	2000 psi min.	1500 psi min.	2450 psi min.
Ultimate elongation	ASTM D 412	350% min.	350% min.	350% min.	200% min.	350% min.
Accelerated aging (168 hrs at 150°±2°C)	ASTM D 2671					
Tensile strength	ASTM D 412	1750 psi min.	1600 psi min.	2000 psi min.		2000 psi min.
Ultimate elongation	ASTM D 412	350% min.	200% min.	300% min.		300% min.
Low-temperature flexibility (4 hrs. at temp. indicated)	ASTM D 2671	No cracking (-55°C)	No cracking (-40°C)	No cracking (-40°C)	No cracking (-55°C)	No cracking (-40°C)
Flammability	ASTM D 2671		(60 sec max.)		Self-extinguishing	
Electrical						
Dielectric strength (at 0.04 inch)	ASTM D 149 (at 0.10 inch)	430 V/mil min. (at 0.04 inch)	330 V/mil min.	500 V/mil min. (at 0.04 inch)	500 V/mil min.	500 V/mil min.
Volume resistivity ohm-cm min.	ASTM D 257 ohm-cm min.	1 x 10 ¹² ohm-cm min.	1 x 10 ¹³ ohm-cm min.	1 x 10 ¹² ohm-cm min.	1 x 10 ¹⁴	1 x 10 ¹²
Chemical						
Resistance to liquids	ASTM D 543	●	●	●		●
Tensile strength	ASTM D 412	1450 psi min.	1600 psi min.	2000 psi min.	1000 psi min.	2000 psi min.
Ultimate elongation	ASTM D 412	300% min.	300% min.	300% min.		300% min.
Corrosive effect (16 hours at 150°±2°C)	ASTM D 2671	No corrosion			No corrosion at 175°C	
Fungus resistance	ASTM G 21	Pass rating 1	Pass rating 1	Pass rating 1	Pass rating 1	Pass rating 1
Technical Specifications						
ANSI C119.1-1986		●	●			●
UL 486D-1986		●				
UL Standard 224					●	
CSA 22.2		●			●	
Western Underground Guide 2.5		●				
MIL-I-23053/15, Class 1 & 2					●	
Flame-retardant per IEEE 383, ICEA-S-19-81			●			

*Flame-Retardant

Note: Blank space indicates that property was not measured during product qualification.

Low-Voltage Tubing and Wraparound Sleeves

Material Properties

Physical	Test method	MCK	ESC	CBR
Tensile strength	ASTM D 412	1450 psi min.	1750 psi min.	1500 psi min.
Ultimate elongation	ASTM D 412	300% min.	200% min.	300% min.
Accelerated aging (168 hours at temperature indicated)	ASTM D 2671			
Tensile strength	ASTM D 412	1000 psi min. (175°±2°C)	1750 psi min. (150°±2°C)	1250 psi min. (150°±2°C)
Ultimate elongation	ASTM D 412	200% min. (175°±2°C)	200% min. (150°±2°C)	100% min. (150°±2°C)
Low-temperature flexibility (4 hours at -40°±3°C)	ASTM D 2671	No cracking	No cracking	No cracking
Flammability	ASTM D 635	Self-extinguish (120 sec. max.)		

Electrical

Dielectric strength (at .075 inch)	ASTM D 149	250 V/mil min.	200 V/mil min.	250 V/mil min.
Volume resistivity	ASTM D 257	1 x 10 ¹² ohm-cm min.	1 x 10 ¹² ohm-cm min.	1 x 10 ¹² ohm-cm min.

Chemical

Resistance to liquids, transformer oil to VDE 0370 (168 hours at 23°±2°C)	ASTM D 543			
Tensile strength	ASTM D 412	1150 psi min.	1750 psi min.	1250 psi min.
Ultimate elongation	ASTM D 412	240% min.	200% min.	240% min.
Corrosive effect(16 hours at 175°±2°C)	ASTM D 2671	No corrosion		
Resistance to fungi	ASTM G 21	Pass rating 1	Pass rating 1	Pass rating 1

Technical Specifications

ANSI C119.1-1986		●	●	
Flame-retardant per IEEE 383, ICEA-S-19-81		●		

Note: Blank space indicates that property was not measured during product qualification.

Material Properties

Physical	Test Method	S1052	S1085	S1171	S1174	S1251
Softening point	ASTM E 28	70°C min.		140°C min.	140°C min.	
Adhesive peel strength:						
Polyethylene		1 lb/in min.	5.5 lb/in min.		5 lb/in min.	6 lb/in min.
Steel		2 lb/in min.			5 lb/in min.	
Aluminum			4.4 lb/in min.			
Copper			4.4 lb/in min.			
Low-temperature flexibility (4 hours at temperature indicated)	ASTM D 2671	No cracking (-40°C±3°C)	No cracking (-30°C±2°C)		No cracking (-40°C±3°C)	No cracking (-40°C±3°C)

Electrical

Dielectric strength min. (0.04 inch)	ASTM D 149	300 V/mil min.	200 V/mil min.	200 V/mil min.	300 V/mil min.	300 V/mil
Volume resistivity	ASTM D 257	1 x 10 ¹² ohm-cm min.	1 x 10 ¹² ohm-cm min.	1 x 10 ¹² ohm-cm min.	1 x 10 ¹² ohm-cm min.	1 x 10 ¹² ohm-cm min.
Tracking & erosion resistance	ASTM D 2303		No tracking or erosion to top surface or flame failure after: 1 hr at 2.00 kV 1 hr at 2.25 kV 1 hr at 2.50 kV			

Chemical

Corrosive effect (16 hours at 121°±2°C)	ASTM D 2671	No corrosion		No corrosion	No corrosion	
Fungus resistance	ASTM G 21	Pass rating 1			Pass rating 1	

Note: Blank space indicates that property was not measured during product specification.

Low-Voltage Tubing and Wraparound Sleeves

Material Properties

PowerGel Testing	Test Methods	S.I. Units	Imperial Units
Dielectric strength (4 mm/016 inch wall thickness)	40 kV/cm min.	100 V/mil min.	
Volume Resistivity	1×10^{12} Ohm cm min.	1×10^{12} Ohm cm min.	
Resistance to Liquids Chemicals: 1 N na ₂ SO ₄ 0,1 N NaOH; 0, 1 N NaCl; water; Ethylene Glycol	ASTM D543 modified: 10.0 cm x 1.0 cm x 0.4 cm, test bar supported on wire mesh, 24 hours immersion, IPA rinse after immersion, 24 hr. drying	No visible cracking, max. 2% weight change, 80% retention of elongation and tensile strength	No visible cracking, max. 2% weight change, 80% retention of elongation and tensile strength
Corrosive Effect	ASTM D2671	No corrosion	No corrosion
Resistance to Fungi 4.5 cm diameter x 0.4 cm thickness petridish	ISO 846	Pass rating 1 or less	Pass rating 1 or less
UV Resistance 10.0 cm x 1.0 cm x 0.4 cm est bar, UVB 313; 250 cycles (2000 hrs); 4 hours UV at 60°C then 4 hours at 50°C with condensation	ISO 4892/3	80% tensile strength retention, no visible cracking	80% tensile strength retention, no visible cracking

Splices



Polymeric wye and H-tap splices produce dependable water tight seals between the main and tap cable(s) with no taping.



Heat shrink, high-voltage splice kits install quickly and uniformly.

Superior Long-Term Performance

Even in the harshest environments, TE's Raychem brand cable splices are ideal for the following direct-burial and manhole applications: copper tape, wire shield, UniShield LC-shield, PILC, and jacketed/unjacketed URD cables. The splices not only match the requirements of cable test specifications but also meet or exceed the requirements of IEEE-404. Throughout the world, TE Raychem splices are meeting the needs of industrial, utility, and mining customers with outstanding performance and reliability.

Positive Moisture Sealing and High Abrasion-Resistance

Internal moisture seals protect the cable from water that may enter the cable through a damaged jacket outside of the splice area. In addition, the adhesive-lined re-jacketing sleeve provides a moisture-resistant seal that is field-tested and superior to interference fits. Underwater cyclic aging tests per ANSI C119.1-1986 and IEEE 404 specifications confirm this. In addition, the outer jacket is superior to tape in abrasion resistance and cannot unravel or fray.

Fast, Consistent Installations

Simple heat-shrinking techniques reduce installation time and training. Pre-engineered kits help to ensure consistent performance while minimizing potential installation errors.

Unique Repair Splices

Specially designed to speed URD cable repair, TE's Raychem brand URD repair splices reduce cable preparation and required excavation space, thus minimizing total repair costs. With our superior heat-shrink adhesive system, our splices reliably seal fault-deformed cables. In addition, one splice repair kit may replace two conventional splices for most repairs.

The typical TE Raychem brand splice—based on heat-shrink technology, specialized materials, and pre-engineered designs—delivers reliable performance.

A close look at one of our polymeric cable splices shows how each component draws on TE technical excellence and field experience to rebuild every function of the cable.

All cable splices must rebuild these critical cable functions:

- Electrical stress control
- Insulation and semiconductive layer
- Shielding and grounding
- Environmental and mechanical protection

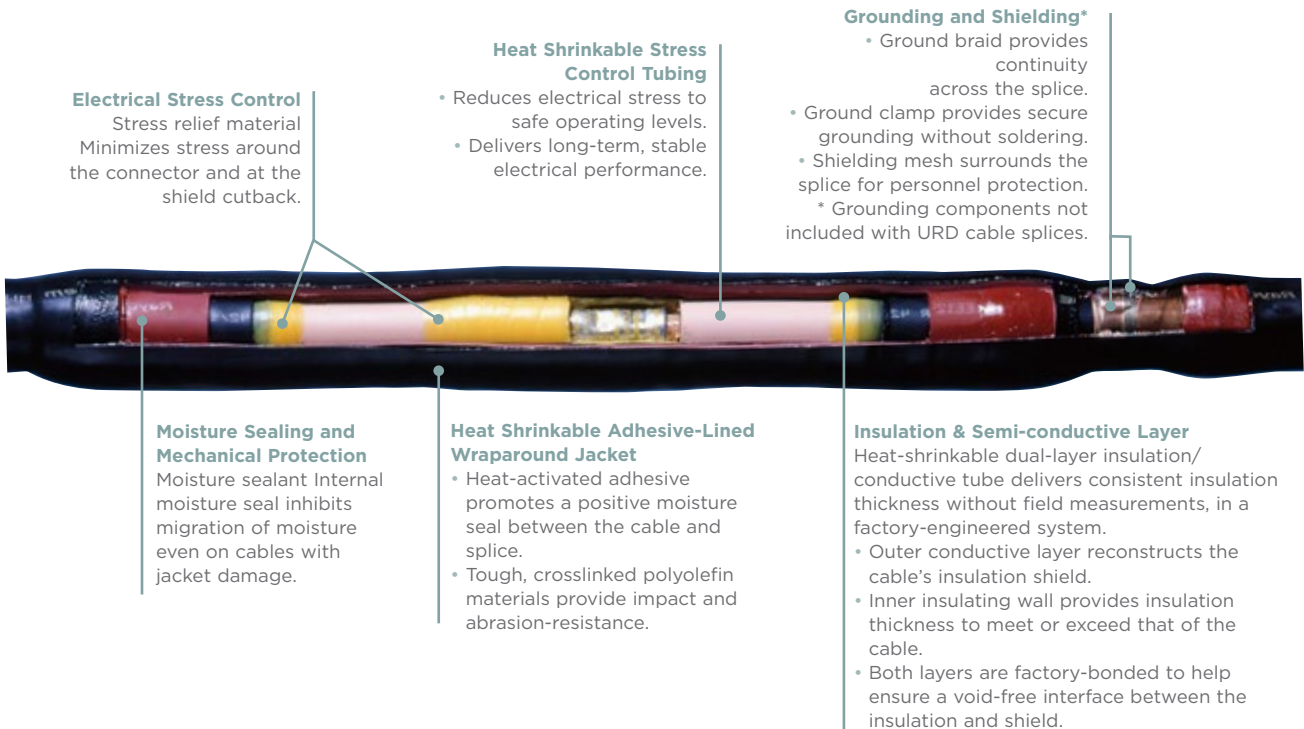

Positive, Consistent Oil Stop

Unlike other oil stops, TE Connectivity unique system combines heat shrinkable, high temperature oil barrier tubing and oil blocking stress relief material (SRM) to avoid splice failures due to oil leakage.

Long-Term Reliability

Both the component materials and the complete splices have undergone rigorous, long-term test programs, including pressurized load-cycling to maximum cable system overload temperatures.

Elimination of Lead Sleeve Failures

Moisture is the worst enemy of PILC cable systems. A major source of leakage problems is cracking of lead sleeves and wipes due to cable flexing or corrosion. TE's design replaces these components with heavy-duty, heat shrinkable jacketing and adhesive seals, so moisture problems are minimized.

Field-Tested Performance

Since TE "converts" the PILC cable to a "polymeric equivalent," all TE's designs can then use the effective components found in our plastic cable splices. For more than a decade, these products have compiled an excellent service history in more than a million installations worldwide.

Easy, Consistent Installations

By "converting" the PILC cable to a "polymeric equivalent," these TE Raychem brand kits eliminate compound-filling and difficult lead-wiping. Also, heat-shrinking means no time-consuming insulation, stepping or penciling, hand taping, and stress cone building.

Reduced Installation and Training Time

You get on and off the job site quicker. There's no lead-wiping, no compound pouring, and no waiting for "cool downs" and "top-ups." Time and cost are drastically reduced, with users reporting installation cost savings of up to 75 percent.

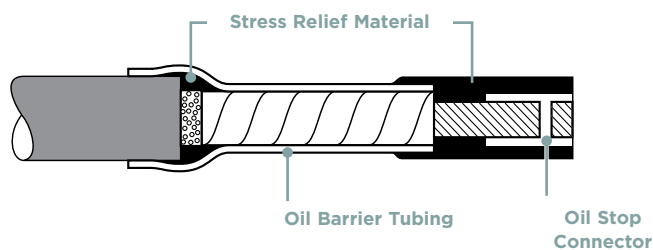

To produce a simple, field-tested oil stop system, TE's Raychem brand splices utilize high-temperature oil barrier tubing and oil-blocking stress relief material.

**Easy to Install Wye Splices**

PILC wye splices produce water-tight seals between the main and tap cable with no tedious, complex taping. The simple construction does not require lead wiping, so installation is fast and easy. These splices are versatile, accommodating both PILC-to-PILC and PILC-to-polymeric constructions.

Breakout Seal

Heat-activated sealants combine with heat-shrinkable components to produce a field-tested moisture resistant system for the critical branch breakout area.

Intercable Insulation

A soft (pliant) preformed profile conforms tightly to the cable surfaces upon shrinking. This provides insulation in the area between the main and branch (or tap) cable.

Positive Oil Stop Systems for 3/C Cables

TE provides a highly effective and easily installed oil stop system, using standard heat-shrinkable components:

- Adhesive-lined, conductive breakout
- Converts the 3/C cable into three 1/C cables
- Provides an oil- and pressure-resistant seal
- Grounds the conductive tubing to the lead sheath

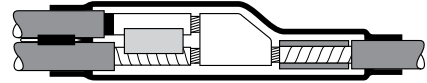

Oil Blocking Stress Relief Material

- During shrinking, the material softens and conforms around the individual conductors forming an oil-resistant seal
- Provides electrical stress relief between the insulated conductors on belted cable
- Conductive tubing
- Reshields the individual insulated conductors

Oil Barrier Tubing

- Locks the oil in the PILC cables, converting each conductor to a polymeric equivalent

Elastomeric Technology

The elastomeric splice component is supplied in an expanded form. In this form, the heat-shrinkable outer wall holds the insulating layer at a wide diameter. Application of heat causes the outer wall to shrink, allowing the insulating layer to contract at the same time and closely fit the splice. The rubber-like characteristics of the material enable the splice to follow the thermally induced dimensional changes of the cable insulation.

The elastic memory of the material helps to ensure that the correct insulation-wall thickness is obtained for the defined application range of the component.

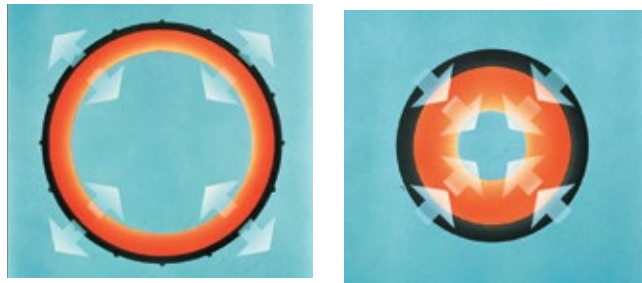

Cable Splice without Stress Control

The figure below shows a computer-simulated plot of electrical stress in a splice without stress control. Areas of high stress exist near the edge of the semi-con and connector as shown by the concentrations of equipotential lines. These high stresses must be lowered to prevent premature insulation damage and splice failures.

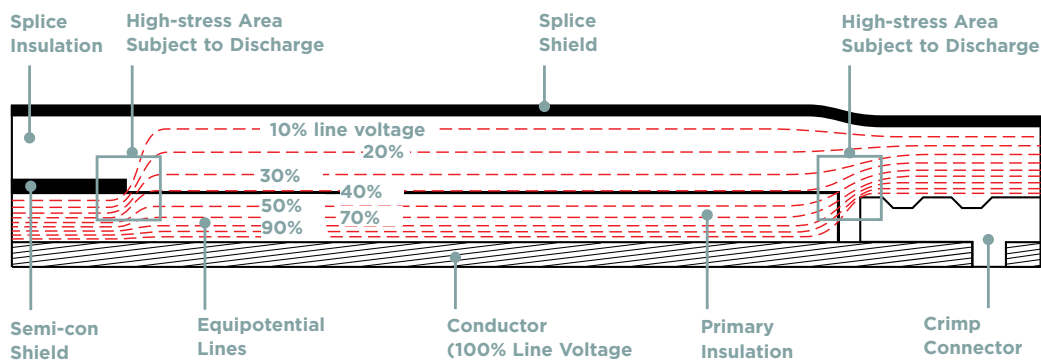

Cable Splice with Stress Control System

TE's stress control system controls the distribution of the electrical field in the splice. The equipotential lines are distributed uniformly, reducing the stresses within the splice to levels required for longer service life. This is achieved by the unique resistive and capacitive properties of the heat-shrinkable tubing and stress relief material (SRM).

The stress control materials reduce stress through their electrical properties rather than the geometry of the splice or correct positioning of a Faraday cage. Stress cone buildup is diminished, resulting in a slim, compact splice and significantly decreasing splice installation time.

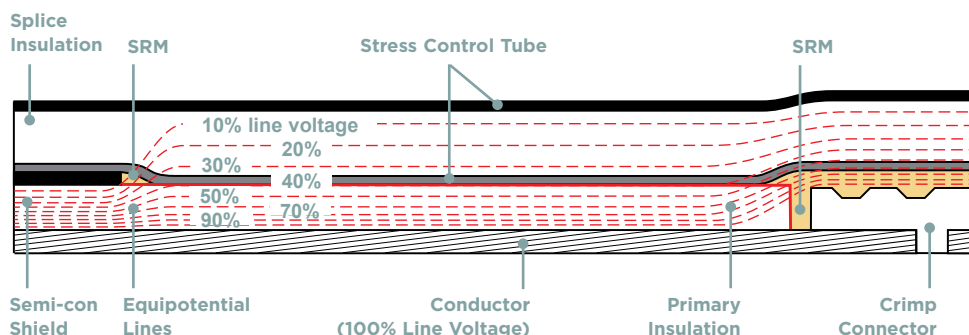

Test and Performance Data for Polymeric and URD Splices

To help provide long-term reliability and durability, TE's Raychem brand splices have been subjected to extensive testing in both the laboratory and actual field environments. Kits are factory-designed and tested to meet cable system requirements as summarized in the table below. Test levels are drawn from relevant sections of existing industry standards, including the following: IEEE 404, IEEE 593, ANSI C119.1 and ANSI C119.4, IEEE 386, AEIC CS5, AEIC CS6

Test Description	HVS-8XX (5-8 kV)	HVS-15XX (15 kV)	HVS-25XX* (25 kV)	HVS-35XX (35 kV)	EHVS69XX (46/69 kV)
Partial discharge (min. kV) for 3 pC or less	7	13	22	30	60
AC withstand,1 min (kV)	23	35	52	69	120 (15 min)
AC withstand,5 min (kV)	21	39	65	90	N/A
AC withstand,5 hr (kV)	16	31	50	71	100 (6 hr)
DC withstand,15 min (kV)	45	75	105	140	240
Impulse withstand 1.2 x 50 μ s (crest kV)	95	110	150	200	350
Water sealing properties**	Pass	Pass	Pass	Pass	

* Also meets requirements of 25/28 kV systems.

**Refer to EDR-5101, "A Survey of the Water Sealing Properties of Raychem brand Heat Shrinkable Splices" for testing details. IEEE 404 requires testing without jacket installed for load cycling under water. All TE heat-shrink splices pass this new requirement.

Recommended Guide Specification for Polymeric and URD Splices (5-35 kV)

Please feel free to use the following in your design specification:

Power cable splices for nonshielded or shielded solid dielectric cable and unjacketed or jacketed URD (concentric neutral) cable shall be factory-engineered kits that rebuild the primary cable insulation, shielding and grounding systems, and outer jacket equivalent to that of the original cable.

When assembled on cable, the splice shall be capable of passing the electrical test requirements of IEEE-404 and the water immersion tests of ANSI C119.1.

Splices shall be of a uniform-cross-section, heat shrinkable polymeric construction utilizing an impedance-layer stress control tube and high-dielectric-strength insulating layers.

The outer insulating layer shall be bonded to a conducting layer for shielding. The splice shall be re-jacketed with a heat shrinkable adhesive-lined sleeve to provide a waterproof seal.

The splice shall accommodate a range of cable sizes and be completely independent of cable manufacturer's tolerances. Splices shall be capable of being properly installed on out-of-round cable per relevant ICEA and AEIC standards. Kits shall accommodate a range of commercially available connectors.

Splices for armored cables shall provide a means of reinstating the armor over the span of the installed splices. Wye splices shall include a sealant profile to seal the area between the branch and the main cable.

The splice manufacturer shall provide a test report demonstrating compliance with the above requirements. Splices shall be manufactured by TE or approved equivalent.

Test and Performance Data for PILC Splices

PILC splices are fully engineered to provide a long, trouble-free service life. They are factory-designed and tested to meet PILC cable system requirements, as summarized in the table below.

Test levels are drawn from relevant sections of existing industry standards, including those that follow:

- IEEE 404 (power cable splices)
- IEEE 48 (terminations)
- AEIC-1 (paper cable)
- AEIC-CS5 (XLPE cable)
- AEIC-CS6 (EPR cable)
- ANSI C119.1 (sealed insulated underground connection system)

Test and Performance Data for PILC Splices

Electrical	Voltage Class		
	15 kV	25 kV	35 kV
AC withstand test, 6 hours	35 kV	58 kV	80 kV
DC withstand test, 15 minutes	55 kV	75 kV	100 kV
Impulse withstand (BIL) 1.2 x 50 μ s	110 kV	150 kV	200 kV

Load Cycle/Pressure

Current load cycling, 2 cycles of 5 hours heating, 3 hours cooling to conductor temperature of 110°C with applied overvoltage and maximum continuous internal oil pressure; no breakdown, oil leakage	Pass	Pass	Pass
Maximum continuous internal oil pressure	15 psig	15 psig	15 psig
Maximum continuous conductor temperature	90°C	90°C	90°C
Maximum overload conductor temperature	110°C	110°C	110°C

Sealing

Water immersion outer jacketing system	ANSI C119.1	ANSI C119.1	ANSI C119.1
Proof test on oil blocking system: TE test method—no oil diffusion	Pass	Pass	Pass

1. Not applicable to live end seals.
2. Maximum continuous/emergency conductor temperature for Wye splices: 70°C.
3. Test methods discussed in IEEE paper 84 T&D 340-6, "The extension of heat shrinkable components for use with 1/C transition and paper cable splices," by Mackevich, et al.

Recommended Guide Specification for PILC Splices (15-35 kV)

Please feel free to use the following in your design specification: Splices shall be factory-manufactured kits to suit the specific type and size of the cables to be spliced.

The electric field distribution in the splice shall be controlled by a heat shrinkable tubing having a complex impedance when energized with an AC voltage. A dual-wall tubing with a co-extruded outer conductive layer to form a void-free interface between the insulation and shield shall be used.

Kits shall be factory-engineered to contain all necessary materials, except connector, and provide an oil block and oil seal, electrical stress control, insulation, shielding, and environmental sealing. The kit shall allow for external grounding. Major kit components shall be heat shrinkable.

The splice insulation shall not require a lead sleeve, lead wipe, or any kind of filling.

The splice manufacturer shall provide a test report, upon request, demonstrating that the splice performance is equivalent to the cables per relevant sections of IEEE-404, AEIC-1. Splices shall be load cycled with 15 psig internal oil pressure at 2.5x rated line-to-ground voltage at 110°C emergency overload rating. Splices shall also be subjected to a voltage withstand test sequence per listed standards.

Wye splices on PILC cable shall be tested to the requirements of ANSI C119.1. The test shall demonstrate the mechanical integrity, water sealing, and electrical properties of the outer jacket system.

Splices shall be manufactured by TE or approved equivalent.

Terminations



TE proven oil-sealing technology has been used for more than 18 years in medium-voltage transition joints. This technology is now put to work in our PILC termination kits.

Reliable, Field-Proven Performance

Independent testing and field experience have repeatedly proven the long-term stability, durability, and reliability of the TE's Raychem HVT system, even in highly polluted environments. The nontracking, insulating outer jacket can withstand the rigors of long-term electrical stress and surface pollution without loss of performance. The nontracking material offers the additional benefit of being maintenance free, with no need for periodic cleaning. Extensive load cycle testing verifies the long-term thermo-mechanical compatibility between the termination system and the cable.

Ease of Installation

HVT kits can be installed on all cable types without special adapters or accessories. No special tooling or connectors are required since HVT kits accept all common compression or terminal lugs. The HVT installation method also provides generous cable cutback and component positioning tolerances, further reducing installation variability. Heat-shrinking allows the kits to be easily inspected, either visually or by simple touch, to help ensure proper installation.

Always Ready for the Job-Even in Emergencies

HVT kits have an unlimited shelf life. They remain ready to use on short notice, so you have no worries about scrapping aged inventory or being caught with useless products during an emergency or on a time-critical project.

Flexible and Versatile

An HVT system may be installed upright or inverted and can bend to the same bending radius as the cable. Slim and lightweight, the system can also be mounted directly to fuse cutouts or other devices, eliminating the cost of additional supporting brackets and cross arms.

46 and 69 kV

At voltages as high as 69 kV the need for proven stress control is even more important. The materials used in our 46 and 69 kV terminations (as with all lower voltages) are suitable for severely polluted areas—and for all installation conditions, including top feed installation.

The material is designed to be resistant to impact damage from transportation or vandalism, a typical problem for heavy, inflexible porcelain products. TE Connectivity Raychem brand 46/69 kV terminations also require no compound filling which can leak over time.

Cold Applied Termination System

TFT terminations are designed for customers who want TE material technology in a cold-applied system. The cold-applied terminations also provide positive positioning of the stress control patch.

TE's Raychem brand HVT system features a nontracking, insulating surface that can withstand long-term electrical stress and surface pollution.



Terminations

HVT

Shielding and Solderless Grounding (included in polymeric cable kits except URD)

Moisture Sealing

Nontracking, high-voltage sealant:

- Provides a watertight connector seal when combined with heat-shrinkable material
- Will not harden or crack

Additional Creepage for Outdoor Applications

Heat shrinkable skirts:

- Increase surface creepage distance
- Easily adapt terminations for outdoor use
- May be inverted for terminations facing downward

Electrical Stress Control and Insulation (8 kV and up)

Heat shrinkable stress control tubing:

- Reduces the electrical stress gradient at the end of the cable shield to safe operating levels
- Shrinks to fit out-of-spec cable
- Provides long-term electrical performance

Nontracking, Heat shrinkable Outer Insulation Tubing

- Provides excellent UV stability
- Withstands polluted environments
- Is proven to withstand severe application

Stress relief material

- Minimizes stress at the shield cutback
- Applies easily, smoothing the step at the cable semi-con edge and filling any voids
- Acts as a secondary moisture seal.

Ground Braid

- Provides shield continuity

Ground Clamp

- Has a constant-force roll spring, which provides secure grounding without soldering

Moisture Sealing

- Nontracking, high-voltage sealant

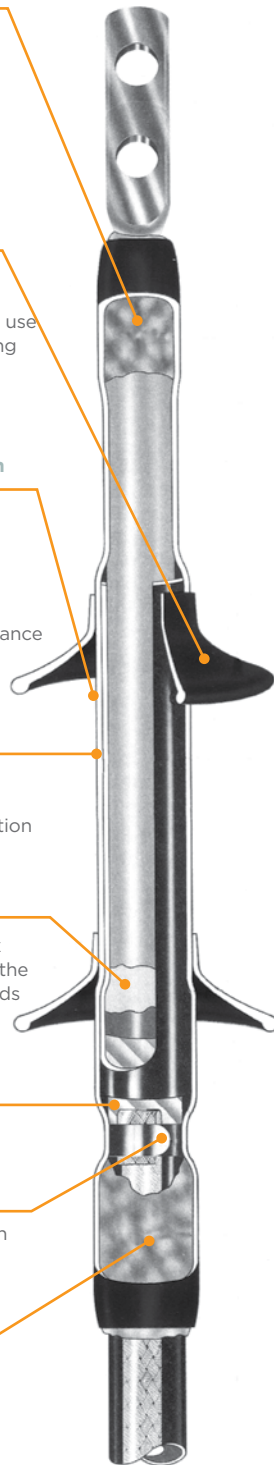

TFT

Moisture Sealing

Nontracking, high-voltage sealant:

- Provides a watertight connector seal
- Will not harden or crack

Additional Creepage for Outdoor Applications

Molded skirts:

- Increase surface creepage distance

Electrical Stress Control

Metal Oxide Matrix stress control patch:

- Reduces the electrical stress gradient at the end of the cable shield to safe operating levels
- Conforms to fit out-of-spec cable
- Provides long-term electrical performance

Nontracking, Termination Body

- Provides excellent UV stability
- Withstands polluted environments
- Is proven to withstand severe applications

Moisture Sealing

- Nontracking, high-voltage sealant spring clamp and solder-block ground braid available for metallic shielded cables

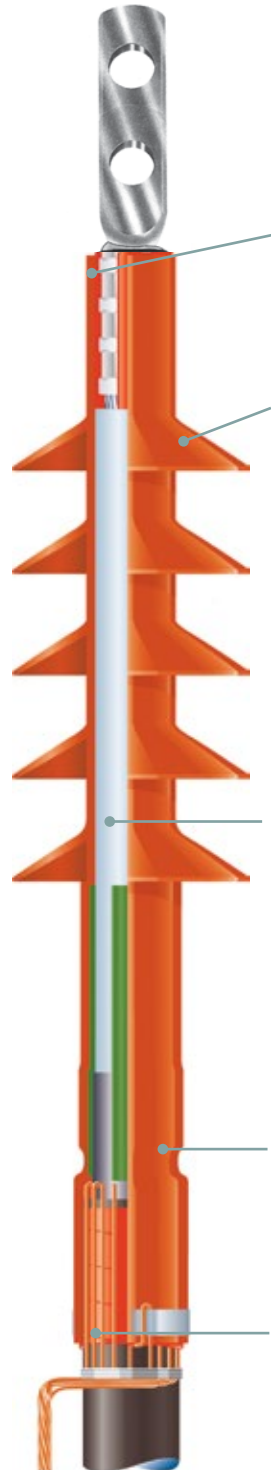

HVT Testing Data

TE's Raychem brand high-voltage terminations are fully qualified per IEEE-48 as Class I terminations to provide a long, trouble-free service life. Independent testing and field experience have repeatedly proven the long-term durability, reliability, and stability of the HVT system, even in highly polluted environments. TE's proven nontracking, insulating jacket can withstand the rigors of long-term electrical stress and surface pollution without loss of performance. The nontracking material is maintenance free and does not require periodic cleaning. Extensive load-cycle testing verifies the thermomechanical compatibility between the termination system and cable.

Recommended Guide Specifications

Please feel free to use one or all of the following in your design specifications:

Medium-Voltage Terminations (through 69 kV)

Shielded power cable termination kits shall be factory engineered for the application. The kits shall consist of high-permittivity, high-resistivity, heat shrinkable stress control tubing, and outer insulation tubing and skirts (outdoor applications) made from UV-stable, nontracking (per ASTM D 2303) materials. Heat-activated sealant materials to help prevent moisture ingress and contamination should also be included. Termination kits shall meet or exceed all rating requirements of IEEE-48 for Class I terminations and the test sequence prescribed by IEEE-404, including 130°C load cycling and 130°C impulse withstand.

Multi-Conductor Shielded Cable Terminations

In addition to the phase terminations, multi-conductor termination kits shall provide a heat shrinkable breakout boot, factory-coated with sealant for strain-relief and sealing purposes. Each kit shall include lengths of heat shrinkable tubing to help prevent corrosion and shifting of the shielding layers between the boot and the phase-termination installation point.

When grounding and/or ground check conductors are included, the kit includes lengths of heat shrinkable tubing and sealant material to seal each conductor from the boot to its connection point.

Nonshielded Cable Terminations (2-5 kV)

Termination kits for nonshielded power cables installed in contaminated indoor or outdoor environments are factory engineered to provide UV-stable, nontracking (per ASTM D 2303 and the Ontario Hydro accelerated tracking wheel test) exterior surfaces and complete environmental sealing for the termination area. Termination kits shall consist of heat shrinkable tubing, skirts (outdoor applications), and sealing boots (for 3/C only) supplied with heat-activated sealant materials to help prevent moisture ingress and contamination.

Product and Voltage Class 1

Test Description	HVT-80 (5-8 kV)	HVT-150 (15 kV)	HVT-250 (25 kV)	HVT-350 (35 kV)	EHVT-460 (46 kV)	EHVT-690 (69 kV)
AC withstand, 1 minute, (kV)	35	50	65	90	120	175
DC withstand, 15 minutes, (kV)	65	75	105	140	170	245
Partial discharge (min. kV) for 5 pC or less	9	13	21.5	30	40	60
Impulse withstand 1.2 x 50 μs, crest kV (outdoor)	95	110	150	200	250	350
Impulse withstand 1.2 x 50 μs, crest kV (indoor)	80	95	125	150	250	350
Continuous current rating	Equal to cable ampacity					
Wet withstand, 10 seconds, kV rms	30	45	60	80	100	145
Dry withstand, 6 hours, kV rms	25	35	55	75	100	120

Electrical Stress Control

Shielded power cables require electrical stress control when terminated. When the insulation shield is removed from a cable, the electrical field is concentrated at the cutback point, causing high electrical stress. If the stress is great enough, it can cause the air to break down, resulting in corona. High-stress areas also cause internal discharges. Corona or internal discharges will ultimately destroy the cable insulation, causing premature failure.

Cable Termination Without Stress Control

The diagram below shows an energized cable termination without stress control. The electric field intensity is greatest where the equipotential lines (line of constant voltage) are concentrated.

Note the concentration near the edge of the semi-con shield. Stress control is required here to reduce the electrical stress below levels at which the air would break down or discharges would occur in the insulation.

Cable Termination with TE's Unique Stress Control System

With TE's stress control tube installed, the equipotential lines are spread out, distributing the electrical field and reducing the electrical stress to the cable insulation's operating level, as shown in the diagram below. This is achieved by the unique resistive and capacitive properties of the heat-shrinkable material. Note that no diameter buildup is required as in a conventional stress cone that utilizes its geometry to reduce stress.

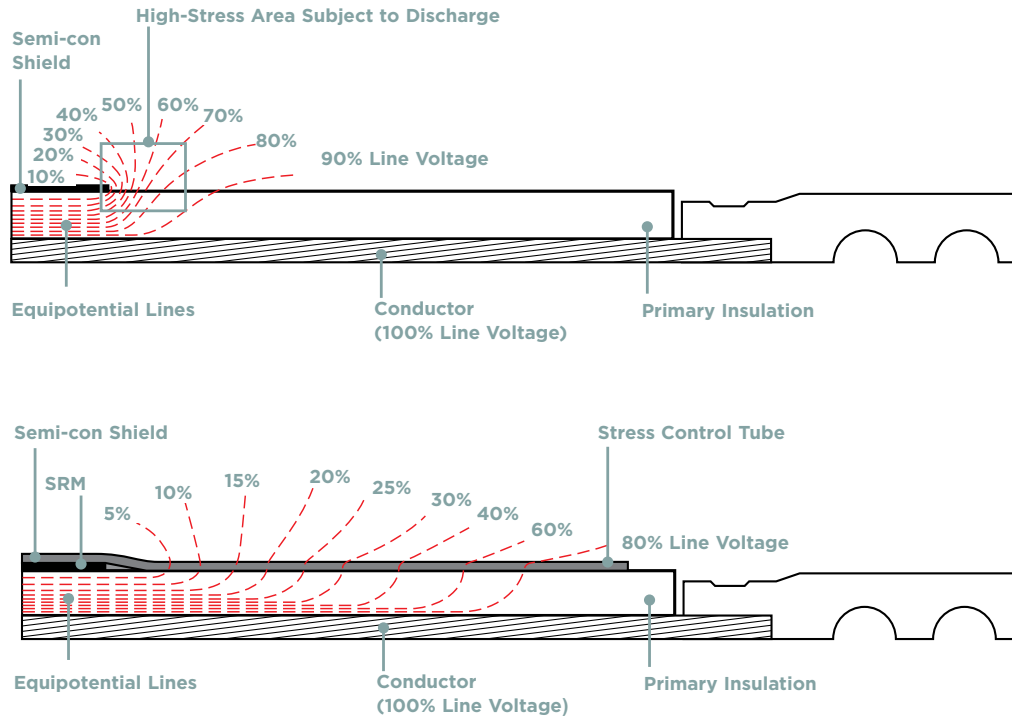

Recommended Air Clearance (Heat shrink and Cold applied Products) Phase/Phase and Phase/Ground
 The stress control system provides a linear voltage distribution from the lug at high voltage to the shield termination at ground potential. If the termination is installed too close to another phase termination or grounded metal, the electric stress in the air gap will rise to a level where discharge or flashover may occur. The table and diagrams below indicate the minimum clearances needed between various termination configurations. These clearances are based on IEEE Basic Impulse Levels (BIL).

Minimum Clearance¹ (inches/millimeters)

BIL (kV)	A	B	C ²	D
95 (5-8 kV)	6.5 (160)	3.5 (90)	1.2 (30)	0.8 (20)
110 (15 kV)	7.0 (175)	4.0 (100)	1.4 (35)	0.9 (23)
150 (25 kV)	9.0 (225)	6.0 (150)	1.6 (40)	1.0 (25)
200 (35 kV)	13.0 (325)	9.0 (225)	2.0 (50)	1.4 (35)

¹ Values are based on normal operating conditions. Humid or poorly ventilated environments may require additional air clearance.

² For skirted, outdoor terminations, the value for "C" is equal to the distance from the edge of one skirt to another or from a skirt to ground.

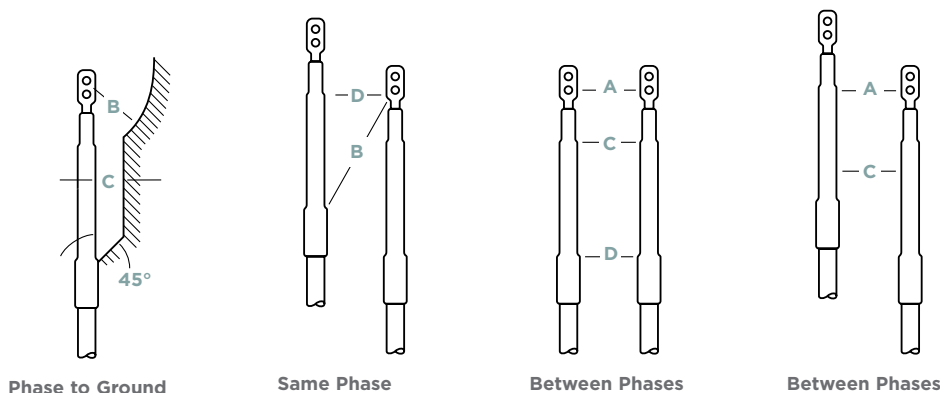

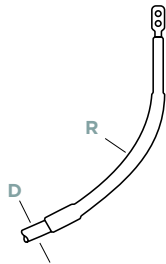

Bending Radius

Recommended cable bending radius TE Raychem brand terminations are as flexible as the original cable. A cable end should not be bent to a radius less than that recommended by the manufacturer.

D = Cable jacket O.D.

R = 10 x D—Minimum bending radius (consult cable manufacturer's values and check them against TE. Select the higher of the two values. Preheat cable to approximately 80°C before bending.)

TFT Testing Data

These terminations are fully qualified per IEEE-48 as Class 1 terminations to provide a long, trouble-free service life. These terminations incorporate TE material technology in a cold applied system. These terminations have an elastomeric tubing that is formulated for long-term performance in typical extreme termination environments. The non-tracking material is maintenance-free and does not require periodic cleaning.

This series of products features the latest in advanced stress control systems using Metal Oxide Matrix technology to provide superior electrical performance.

Voltage class

Test description	(5-8 kV)	(15 kV)*	(25 kV)	(35 kV)
AC withstand, 1 minute, (kV)	35	50	65	90
DC withstand, 15 minutes, (kV)	65	75	105	140
Partial discharge (min. kV) for 5 pC or less	9	13	21.5	30
Impulse withstand 1.2 x 50 μ s, crest kV (outdoor)	95	110	150	200
Wet withstand, 10 seconds, kV rms	30	45	60	80
Dry withstand, 6 hours, kV rms	25	35	55	75

*With or without sheds

Busbar/Wildlife Protection



The TE Raychem Raysulate electrical insulation family of products offers easy-to-install busbar insulation systems for both the field engineer and the manufacturer. Raysulate electrical insulation products provide flashover protection against the accidental bridging of conductors commonly caused by birds and animals.

The system is ideal for both enclosed and exposed bus work and for connections in switchgear lineups, substations, and other electrical apparatus. It also permits clearance reduction in many applications.

Excellent Electrical and Thermal Performance

Raysulate electrical insulation products are manufactured from high dielectric strength, radiation-crosslinked, heat shrinkable materials. The high-voltage materials are specially formulated to provide high resistance to arcing and tracking. All high-voltage and low-voltage materials provide high-thermal endurance throughout the range of switchgear operating temperatures. They offer field-proven reliability and long service life in harsh environments. In addition, these heat shrink tubing, tape, and sheet products can be preformed and preshrunk in the customer's shop, allowing easy, quick installation in the field.

Compatibility with Other Insulating Materials

All Raysulate heat shrinkable electrical insulation products are compatible with other solid switchgear insulating materials. Raysulate electrical insulating materials are not subject to stress crazing or embrittlement and are not adversely affected by common plasticizers used in conventional switchgear insulating materials.

Flame-retardant Materials

Most Raysulate heat shrinkable electrical insulating materials pass the ANSI C37.20 switchgear insulation flammability tests.

Reduced Corrosive and Toxic Fumes

Raysulate electrical insulation materials contain no chlorine compounds. This minimizes noxious and corrosive effects in case of equipment fault or fire.

For Protection, Repair, and Maintenance

Raysulate heat shrinkable electrical insulating tubes, tapes, and sheets provide a complete system for electrical repair and maintenance of enclosed or exposed buswork and for connections in switchgear and electrical equipment. They offer:

- Fast, easy installation and removal
- A flexible system to cover most conductor shapes and sizes
- Consistent, reliable installation
- Consistent electrical and thermal performance
- Proven corrosion protection
- Compatibility with conventional solid insulating materials
- Protection against flashovers



HVBC Bus Connection Kit

For the Electrical Equipment Manufacturers

The Raysulate system of insulation-enhancement components addresses the needs of electrical equipment manufacturers. The superior material properties and versatility of these components enhance the quality and reliability of the final product. Raysulate electrical insulating materials feature:

- Low-hazard formulation
- Flexibility
- Track resistance
- Rugged, easy installation
- Excellent electrical and thermal performance
- Unlimited shelf life
- Corrosion protection of conductor
- TE assistance and support for testing and applications

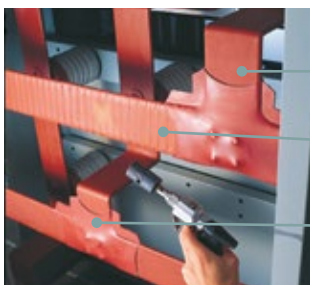

BBIT/BPTM
Bus Insulation Tubing



HVBT Bus Insulation Sheet



HVBT Bus Insulation Tape

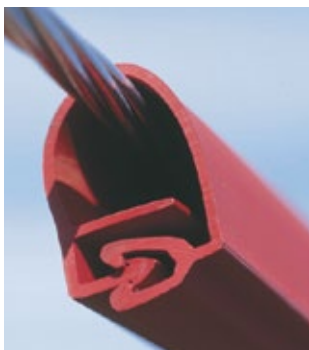

MVLC-18-A/U Overhead Line Cover

For Outdoor Equipment

TE's Raychem Raysulate electrical insulation products provide a complete system of insulation enhancement for high-voltage busbars and related equipment in outdoor substations and overhead lines. The system offers:

- Easy installation in the field
- Insulation for many different shapes, including busbars, joints, tees, insulators/bushing connections
- Flashover protection against accidental bridging
- Protection of wildlife and from wildlife-induced outages
- Excellent UV and weathering resistance
- Protection against corrosion
- Protection against incidental tree branch contact



MVCC



HVCE



BISG-24



BCAC-IC-8D/18 Bushing Cover



BCAC-G-AR-5D/2 Lighting Arrester Cover

MEDIUM-VOLTAGE PRODUCTS*

TEST AND PERFORMANCE DATA

Material Properties	Test Method	Requirements	BBIT BPTM	BCIC HVIS	BCAC, HVCE-WA HVBT OLIT	HVCE	MVLC	BISG RRBB
Electrical								
Volume resistivity	ASTM D-257, IEC 93	ohm-cm min.	1.0x10 ¹³	1.0x10 ¹³	1.0x10 ¹³	1.0x10 ¹³	1x10 ¹³	1x10 ¹³
Dielectric constant	ASTM D-150, IEC 250	maximum	5.0	5.0	5.0	5.0	5.0	5.0
Dielectric strength	ASTM D-149, IEC 243	V/mil at 1.3mm min. V/mil at 1.5mm min. V/mil at 2mm min. V/mil at 2.5mm min V/mil at 3mm min.	500 450 400 350	330	330	250	550	380
Thermal								
Thermal endurance	IEEE 1-1969, IEC 216	minimum	105°C	105°C	105°C**	110°C	105°C	
Accelerated aging for 168 hours	ISO 188	Tensile strength Ultimate elongation.	1450 psi 300%	1450 psi 300%	1450 psi. 300%	1100 psi 100%	1450 psi 25%	2450 psi
		Aging Temp	120°C	120°C	120°C	120°C	150°C	120°C
Chemical								
Flammability	ANSI C37.20	Pass	Pass	Pass	Pass			
Water absorption	ISO/R 62, procedure A	1% max. after 14 days at 23°C	Pass	Pass	Pass	Pass	Pass	Pass
Low-temperature flexibility	ASTM D-2671, procedure C	No cracking after 4 hr	Pass -40°C	Pass -40°C	Pass -40°C	Pass -40°C	Pass -20°C	Pass -40°C
Corrosion	Copper Mirror, ASTM D-2671, procedure B	Passed visual inspection after 16 hr		Pass 150°C	Pass 150°C		Pass 135°C	
Physical								
Tensile strength	ASTM D-638, ISO 37	psi. (min.)	1450<4 mm, 1150>4 mm	1450	1450	1150	1450	2450
Ultimate elongation	ASTM D-638, ISO 37	% minimum	300	300	300	300	200	25

Note: Blank spaces indicate that property was not measured during product qualification.

*Each product's voltage rating will be displayed with its selection information.

**Properties measured on backing material only. HVBT and OLIT have a 90°C maximum continuous operating temperature limit.

Busbar Insulation Technical Data

This table indicates clearance differences for rectangular busbars without and with various Raysulate electrical insulation products. These spacings are derived from BIL, AC-withstand, DC-withstand, and discharge-extinction tests on a limited number of busbar configurations insulated with Raysulate electrical insulation products.

Due to the wide range of possible busbar geometries, these spacings should not be adopted without actual testing by the user. Sharp electrodes and unusual geometries will require wider spacings.

Note: Phase-to-phase distances are reduced more than phase-to-ground distances because it is assumed that each phase is insulated.

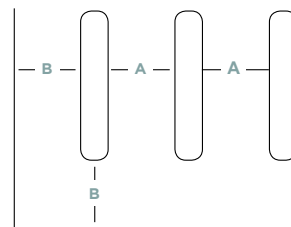

SELECTION INFORMATION: DIMENSIONS IN INCHES(MM)

System Voltage kV	BIL kV	Uninsulated Clearance (Indoor)		BBIT Clearance (Indoor)		BPTM, HVBT, and HVIS Clearance (Indoor)	
		A*	B**	A*	B**	A*	B**
15	95	7.5 (190)	5.0 (125)	2.2 (55)	2.6 (65)	3.4 (85)	4.2 (105)
25	125	10.5 (265)	7.5 (190)	2.8 (70)	4.0 (100)	4.5 (115)	6.0 (150)
35	150	12.5 (320)	9.5 (240)	5.6 (140)	7.5 (190)	6.5 (165)	8.0 (200)

* Phase-to-phase

** Phase-to-ground

Recommended Guide Specification

Please feel free to use the following in your design specification:

Insulation for energized bus components and connections shall consist of tubing, tape, and sheets that are factory-engineered to meet applicable switchgear performance requirements.

All insulation components shall be fabricated from flexible, crosslinked, heat shrinkable polymeric materials formulated to provide high dielectric strength, adequate thermal endurance at bus operating temperatures, and tracking and erosion resistance.

The insulation materials shall contain no halogen compounds and be compatible with other commercial, factory-installed bus insulation materials.

Materials shall be installable at temperatures as low as -40°F. Adhesive coatings on tape and sheet products shall not adhere to metal surfaces, thus permitting easy re-entry to the connections.

The insulation supplier shall furnish technical data to document design and performance to these requirements and functional testing of the complete insulation system in accordance with ANSI/IEEE C37.20.

Catalog Number	Page	Catalog Number	Page	Catalog Number	Page	Catalog Number	Page
69437	29	602502	19	1-602031-6	15, 17, 20	1099898-6	8
69611	29	602585	19	1-602031-7	15, 17, 20	1099898-7	8
69612	29	602586	19	1-602031-8	15, 17, 20	1099898-8	8
69684	31	1710725-7	23	1-602031-9	15, 17	1099898-9	8
69816	32	1-1099898-0	8	1-602121-0	15, 17	1099899-1	9
69847	31	1-1099898-1	8	1-602121-1	15, 17	1099899-2	9
69883	32	1-1099898-2	8	1-602121-2	15, 17	1099899-3	9
69900	32	1-1099898-3	8	1-602121-3	15, 17	1099899-4	9
69947	31	1-1099898-4	8	1-602121-4	15, 17	1099899-5	9
306814	31	1-1099898-5	8	1-602180-0	15, 17	1099899-6	9
600403	15, 16	1-1099899-0	9	1-602180-1	15, 17	1099899-7	9
600411	15, 16	1-1099899-1	9	1-602180-2	15, 17	1099899-8	9
600446	15, 16	1-1099899-2	9	1-602180-3	15, 17	1099899-9	9
600447	15, 16	1-1099899-3	9	1-602180-4	15	1099939-1	9
600448	15, 16	1-1099899-4	9	1-602180-5	15	1099939-2	9
600455	15, 16	1-1099899-5	9	1-602180-6	15	1099939-3	9
600456	15, 16	1-1099899-6	9	1-602300-0	15	1099939-4	9
600458	15, 16, 20	1-1099899-7	9	1-602300-1	15	1099939-5	9
600459	15, 16	1-1099899-8	9	1-602300-2	15	1099939-6	9
600463	19	1-1099899-9	9	1-602300-3	15	1099939-7	9
600464	19	1-1099939-0	9	1-602300-4	15	1099939-8	9
600465	15, 16, 20	1-1099939-1	9	1-602300-5	15	1099939-9	9
600466	15, 16	1-1099939-2	9	1-602300-6	15	1443208-1	18
600468	19	1-1099939-3	9	1-602300-7	15	1443209-1	18
600469	19	1-1099939-4	9	1-81723-0	39	1443259-1	18
600474	19	1-1099939-5	9	1-81723-1	39	1443268-1	18
602000	15, 16	1-1443402-0	10	1-81723-2	39	1443312-1	19
602001	15, 16	1-1443402-1	10	1-81723-3	39	1443316-2	18
602002	15, 16	1-1443402-2	10	1-83592-0	34, 36	1443402-1	10
602003	15, 16	1-1443402-3	10	1-83592-1	34, 36	1443402-2	10
602004	15, 16	1-1443402-4	10	1-83592-2	34, 36	1443402-3	10
602006	15, 16	1-1443402-5	10	1-83592-3	34, 36	1443402-4	10
602007	15, 16	1-1443402-6	10	1-83623-0	35, 36	1443402-5	10
602013	15, 16	1-1443402-7	10	1-83623-1	35, 36	1443402-6	10
602014	15, 16	1-1443403-0	10	1-83623-2	35, 36	1443402-7	10
602047	17	1-1443403-1	10	1-83623-3	35, 36	1443402-8	10
602080	28	1-1443403-2	10	1-83623-4	35, 36	1443402-9	10
602089	24	1-1443403-3	10	1-83623-5	35, 36	1443403-1	10
602091	24	1-1443403-4	10	1-83623-6	35, 36	1443403-2	10
602093	24	1-1443403-5	10	1-83623-7	35, 36	1443403-3	10
602097	24	1-1443403-6	10	1-83623-8	35, 36	1443403-4	10
602099	24, 41	1-1443403-7	10	1-83623-9	35, 36	1443403-5	10
602104	19	1-1579002-8	315	1-83630-0	35, 36	1443403-6	10
602107	28	1-275187-0	39	1-83631-1	35, 36	1443403-7	10
602115	10	1-275187-1	39	1-83631-2	35, 36	1443403-8	10
602121	15, 17	1-275187-2	39	1-83631-3	35, 36	1443403-9	10
602136	19	1-275187-3	39	1-83631-4	35, 36	1443413-2	30
602142	19	1-275187-4	39	1-83631-5	35, 36	1443414-1	30
602143	19	1-275187-5	39	1-83631-6	35, 36	1443442-1	30, 31
602162	19	1-275187-6	39	1-83631-7	35, 36	1443448-1	30
602163	19	1-275187-7	39	1-83631-8	35, 36	1443470-1	30
602173	19	1-275187-8	39	1-83631-9	35, 36	1443514-1	30
602174	19	1-276337-0	39	1-83843-0	23, 25	1443514-1	32
602180	15, 17	1-276337-1	39	1-83843-1	23, 24	1490489-1	315
602201	19	1-276337-2	39	1043413-1	30	169415-1	315
602237	19	1-276337-3	39	109423-1	18	1710500-1	28
602247	19	1-276337-4	39	109424-1	18	1710501-1	28
602248	19	1-276337-7	39	109433-1	18	1710523-1	28
602283	15, 16	1-276337-8	39	109703-1	18	1710722-1	23
602284	28	1-276337-9	39	109717-1	33	1710722-2	23
602285	26	1-602031-0	15, 16	1099898-1	8	1710722-3	23
602286	26	1-602031-2	15, 17	1099898-2	8	1710722-4	23
602287	26	1-602031-3	15, 17, 20	1099898-3	8	1710723-1	23
602300	15	1-602031-4	15, 17	1099898-4	8	1710723-2	23
602380	15, 16	1-602031-5	15, 17, 20	1099898-5	8	1710723-4	23

Catalog Number	Page	Catalog Number	Page	Catalog Number	Page	Catalog Number	Page
1710723-5	23	1710734-3	23	2182408-2	25	314196-1	29
1710723-6	23	1710734-4	23	2182408-3	25	314199-1	31
1710723-7	23	1710735-1	23	2182408-4	25	4-275187-0	39
1710723-8	23	1710735-2	23	2182408-5	25	4-276337-1	39
1710723-9	23	1710735-3	23	2182408-6	25	4-276337-2	39
1710724-1	23	1710735-4	23	2182410-1	39	4-276337-3	39
1710724-2	23	1710735-5	23	2182410-2	39	4-276337-4	39
1710724-3	23	1710735-6	23	2182410-3	39	4-276337-5	39
1710724-4	23	1710735-7	23	2182410-4	39	4-276337-6	39
1710725-1	23	1710735-8	23	2182452-1 MVG900	20	4-276337-7	39
1710725-2	23	1710735-9	23	2182452-2 MVG900	20	4-276337-8	39
1710725-4	23	1710736-1	23	2182452-3 MVG900	20	4-276337-9	39
1710725-5	23	1710736-2	23	2182452-4 MVG900	20	444031-1	47
1710725-6	23	1710736-3	23	2182452-5 MVG900	20	444033-1	47
1710725-7	23	1710737-1	23	275187-1	39	444385-1	47
1710725-8	23	1710737-2	23	275187-2	39	47667-8	29
1710725-9	23	1710737-3	23	275187-3	39	5-276337-1	39
1710726-1	23	1710737-4	23	275187-4	39	5-276337-3	39
1710726-2	23	1710737-5	23	275187-5	39	5-276337-4	39
1710726-3	23	1710737-6	23	275187-6	39	5-276337-5	39
1710726-4	23	1710737-7	23	275187-7	39	5-276337-6	39
1710727-1	23	1710737-8	23	275187-8	39	5-276337-7	39
1710727-2	23	1710883-1	24	275187-9	39	5-276337-8	39
1710727-3	23	1710883-2	24	275435-1	19	5-276337-9	39
1710727-4	23	1710883-3	24	275436-1	19	5-304668-3	29
1710727-5	23	1710883-4	24	276300-1	18	561118-1	30
1710727-7	23	1710884-1	24	276337-1	39	569398-1	27
1710727-8	23	1710884-2	24	276337-2	39	6-276337-0	39
1710727-9	23	1710884-3	24	276337-3	39	6-276337-2	39
1710728-1	23	1710884-4	24	276337-4	39	6-276337-4	39
1710728-2	23	1710885-1	24	276337-5	39	6-276337-5	39
1710728-3	23	1710885-2	24	276337-6	39	602031-8	15, 16
1710728-4	23	1710885-3	24	276337-7	39	602031-9	15, 16
1710729-1	23	1710885-4	24	276337-8	39	602046-1	15, 16
1710729-2	23	1710886-1	24	276337-9	39	602046-2	15, 16
1710729-4	23	1710886-2	24	276337-9	39	602046-3	15, 16
1710729-5	23	1710887-1	24	276478-1	19	602046-4	15, 16
1710729-7	23	1710887-2	24	276548-1	18	602046-5	15, 16
1710729-8	23	1710888-1	24	276915-1	18	602046-6	15, 16
1710729-9	23	1710888-2	24	277060-1	39	602046-7	15, 16
1710730-1	23	2-275187-8	39	277060-1,2,3	39	602046-9	15, 16
1710730-2	23	2-276337-0	39	277060-2	39	602061-0	47
1710730-3	23	2-276337-1	39	3-275187-0	39	602080-0	18
1710730-4	23	2-276337-2	39	3-275187-1	39	602080-1	18
1710731-1	23	2-276337-3	39	3-275187-3	39	602089-3	41
1710731-2	23	2-276337-4	39	3-275187-4	39	602121-1	15, 17
1710731-3	23	2-276337-5	39	3-275187-6	39	602121-2	15, 17
1710731-4	23	2-276337-8	39	3-275187-7	39	602121-3	15, 17
1710731-6	23	2-276337-9	39	3-275187-9	39	602121-4	15, 17
1710731-7	23	2-602031-0	15, 17	3-276337-0	39	602121-5	15, 17, 20
1710731-8	23	2-602031-1	15, 17	3-276337-1	39	602121-6	15, 17
1710731-9	23	2-602031-2	15, 17	3-276337-2	39	602121-7	15, 17
1710732-1	23	2-83623-0	35, 36	3-276337-3	39	602121-8	15, 17
1710732-2	23	2182383-1	25	3-276337-4	39	602121-9	15, 17, 20
1710732-3	23	2182383-2	25	3-276337-5	39	602180-1	15, 17
1710732-4	23	2182383-3	25	3-276337-6	39	602180-2	15, 17
1710733-1	23	2182384-1	25	3-276337-7	39	602180-3	15, 17
1710733-2	23	2182384-2	25	3-276337-9	39	602180-4	15, 17
1710733-4	23	2182384-3	25	306347-1	32	602180-5	15, 17
1710733-5	23	2182407-1	25	306348-1	32	602180-6	15, 17
1710733-6	23	2182407-2	25	306349-1	32	602180-7	17, 19, 20
1710733-7	23	2182407-3	25	306349-2	32	602180-8	15, 17
1710733-8	23	2182407-4	25	306350-2	32	602180-9	15, 17
1710733-9	23	2182407-5	25	308967-1	29	602283-1	15, 16
1710734-1	23	2182407-6	25	3090-NPS	260	602283-2	15, 16
1710734-2	23	2182408-1	25	3090-VFS	260	602283-3	15, 16

Catalog Number	Page	Catalog Number	Page	Catalog Number	Page	Catalog Number	Page
602283-4	15, 16	81723-2	39	83630-8	35, 36	AD-1358-LPG-REGW/GAGE	313
602283-5	15, 16	81723-4	39	83630-9	35, 36	AD-1432-ACDI0FT-LPG-HOSE	313
602283-6	15, 16	81723-5	39	83631-1	34, 36	AD-1434-ACD30FT-LPG-HOSE	313
602283-7	15, 16	81723-6	39	83631-2	34, 36	AD-1460-ACD-HEAT-SHLDGPA	313
602283-8	15, 16	81723-7	39	83631-3	34, 36	AD-1563-ACD-ADAPTER	313
602300-1	15	81723-8	39	83631-4	34, 36	AD-3015-04	313
602300-2	15	81723-9	39	83631-5	34, 36	AM-1-A	266
602300-3	15	83000-1	41	83631-6	34, 36	AM-1-A-NB	266
602300-4	15	83005-1	21	83631-7	34, 36	AM-2-A	266
602300-5	15	83005-2	21	83631-8	34, 36	AM-2-A-NB	266
602300-6	15	83005-3	21	83631-9	34, 36	AMR3030.2-120V	265
602300-7	15	83005-4	21	83653-1	15	AMR3030.3-120V	265
602300-8	15	83005-5	21	83653-2	15	ASBR-350-500/600-750-U	4
602300-9	15	83086-1	18	83653-3	15	ASBS-1000-U	4
602380-1	15, 16	83086-2	18	83653-4	15	ASBS-2-3/0	3
602380-2	15, 16	83364-1	28	83653-5	15	ASBS-2-350	3
602380-3	15, 16	83452-1	20	83747-1	43	ASBS-2-4/0-U	4
602380-4	15, 16	83452-2	20	83747-1	43, 44, 45	ASBS-2-U	4
602380-5	15, 16	83452-3	20	83747-2	43, 44, 45	ASBS-250-350-U	4
602380-6	15, 16	83452-4	20	83747-3	43, 44, 45	ASBS-3/0-500	3
602380-7	15, 16	83470-1	20	83747-4	43, 44, 45	ASBS-3/0-500-S	3
6060-VPS	261	83470-2	20	83748-1	43, 44, 45	ASBS-350-500-U	4
607453-2.1	315	83470-3	20	83748-2	43, 44, 45	ASBS-350-750	3
607501-1	31	83470-3	20	83748-3	43, 44, 45	ASBS-350-750	3, 6
608338-1	31	83470-4	20	83748-4	43, 44, 45	ASBS-500-750	3
608877-1	31	83470-4	20	83749-1	43, 44, 45	ASBS-600-1000	3, 6
6090-VPS	261	83470-9	20	83749-2	43, 44, 45	ASBS-600-750-U	4
6090-VPS-UL	261	83589-1	22	83749-3	43, 44, 45	ASBT-1000-N	6
688385-1	47	83589-2	22	83749-4	44, 45	ASBT-1000-U	7
688652-1	47	83589-3	22	83750-1	43, 44, 45	ASBT-1250-2	6
688653-1	47	83589-4	22	83750-2	43, 44, 45	ASBT-1250-2-N	6
688654-1	47	83589-6	22	83750-2	43, 44, 45	ASBT-2-350	6
688655-1	47	83589-7	22	83750-3	44, 45	ASBT-2-4/0-U	7
688656-1	47	83590-1	22	83750-4	43, 44, 45	ASBT-250-350-U	7
688657-1	47	83590-2	22	83750-5	43, 44, 45	ASBT-350-500-U	7
69338-1	30	83590-3	22	83750-6	43, 44, 45	ASBT-600-750-U	7
69338-2	30	83590-4	22	83751-1	43, 44, 45	AT-15	256
69338-4	30	83591-1	22	83751-2	43, 44, 45	AT-168	256
69338-5	30	83591-2	22	83751-3	43, 44, 45	AT-19	256
69610-2	30	83591-3	22	83751-4	43, 44, 45	AT-20	256
69633-2	29	83591-4	22	83843-1	25, 51	AT-30	256
69674	32	83592-1	34, 36	83843-2	25, 26, 51	AT-368	256
69685-1	31	83592-2	34, 36	83843-3	23, 25	AT-39	256
69833-1	32	83592-3	34, 36	83843-4	23, 25	BBIT-100/40-A/U	272
7060-VPS	262	83592-4	34, 36	83843-5	23, 24	BBIT-150/60-A/U	272
7090-VPS	262	83592-5	34, 36	83843-6	23, 24	BBIT-175/80-A/U	272
7090-VPS-BK	262	83592-6	34, 36	83843-7	23, 25	BBIT-25/10-A/U	272
710723-3	23	83592-7	34, 36	83861-1	18	BBIT-40/16-A/U	272
710731-5	23	83592-8	34, 36	881224-1	47	BBIT-65/25-A/U	272
734045-1	315	83592-9	34, 36	881225-1	47	BCAC-5D/8-01(B12)	277
734587-1	316	83623-1	35, 36	881226-1	47	BCAC-7D/10-01(B6)	277
80408-2	41	83623-2	35, 36	881781-1	47	BCAC-8D/14-01(B6)	277
80408-3	41	83623-3	35, 36	881783-1	47	BCAC-BYPASS-01(B1)	277
80408-4	41	83623-4	35, 36	881785-1	47	BCAC-BYPASS-02(B1)	277
80408-5	41	83623-5	35, 36	881787-1	47	BCAC-G-4D/13-2 (B18)	290
80408-6	41	83623-6	35, 36	881789-1	47	BCAC-G-5D/8-01 (B12)	290, 277
80408-7	41	83623-7	35, 36			BCAC-G-7D/10-01(B6)	277
80408-8	41	83623-8	35, 36			BCAC-G-8D/14-01(B6)	277
80665-2	30	83623-9	35, 36	A		BCAC-G-AR-3.75D-2 (B24)	290
80665-3	30	83630-1	35, 36	AA-105	257	BCAC-G-AR-4D-2 (B24)	290
8090-VFS	263	83630-2	35, 36	AA-105HA	257	BCAC-G-AR-5D-2 (B24)	290
81673-1	18	83630-3	35, 36	AA-105M	257	BCAC-G-ARM-01 (B12)	289
81673-2	18	83630-4	35, 36	AA-105W	257	BCAC-G-CUTOUT-100-01-B12	290
81673-3	18	83630-5	35, 36	AA-1068	257	BCAC-G-CUTOUT-100-P2-B12	290
81698-1	18	83630-6	35, 36	AA-1068M	257	BCAC-G-CUTOUT-FT (B3)	290
81723-1	39	83630-7	35, 36	AA-1068W	257	BCAC-G-CUTOUT-FT-P (B3)	290
				AA-305	257		

Catalog Number	Page	Catalog Number	Page	Catalog Number	Page	Catalog Number	Page
BCAC-G-IC-10.5D/20 (B6)	278	BISC-SG-201-SCE(B3)	283	CC26-38-SN-M10	317	CRSM 198/55-1200	116
BCAC-G-IC-5D/6 (B6)	278	BCIC-TR205-L (B3)	284	CC26-38-SN-M12	317	CRSM 34/10-1200	116
BCAC-G-IC-7D/12 (B6)	278	BCIC-TR205-R (B3)	284	CC26-38-SN-M12	319	CRSM 34/10-200	116
BCAC-G-IC-8D/18 (B6)	278	BF-120	258	CC26-38-SN-M12-DOUB	318	CRSM 53/13-1200	116
BCAC-G-IC-BYPASS-01 (B1)	278	BF-208-277	258	CC38-50-FM-M12	317	CRSM 53/13-200	116
BCAC-IC-10.5D/20 (B6)	278	BF-PV	258	CC38-50-FM-M12	319	CRSM 84/20-1200	116
BCAC-IC-5D/6 (B6)	278	BISG-100/400 (B3)	276	CC38-50-PL-M12	317, 319	CRSM 84/20-750	116
BCAC-IC-7D/12 (B6)	278	BISG-24-01 (B10)	276	CC38-50-PL-M12-DOUB	318	CRSM-107/29-1000	233
BCAC-IC-8D/18 (B6)	278	BISG-60/115-02(S10)	276	CC38-50-SN-M12	317, 319	CRSM-107/29-1200	233
BCAC-IC-BYPASS-01 (B1)	278	BISG-60/115-03-HOT (B10)	276	CC38-50-SN-M12-DOUB	318	CRSM-143/36-1200	233
BCAC-P-IC-5D/6 (B6)	290	BISG-G-100/400 (B3)	276	CC50-60-FM-M12	317, 319	CRSM-198/55-1200	233
BCIC-0270-SCE (B3)	281	BISG-G-24-01 (B10)	276	CC50-60-PL-M12	317, 319	CRSM-34/10-1200	233
BCIC-0370-SCE (B3)	282	BISG-G-60/115-02(S10)	276	CC50-60-PL-M12-DOUB	318	CRSM-34/10-200	233
BCIC-10D/18 (B3)	281	BISG-G-60/115-03-HOT-B10	276	CC50-60-SN-M12	317, 319	CRSM-53/13-1200	233
BCIC-10D/18-3 (B3)	281	BP-46	275	CC50-60-SN-M12-DOUB	318	CRSM-53/13-200	233
BCIC-11.5D/22(B3)	285	BPTM-100/40-A/U(B50)	272	CC60-70-FM-M12	317, 319	CRSM-84/20-1000	233
BCIC-115-PH (B1)	294	BPTM-120/50-A/U(B50)	272	CC60-70-PL-M12	317, 319	CRSM-84/20-1200	233
BCIC-12/12/5-H (B3)	282	BPTM-15/6-A/U	272	CC60-70-PL-M12-DOUB	318	CRSM-84/20-750	233
BCIC-13D/13-HO (B3)	283	BPTM-175/70-A/U(B50)	272	CC60-70-SN-M12	317, 319	CRSM-CT-34/10-150	117
BCIC-14/19/6-U (B3)	282	BPTM-205/110-A/U(B50)	272	CC60-70-SN-M12-DOUB	318	CRSM-CT-53/13-200	117
BCIC-24/11/12 (B3)	282	BPTM-235/130-A/U-C(40)	272	CC68-81-FM-M12	317, 319	CRSM-CT-53/13-200	117
BCIC-3212-01 (B3)	284	BPTM-30/12-A/U(B50)	272	CC68-81-PL-M12	317, 319	CRSM-CT-84/20-250	117
BCIC-3D/6-3 (B3)	280	BPTM-50/20-A/U(B50)	272	CC68-81-PL-M12-DOUB	318	CSBS-1000-1250	5
BCIC-4/12/4-H (B3)	282	BPTM-75/30-A/U(B50)	272	CC68-81-SN-M12	317, 319	CSBS-2-250	5
BCIC-4/16/4-H (B3)	282	BR 240-35	13	CC68-81-SN-M12-DOUB	318	CSBS-2/0-500-CPR	5
BCIC-4411 (B3)	279	BRKT-1-SS	307	CC80-92-FM-M12	317, 319	CSBS-2/0C-500C	5
BCIC-4D/4 (B3)	283	BRKT-2-SS	307	CC80-92-PL-M12	317, 319	CSBS-2000	5
BCIC-5.5D/11-H0(B3)	281	BRKT-3-SS	307	CC80-92-PL-M12-DOUB	318	CSBS-300-750	5
BCIC-5.5D/16-HO (B3)	280	BRKT-4-SS	307	CC80-92-SN-M12	317, 319	CSBS-300C-750C	5
BCIC-5.5D/60	285			CC80-92-SN-M12-DOUB	318	CSBS-500-1000	5
BCIC-5.5D/60(B3)	285	C		CC92-106-FM-M12	317, 319	CSJ-EG-1	159
BCIC-5D/6 (B3)	283	CA7476-000	314	CC92-106-PL-M12	317, 319	CSJ-EG-2	159
BCIC-5D/8/11 (B6)	291	CA7478-000	314	CC92-106-PL-M12-DOUB	318	CSJ-EG-3	159
BCIC-7.5D/18-3 (B3)	283	CATJ-1581M0	185	CC92-106-SN-M12	317, 319	CSJ-EG-4	159
BCIC-7/12/7-H (B3)	282	CATJ-1582M1	185	CC92-106-SN-M12-DOUB	318	CSJA-1521	160
BCIC-8.25D/8	281	CATJ-1583M2	185	CFTS-1	243	CSJA-1521M1	160
BCIC-8/12/2-U(B3)	282	CATJ-1584M3	185	CFTS-2	243	CSJA-1521M4	160
BCIC-8D/15-HO (B3)	280	CATJ-2881M0	185	CFTS-3	243	CSJA-1521M5	160
BCIC-8D/18-HO (B3)	280	CATJ-2882M1	185	CFTS-4	243	CSJA-1522	160
BCIC-8D/6 (B3)	282	CATJ-2883M2	185	CFTS-5	243	CSJA-1522M1	160
BCIC-8D/6-3 (B3)	280	CATJ-2884M3	185	CJ-250-3W3W-CU-FT-B1	131	CSJA-1522M2	160
BCIC-9D/19-3 (B3)	279	CATJ-T-1581M0	186	CJ-250-5W5W-CU-FT-B1	131	CSJA-1522M6	160
BCIC-ANGLE-4X48 (B6)	287	CATJ-T-1582M1	186	CJ-250-7W7W-CU-FT-B1	131	CSJA-1522M7	160
BCIC-BYPASS (B1)	284, 285	CATJ-T-1583M2	186	CJ-350-3W3W-CU-FT-B1	131	CSJA-1523	160
BCIC-Collar-50/280-5-B	294	CATJ-T-1584M3	186	CJ-350-5W5W-CU-FT-B1	131	CSJA-1523M2	160
BCIC-G-4D/48-01(B4)	285	CATJ-T-2883M2	186	CJ-350-7W7W-CU-FT-B1	131	CSJA-1523M8	160
BCIC-G-ANGLE-4X48 (B6)	287	CATJ-T-2884M3	186	CJ-4/0-3W3W-CU-FT-B1	131	CSJA-1524	160
BCIC-G-DE/CL-01 (B6)	288	CBR-2-1-A	244	CJ-4/0-3W3W-CU-FT-B1	131	CSJA-1524M9	160
BCIC-G-DPIN-556-01 (B6)	288	CBR-2-2-A	244	CJ-4/0-5W5W-CU-FT-B1	131	CSJA-2822	160
BCIC-G-DPIN-795-01 (B6)	288	CBR-2-3-A	244	CJ-4/0-7W7W-CU-FT-B1	131	CSJA-2822M1	160
BCIC-G-DSMPIN-795-01 (B6)	288	CBR-3-1-A	244	CJ-500-3W3W-CU-FT-B1	131	CSJA-2822M5	160
BCIC-G-HZ-795-XL (B6)	288	CBR-3-2-A	244	CJ-500-5W5W-CU-FT-B1	131	CSJA-2822M6	160
BCIC-G-HZPOR/3.5D-795-01 (B6)	288	CBR-3-3-A	244	CJ-500-7W7W-CU-FT-B1	131	CSJA-2823	160
BCIC-G-HZPOR/4.5D-795-01 (B6)	288	CBR-3-4-A	244	CJ-750-3W3W-CU-FT-B1	131	CSJA-2823M2	160
BCIC-G-Recloser-100 (B30)	291	CBR-4-1-A	244	CJ-750-5W5W-CU-FT-B1	131	CSJA-2823M8	160
BCIC-G-Recloser-200 (B6)	291	CBR-4-2-A	244	CJ-750-7W7W-CU-FT-B1	131	CSJA-2824	160
BCIC-G-Recloser-200S (B6)	291	CBR-4-3-A	244	CPGI-ALR-ACL-11	267	CSJA-2824M2	160
BCIC-G-Reclosercover (B6)	291	CBR-4-4-A	244	CPGI-ALR-OLC-5C	267	CSJA-2824M8	160
BCIC-GT-DPIN (B6)	289	CBR-6-1-A	244	CPGI-ALR-PL-120S	267	CSJA-2824M9	160
BCIC-GT-HZ (B6)	289	CBR-6-2-A	244	CPGI-ALR-PL-120S-B	267	CSJA-3-1521-ARMR	166
BCIC-GT-PIN (B6)	289	CC15-26-FM-M12	317	CRPS-2120	248	CSJA-3-1521-TECK	158
BCIC-GT-PIN-XL (B6)	289	CC15-26-PL-M12-DOUB	318	CRPS-248	248	CSJA-3-1521M1-ARMR	166
BCIC-GT-PIN/CT (B6)	289	CC15-26-SN-M10	317	CRPS-260	248	CSJA-3-1521M1-TECK	158
BCIC-Recloser-100 (B6)	291	CC15-26-SN-M12	317	CRPS-290	248	CSJA-3-1521M4-ARMR	166
BCIC-Recloser-200S (B6)	291	CC15-26-SN-M12-DOUB	318	CRSM 107/29-1000	116	CSJA-3-1521M4-TECK	158
BCIC-Reclosercover (B6)	291	CC26-38-FM-M12	317, 319	CRSM 107/29-1200	116	CSJA-3-1521M5-ARMR	166
BCIC-SG-101-H2 (B3)	279	CC26-38-PL-M12-DOUB	318	CRSM 143/36-1200	116	CSJA-3-1521M5-TECK	158

Catalog Number	Page	Catalog Number	Page	Catalog Number	Page	Catalog Number	Page
CSJA-3-1522-ARMR	166	CSJA-JCN/EG-3514	162	CSJU-2511-ALCO	167	ELB-15-200-IC	208
CSJA-3-1522-TECK	158	CSJA-JCN/EG-3514M2	162	CSJU-2511-ALC1	167	ELB-15/28-200-ETP15	209
CSJA-3-1522M1-ARMR	166	CSJA-JCN/EG-3514M8	162	CSJU-2511-ALC2	167	ELB-15/28-200-ETP25	209
CSJA-3-1522M1-TECK	158	CSJA-JCN/EG-3514M9	162	CSJU-2511-ALC3	167	ELB-15/28-200-LRTP15	210
CSJA-3-1522M2-ARMR	166	CSJA-JCN/EG-3515	162	CSJU-2511-SB1	167	ELB-15/28-200-LRTP25	210
CSJA-3-1522M2-TECK	158	CSJA-JCN/EG-3515M10	162	CSJU-2511-SB2	167	ELB-15/28-600-CP-AL	193
CSJA-3-1522M6-ARMR	166	CSJA-JCN/EG-3515M9	162	CST-152	180	ELB-15/28-600-IC	192
CSJA-3-1522M6-TECK	158	CSJD-1521-A1	184	CST-153	180	ELB-15/28-600-J2-AL	195
CSJA-3-1522M7-ARMR	166	CSJD-1521-C1	184	CST-154	180	ELB-15/28-600-J2-AL-ADJ	195
CSJA-3-1522M7-TECK	158	CSJD-1521-C2	184	CST-282	180	ELB-15/28-600-J2-AL-STD	195
CSJA-3-1523-ARMR	166	CSJD-1523-A2	184	CST-283	180	ELB-15/28-600-J3-AL	195
CSJA-3-1523-TECK	158	CSJD-1523-C3	184	CST-284	180	ELB-15/28-600-J3-AL-ADJ	195
CSJA-3-1523M3-ARMR	166	CSJD-1524-A3	184	CST-352	180	ELB-15/28-600-J3-AL-STD	195
CSJA-3-1523M3-TECK	158	CSJD-1524-C4	184	CST-353	180	ELB-15/28-600-J4-AL	195
CSJA-3-1523M8-ARMR	166	CSJD-2821-A1	184	CST-354	180	ELB-15/28-600-J4-AL-ADJ	195
CSJA-3-1523M8-TECK	158	CSJD-2821-C1	184	CSTI-152	178	ELB-15/28-600-J4-AL-STD	195
CSJA-3-2822-ARMR	166	CSJD-2823-A1	184	CSTI-153	178	ELB-15/28-600-SP	191
CSJA-3-2822M1-ARMR	166	CSJD-2823-A2	184	CSTI-154	178	ELB-15/28-600-T1WAY	196
CSJA-3-2822M5-ARMR	166	CSJD-2823-C2	184	CSTI-282	178	ELB-15/28-600-T2WAY	196
CSJA-3-2822M6-ARMR	166	CSJD-2823-C3	184	CSTI-283	178	ELB-15/28-600-T3WAY	196
CSJA-3-2823-ARMR	166	CSJD-2824-A2	184	CSTI-284	178	ELB-15/28-600-T4WAY	196
CSJA-3-2823M2-ARMR	166	CSJD-2824-A3	184	CSTI-352	178	ELB-15/28-610-T1WAY	196
CSJA-3-2823M8-ARMR	166	CSJD-2824-C4	184	CSTI-353	178	ELB-15/28-610-T2WAY	196
CSJA-3-3523-ARMR	166	CSJG-1511	164	CSTI-354	178	ELB-15/28-610-T3WAY	196
CSJA-3-3523M1-ARMR	166	CSJG-1511M1	164	CSTIL-154	178	ELB-15/28-610-T4WAY	196
CSJA-3-3523M5-ARMR	166	CSJG-1511M4	164	CSTIL-284	178	ELB-15/28-900-CP-CU	193
CSJA-3-3524-ARMR	166	CSJG-1511M5	164	CSTO-152	178	ELB-15/28-900-J2-CU	195
CSJA-3-3524M2-ARMR	166	CSJG-1512	164	CSTO-153	178	ELB-15/28-900-J2-CU-ADJ	195
CSJA-3-3524M8-ARMR	166	CSJG-1512M1	164	CSTO-154	178	ELB-15/28-900-J2-CU-STD	195
CSJA-3523	160	CSJG-1512M2	164	CSTO-282	178	ELB-15/28-900-J3-CU	195
CSJA-3523M1	160	CSJG-1512M6	164	CSTO-283	178	ELB-15/28-900-J3-CU-ADJ	195
CSJA-3523M5	160	CSJG-1512M7	164	CSTO-284	178	ELB-15/28-900-J3-CU-STD	195
CSJA-3524	160	CSJG-1513	164	CSTO-352	178	ELB-15/28-900-J4-CU	195
CSJA-3524M2	160	CSJG-1513M2	164	CSTO-353	178	ELB-15/28-900-J4-CU-ADJ	195
CSJA-3524M8	160	CSJG-1513M8	164	CSTO-354	178	ELB-15/28-900-J4-CU-STD	195
CSJA-3524M9	160	CSJG-1514	164	CSTOL-154	178	ELB-200-CES-GRD-1	206
CSJA-3525	160	CSJG-1514M9	164	CSTOL-284	178	ELB-200-GRD-1	206
CSJA-3525M10	160	CSJG-2812	164	CU7208-000	294	ELB-200-GRD-2	206
CSJA-821	160	CSJG-2812M1	164			ELB-25-200-BI	207
CSJA-JCN/EG-1511	162	CSJG-2812M5	164	D		ELB-25-200-BI-IND	207
CSJA-JCN/EG-1511M1	162	CSJG-2812M6	164	DR 240X1	13	ELB-25-200-IC	208
CSJA-JCN/EG-1511M4	162	CSJG-2813	164			ELB-35-200-ETP21	209
CSJA-JCN/EG-1511M5	162	CSJG-2813M2	164	E		ELB-35-200-IC21	208
CSJA-JCN/EG-1512	162	CSJG-2813M8	164	E4540-1250	310	ELB-35-200-LRTP21	210
CSJA-JCN/EG-1512M1	162	CSJG-2814	164	E7512-0160	310	ELB-35-600-ARSTR-27	197
CSJA-JCN/EG-1512M2	162	CSJG-2814M2	164	E7512-0220	310	ELB-35-600-ARSTR-30	197
CSJA-JCN/EG-1512M6	162	CSJG-2814M8	164	E7512-0240	310	ELB-35-600-ARSTR-33	197
CSJA-JCN/EG-1512M7	162	CSJG-2814M9	164	E7512-0260	310	ELB-35-600-GRD2	206
CSJA-JCN/EG-1513	162	CSJG-3513	164	EAKT 1521	307	ELB-35-600-GRD3	206
CSJA-JCN/EG-1513M2	162	CSJG-3513M1	164	EAKT 1523	307	ELB-35-600-GRD	206
CSJA-JCN/EG-1513M8	162	CSJG-3513M5	164	EAKT 1524	307	ELB-35-600-ARSTR-36	197
CSJA-JCN/EG-1514	162	CSJG-3514	164	EHVS-6920-W-CXXX	216	ELB-35-600-CP-AL	193
CSJA-JCN/EG-1514M9	162	CSJG-3514M2	164	EHVS-6921-W-CXXX	216	ELB-35-600-GRD1	206
CSJA-JCN/EG-2812	162	CSJG-3514M8	164	EHVS-6922-W-CXXX	216	ELB-35-600-J2-AL	195
CSJA-JCN/EG-2812M1	162	CSJG-3514M9	164	EHVS-6923-W-CXXX	216	ELB-35-600-J2-AL-ADJ	195
CSJA-JCN/EG-2812M5	162	CSJG-3515	164	EHVT-462-G	217	ELB-35-600-J2-AL-STD	195
CSJA-JCN/EG-2812M6	162	CSJG-3515M10	164	EHVT-463-G	217	ELB-35-600-J3-AL	195
CSJA-JCN/EG-2813	162	CSJU-1511	167	EHVT-464-G	217	ELB-35-600-J3-AL-ADJ	195
CSJA-JCN/EG-2813M2	162	CSJU-1511-ALCO	167	EHVT-465-G	217	ELB-35-600-J3-AL-STD	195
CSJA-JCN/EG-2813M8	162	CSJU-1511-ALC1	167	EHVT-465-G	217	ELB-35-600-J4-AL	195
CSJA-JCN/EG-2814	162	CSJU-1511-ALC2	167	EHVT-690-G	217	ELB-35-600-J4-AL-ADJ	195
CSJA-JCN/EG-2814M2	162	CSJU-1511-ALC3	167	EHVT-691-G	217	ELB-35-600-J4-AL-STD	195
CSJA-JCN/EG-2814M8	162	CSJU-1511-ALC4	167	EHVT-692-G	217	ELB-35-600-SP	191
CSJA-JCN/EG-2814M9	162	CSJU-1511-ALC5	167	EHVT-693-G	217	ELB-35-600-T1WAY	196
CSJA-JCN/EG-3513	162	CSJU-1511-SB1	167	EHVT-694-G	217	ELB-35-600-T2WAY	196
CSJA-JCN/EG-3513M1	162	CSJU-1511-SB2	167	EHVT-BP	224	ELB-35-600-T3WAY	196
CSJA-JCN/EG-3513M5	162	CSJU-2511	167	ELB-12-200-BI-IND	207	ELB-35-610-T1WAY	196
				ELB-15-200-BI	207	ELB-35-610-T2WAY	196

Catalog Number	Page	Catalog Number	Page	Catalog Number	Page	Catalog Number	Page
HVIA-CABLE-HEATING-BLANKET	225	HVS-3511S-J	136	HVS-LR-200/50-600	232, 306	HVSY-1524S	154
HVIA-SLIDE-RAIL-1580	225	HVS-3512S-J	136	HVS-LR-75/15-1200	232, 306	HVSY-1582D	154, 155
HVIA-Stripper 35/90-US	224	HVS-3513S-J	136	HVS-LR-75/15-600	232, 306	HVSY-1583D	154, 155
HVIA-Stripper 75/150-US	224	HVS-3521S	140, 147, 148	HVS-MESH-2-5000	304	HVT-1591-G	176
HVIS-05-(B3) NS	273	HVS-3522S	140, 147, 148	HVS-S-1512S-J-M4	135	HVT-1591-SG	176
HVIS-10-(B1) NS	273	HVS-3523S	140, 147, 148	HVS-S-1512S-J-M5	135	HVT-1592-G	176
HVIS-Angle (B12)	273	HVS-3524S	140, 147, 148	HVS-S-1513S-J-M6	135	HVT-1592-SG	176
HVIS-Clamp (B25)	273	HVS-3531-LC	142	HVS-S-1514S-J-M8	135	HVT-1593-G	176
HVIS-Flat (B12)	273	HVS-3532-LC	142	HVS-S-1514S-J-M9	135	HVT-1593-SG	176
HVLB-C-S-X-6-Y-U-IP68-B-Z	223	HVS-3533-LC	142	HVS-S-1522S-M4	139	HVT-1594-G	176
HVLB-E-S-O-1-Y-U-IP68-B-Z	223	HVS-3582D	149	HVS-S-1522S-M5	139	HVT-1594-SG	176
HVLB-E-S-O-3-Y-U-IP68-B-Z	223	HVS-3583D	149	HVS-S-1523S-M6	139	HVT-3-1591-G	176
HVLB-E-S-X-1-Y-U-IP68-B-Z	223	HVS-3584D	149	HVS-S-1524S-M8	139	HVT-3-1591-SG	176
HVLB-E-S-X-3-Y-U-IP68-B-Z	223	HVS-501	134, 147, 148	HVS-S-1524S-M9	139	HVT-3-1592-G	176
HVS-1521S	140, 147, 148	HVS-502	134, 147, 148	HVS-S-1531S-M4	141	HVT-3-1592-SG	176
HVS-1521S-W	140, 147, 148	HVS-503	134, 147, 148	HVS-S-1532S-M5	141	HVT-3-1593-G	176
HVS-1522S-W	140	HVS-821S	140, 147, 148	HVS-S-1533S-M6	141	HVT-3-1593-SG	176
HVS-1523S	140, 147, 148	HVS-822S	140, 147, 148	HVS-S-1534S-M8	141	HVT-51	168
HVS-1523S-W	140	HVS-823S	140, 147, 148	HVS-S-1534S-M9	141	HVT-52	168
HVS-1524S	140, 147, 148	HVS-824S	140, 147, 148	HVS-SHIM-1	144	HVT-53	168
HVS-1524S-W	140	HVS-825S	140, 147, 148	HVS-SHIM-2	144	HVT-M-151	177
HVS-1525S	140	HVS-C-1511S-J	135	HVS-SHIM-3	144	HVT-M-151-S	177
HVS-1525S-W	140	HVS-C-1512S-J	135	HVS-SHIM-4	144	HVT-M-152	177
HVS-1581D	149	HVS-C-1512S-J-M1	135	HVS-SHIM-5	144	HVT-M-152-S	177
HVS-1582D	149	HVS-C-1512S-RJ-M4	137	HVS-SHIM-6	144	HVT-M-251	177
HVS-1583D	149	HVS-C-1512S-RJ-M5	137	HVS-T-1581E-S	151	HVT-M-251-S	177
HVS-1584D	149	HVS-C-1513S-J	135	HVS-T-1581S	151	HVT-M-252	177
HVS-2511E-J	136	HVS-C-1513S-J-M2	135	HVS-T-1582E-S	151	HVT-M-252-S	177
HVS-2512E-J	136	HVS-C-1513S-RJ-M7	137	HVS-T-1582S	151	HVT-M-581	177
HVS-2513E-J	136	HVS-C-1514S-J	135	HVS-T-1583E-S	151	HVT-M-581-S	177
HVS-2521S	140, 147, 148	HVS-C-1514S-RJ-M8	137	HVS-T-1583S	151	HVT-M-582	177
HVS-2522S	140, 147, 148	HVS-C-1514S-RJ-M9	137	HVS-T-1584S	151	HVT-M-582-S	177
HVS-2523S	140, 147, 148	HVS-C-1521S	138	HVS-T-1591S	152	HVT-M-583	177
HVS-2531-LC	142	HVS-C-1522S	138	HVS-T-1592S	152	HVT-M-583-S	177
HVS-2532-LC	142	HVS-C-1522S-M1	138	HVS-T-1593S	152	HVT-Z-151-G	170, 172
HVS-2533-LC	142	HVS-C-1522S-RJ-M4	137	HVS-T-2582E	151	HVT-Z-151-G-T5	171
HVS-2582E	149	HVS-C-1522S-RJ-M5	137	HVS-T-2583E	151	HVT-Z-151-J	169
HVS-2583E	149	HVS-C-1523S	138	HVS-T-2584E	151	HVT-Z-151-LC	174
HVS-2584E	149	HVS-C-1523S-M2	138	HVS-T-3582S	151	HVT-Z-151-SG	170, 172
HVS-3-1521S	145, 146	HVS-C-1523S-RJ-M7	137	HVS-T-3583S	151	HVT-Z-151-SG-T5	171
HVS-3-1522S	145, 146	HVS-C-1524S	138	HVSA-3-1521S-TECK	143	HVT-Z-151-SJ	169
HVS-3-1523S	145, 146	HVS-C-1524S-RJ-M8	137	HVSA-3-1522S-TECK	143	HVT-Z-151-SLC	174
HVS-3-1524S	145, 146	HVS-C-1524S-RJ-M9	137	HVSA-3-1523S-TECK	143	HVT-Z-152-G	170, 172
HVS-3-1581S	153	HVS-C-1531S	141	HVSA-3-1524S-TECK	143	HVT-Z-152-G-T5	171
HVS-3-1582S	153	HVS-C-1532S	141	HVSA-3-1581S	153	HVT-Z-152-J	169
HVS-3-1583S	153	HVS-C-1532S-M1	141	HVSA-3-1582S	153	HVT-Z-152-LC	174
HVS-3-1584S	153	HVS-C-1533S	141	HVSA-3-1583S	153	HVT-Z-152-SG	170, 172
HVS-3-1591	150	HVS-C-1533S-M2	141	HVSA-3-1584S	153	HVT-Z-152-SG-T5	171
HVS-3-1591S	150	HVS-C-1534S	141	HVSA-3-501	134	HVT-Z-152-SJ	169
HVS-3-1592	150	HVS-C-2511S-RJ-M4	137	HVSA-3-502	134	HVT-Z-152-SLC	174
HVS-3-1592S	150	HVS-C-2512S-RJ-M5	137	HVSA-3-503	134	HVT-Z-153-G	170, 172
HVS-3-1593	150	HVS-C-2513S-RJ-M8	137	HVSH-1522-MOD	155	HVT-Z-153-G-T8	171
HVS-3-1593S	150	HVS-C-2514S-RJ-M9	137	HVSH-1523-MOD	155	HVT-Z-153-G-T9	171
HVS-3-1594	150	HVS-C-2521S-RJ-M4	137	HVSH-1582D-MOD	155	HVT-Z-153-J	169
HVS-3-2521S	145	HVS-C-2522S-RJ-M5	137	HVSH-1583D-MOD	155	HVT-Z-153-LC	174
HVS-3-2522S	145	HVS-C-2523S-RJ-M8	137	HVSR-1582	149	HVT-Z-153-SG	170, 172
HVS-3-2523S	145	HVS-C-2524S-RJ-M9	137	HVSR-1583	149	HVT-Z-153-SG-T8	171
HVS-3-2591E	150	HVS-EG-3-1	139	HVSR-1584	149	HVT-Z-153-SG-T9	171
HVS-3-2592E	150	HVS-EG-3-2	139	HVSR-2583E	149	HVT-Z-153-SJ	169
HVS-3-501	134	HVS-EG-3-3	139	HVSR-2584E	149	HVT-Z-153-SLC	174
HVS-3-502	134	HVS-GC-0.5	305	HVSR-T-1582	151	HVT-Z-154-G	170, 172
HVS-3-503	134	HVS-GC-1.0	305	HVSR-T-1583	151	HVT-Z-154-J	169
HVS-3-821S	145, 146	HVS-GC-1.5	305	HVSR-T-1584	151	HVT-Z-154-LC	174
HVS-3-822S	145, 146	HVS-LR-160/42-1200	232	HVSR-T-2582E	151	HVT-Z-154-SG	170, 172
HVS-3-823S	145, 146	HVS-LR-160/42-1200	306	HVSR-T-2583E	151	HVT-Z-154-SJ	169
HVS-3-824S	145, 146	HVS-LR-160/42-600	232, 306	HVSY-1522S	154, 155	HVT-Z-154-SLC	174
HVS-3-825S	145, 146	HVS-LR-200/50-1200	232, 306	HVSY-1523S	154, 155	HVT-Z-252/352-G	170, 172

Catalog Number	Page	Catalog Number	Page	Catalog Number	Page	Catalog Number	Page
HVT-Z-252/352-G-T5	171	IDP-HLX125WE2NEL60S	101	IDP-WP-165051-25-9	104	LV-MSK-045(B20)	119
HVT-Z-252/352-J	169	IDP-HLX125WE4NEL60S	101	IDP-WP-165102-10-9	104	LV-MSK-046(B15)	119
HVT-Z-252/352-SG	170, 172	IDP-HLX125YW2NEL60S	101	IDP-WP-178095-10-9	104	LV-MSK-047	119
HVT-Z-252/352-SG-T5	171	IDP-HLX125YW4NEL60S	101	IDP-WP-191064-10-9	104	LV-MSK-058	119
HVT-Z-252/352-SJ	169	IDP-MP-101635-2.5-8A	104	IDP-WP-203127-10-9	104	LVBT-1-R	250
HVT-Z-253/353-G	170, 172	IDP-MP-191064-10-8A	104	IDP-WP-229064-10-9	104	LVBT-2-R	250
HVT-Z-253/353-G-T5	171	IDP-MP-203127-10-8A	104	IDP-WP-254097-10-9	104	LVBT-4-R	250
HVT-Z-253/353-G-T8	171	IDP-MP-254127-10-8A	104	IDP-WP-254127-10-9	104	LVIT-150/50-A/U	242
HVT-Z-253/353-J	169	IDP-MP-254254-10-8A	104	IDP-WP-254254-10-9	104	LVIT-30/10-A/U	242
HVT-Z-253/353-SG	170, 172	IDP-MP-381064-10-8A	104	IDP-WP-318064-10-9	104	LVIT-75/25-A/U	242
HVT-Z-253/353-SG-T5	171	IDP-MP-381191-5-8A	104	IDP-WP-381020-10-9	104	LVSA-3-1	115
HVT-Z-253/353-SG-T8	171	IDP-MP-508254-5-8A	104	IDP-WP-381064-10-9	104	LVSA-3-2	115
HVT-Z-253/353-SJ	169	IDP-MP-508318-2.5-8A	104	IDP-WP-381191-5-9	104	LVSA-3-3	115
HVT-Z-254/354-G	170, 172	IDP-MP-699254-5-8A	104	IDP-WP-508064-10-9	104	LVSA-3-4	115
HVT-Z-254/354-G-T9	171	IDP-MP-762381-2.5-8A	104	IDP-WP-508127-5-9	104		
HVT-Z-254/354-J	169	IDP-MP-762508-2.5-8A	104	IDP-WP-508254-5-9	104	M	
HVT-Z-254/354-SG	170, 172	IDP-PM07507	102	IDP-WP-508318-2.5-9	104	M-120	259
HVT-Z-254/354-SG-T9	171	IDP-PM07507-BLANK	102	IDP-WP-523841-1.5-9	104	M-208-277	259
HVT-Z-254/354-SJ	169	IDP-PM09512	102	IDP-WP-700254-5-9	104	M-347	259
HVT-Z-80-G/SG	170, 172	IDP-PM09512-BLANK	102	IDP-WP-762381-2.5-9	104	M-480	259
HVT-Z-81-G/SG	170, 172	IDP-SB050100WE10	103	IDP-WP-762508-2.5-9	104	M-PV	259
HVT-Z-81-G/SG-T5	171	IDP-SB050100WE5-T200	103	IDP-WP-950950-10-9	104	MBSM-125/30-1200	231
HVT-Z-82-G/SG	170, 172	IDP-SB050143WE10	103	IT 1000-002	315	MBSM-160/42-1200	231
HVT-Z-82-G/SG-T5	171	IDP-SB050143WE5-T200	103	IT-1000-006	316	MBSM-200/50-1200	231
HVT-Z-82-G/SG-T8	171	IDP-SB080150WE10	103	IT-1000-019	316	MBSM-43/8-1200	231
HVT-Z-83-G/SG	170, 172	IDP-SB080150WE5-T200	103	IT-1000-030-2	316	MBSM-75/15-1200	231
HVT-Z-83-G/SG-T9	171	IDP-SB100143WE2.5-T200	103	IT-1000-030-2-BLADE	316	MC-10	265
HVT-Z-84-G/SG	170, 172	IDP-SB100143WE5	103	IT-1000-033-UK/US	314	MC-10ANSI	265
HVT-ZL-151-G	175	IDP-SB100225WE2.5-T200	103			MCK-1L	129
HVT-ZL-151-SG	175	IDP-SB100225WE5	103	J		MCK-1V	129
HVT-ZL-152-G	175	IDP-SB100375WE1-T200	103	JGK-MS-1	202	MCK-2L	129
HVT-ZL-152-SG	175	IDP-SB100375WE2.5	103	JGK-MS-1	304	MCK-2V	129
HVT-ZL-153-G	175	IDP-SB100594WE0.5-T200	103	JGK-MS-2	202, 304	MCK-3V	129
HVT-ZL-153-SG	175	IDP-SB100594WE1	103	JGK-MS-3	202, 304	MCK-4V	129
HVT-ZL-154-G	175	IDP-SB190594WE1	103	JGK-MS-HC-2	202	MCK-5-1L	188
HVT-ZL-154-SG	175	IDP-SB200143WE2.5	103	JGK-MS-HC-3	202	MCK-5-1V	188
HVT-ZL-252-G	175	IDP-SB200225WE1-T200	103			MCK-5-2L	188
HVT-ZL-252-SG	175	IDP-SB200225WE2.5	103	K		MCK-5-2V	188
HVT-ZL-253-G	175	IDP-SB200375WE1-T200	103	KMS-K-INT	315	MCK-5-3V	188
HVT-ZL-253-SG	175	IDP-SB200375WE2.5	103	KZ 2-150 2B	13	MH-120	259
HVT-ZL-254-G	175	IDP-SB200743WE0.5-T200	103	KZ 2-150 2Bp	13	MH-208-277	259
HVT-ZL-254-SG	175	IDP-SB200743WE1	103	KZEP-4/0	13	MH-PV	259
HVT-ZL-352-G	175	IDP-SST141-316	102			MOD-3A-HVT	173
HVT-ZL-352-SG	175	IDP-SST71-316	102	L		MOD-3A-HVT (sealed)	172
HVT-ZL-353-G	175	IDP-T200-CUTTER	107	LC-120	258	MOD-3B-HVT	173
HVT-ZL-353-SG	175	IDP-T200-PERFORATOR	107	LC-208-277	258	MOD-3B-HVT (sealed)	172
HVT-ZL-354-G	175	IDP-T200-PRINTER	107	LHM 1R 30/45 - 0-0716541-1	316	MOD-3X-HVT	172
HVT-ZL-354-SG	175	IDP-TE3112-PRINTER	107	LM-1-1/4-SL	106	MOD-3X-HVT (unsealed)	172
HVT-ZL-80-G	175	IDP-TMS-RJS-RIBN-4RPSCE	100	LM-1-SL	106	MOD-3Y-HVT	172
HVT-ZL-80-SG	175	IDP-TMS-RJS-RIBN-4RPSCE	108	LM-1-VINYL-WE	106	MOD-3Y-HVT (unsealed)	172
HVT-ZL-81-G	175	IDP-TTC-PRINT-PERFORATOR	107	LM-1-VINYL-YW	106	MOD-S1-314-Skirts	308
HVT-ZL-81-SG	175	IDP-TTC-PRINTER-CUTTER	107	LM-1/2-SL	106	MOD-S2-325-Skirts	308
HVT-ZL-82-G	175	IDP-TTPA100WE-10	105	LM-1/2-TUBE-WE	106	MOD-S3-336-Skirts	308
HVT-ZL-82-SG	175	IDP-TTPA100YW-10	105	LM-1/2-TUBE-YW	106	MOD-S4-346-Skirts	308
HVT-ZL-83-G	175	IDP-TTPA200MP-10	105	LM-1/2-VINYL-WE	106	MOD-S5-357-Skirts	308
HVT-ZL-83-SG	175	IDP-TTPA200WE-10	105	LM-1/2-VINYL-YW	106	MRS-12-10	118, 234
HVT-ZL-84-G	175	IDP-TTPA300MP-10	105	LM-1/4-TUBE-WE	106	MRS-12-24	118, 234
HVT-ZL-84-SG	175	IDP-TTPA300WE-10	105	LM-1/4-TUBE-YW	106	MRS-34-24	118, 234
		IDP-TTPA400MP-10	105	LM-1/8-TUBE-WE	106	MRS-34-30	118, 234
		IDP-TTPA400WE-10	105	LM-1/8-TUBE-YW	106	MRS-56-30	118, 234
I		IDP-WINTOTAL-6-SWARE-DGL	108	LM-2-1/2-SL	106	MVCC-10/.40 (B100)	287
IDP-1330-0607-10	108	IDP-WP-040040-25-9	104	LM-3/16-TUBE-WE	106	MVCC-19/.75 (B50)	287
IDP-1996-RIBBON	108	IDP-WP-064064-25-9	104	LM-3/16-TUBE-YW	106	MVCC-25/1.0 (B25)	287
IDP-CM-SCE-25-4H-9	101	IDP-WP-080080-10-9	104	LM-3/4-SL	106	MVCC-45/1.75 x 4 (B24)	287
IDP-CM-SCE-50-4H-9	101	IDP-WP-101165-0.85-9	104	LM-4-SL	106	MVCC-G-10/.40 (B100)	287
IDP-CM-SCE-50-6H-9	101	IDP-WP-101635-2.5-9	104	LM-CASE	106	MVCC-G-19/.75 (B50)	287
IDP-CM-SCE-TP-25-4H-9	101	IDP-WP-114040-25-9	104	LM2020PLUS-2500MAH-NICAD	106	MVCC-G-25/1.0 (B25)	287
IDP-CM-SCE-TP-50-4H-9	101	IDP-WP-127111-10-9	104	LM2020PLUS-PRINTER-KIT	106	MVCC-G-45/1.75 x 4 (B24)	287

Catalog Number	Page	Catalog Number	Page	Catalog Number	Page	Catalog Number	Page
MVFT-G-2-12 (B4)	249, 286	RNF-100-1/2-150-(color)	238	SIML 0-711745-1	316	TFT-252E	182
MVLC-14-A/241-C(100)	292	RNF-100-1/2-25-(color)	238	SIML 0-711746-1	316	TFT-252E-SG	182
MVLC-14-A/U-C(100)	292	RNF-100-1/4-25-(color)	238	SIML-1-708052-1	13	TFT-252E-SG-SLC	181
MVLC-18-A/U-C(75)	292	RNF-100-1/4-250-(color)	238	SIML-1727742-1	13	TFT-252E-SLC	182
MVLC-38-A/241-C (50)	292	RNF-100-1/8-25-(color)	238	SL-250-120V-F-01 (B1)	131	TFT-252R-SG	183
MVLC-38R-A/U-C (50)	292	RNF-100-1/8-500-(color)	238	SL-250-120V-NF-FT (B1)	131	TFT-253E	182
MWTM-10/3-1200-S	112, 239	RNF-100-2-25-(color)	238	SL-350-120V-F-01 (B1)	131	TFT-253E-SG	182
MWTM-10/3-A/U	112, 239	RNF-100-3/16-25-(color)	238	SL-350-120V-NF-FT (B1)	131	TFT-253E-SG-SLC	181
MWTM-115/34-1200-S	112, 239	RNF-100-3/32-25-(color)	238	SL-4/0-120V-F-01 (B1)	131	TFT-253E-SLC	182
MWTM-115/34-1500/U	112, 239	RNF-100-3/4-25-(color)	238	SL-4/0-120V-NF-FT (B1)	131	TFT-253R-SG	183
MWTM-140/42-1200-S	112, 239	RNF-100-3/8-200-(color)	238	SL-500-120V-F-01 (B1)	131	TFT-254E	182
MWTM-140/42-1500/U	112, 239	RNF-100-3/8-25-(color)	238	SL-500-120V-NF-FT (B1)	131	TFT-254E-SG	182
MWTM-16/5-1200-S	112, 239	RRBB-2440/1220-6.2-BP	274	SL-750-120V-F-01 (B1)	131	TFT-254E-SG-SLC	181
MWTM-16/5-A/U	112, 239	RRBB-6-1.25Mx1.25M-(B3)	274	SL-750-120V-NF-FT (B1)	131	TFT-254E-SLC	182
MWTM-25/8-1200-S	112, 239	RRGS-35/470-FT (B12)	297	SPT-15	256	TFT-254R-SG	183
MWTM-25/8-A/U	112, 239	RRGS-35/470-M (B12)	297	SPT-168	256	TFT-352E	182
MWTM-35/12-1200-S	112, 239	RRGS-35/600-FT (B3)	297	SPT-19	256	TFT-352E-SG	182
MWTM-35/12-A/U	112, 239	RRGS-35/600-M (B12)	297	SPT-347	256	TFT-352E-SG-SLC	181
MWTM-50/16-1200-S	112, 239	RVC-1V	130	SST-PV	264	TFT-352E-SLC	182
MWTM-50/16-A/U	112, 239	RVC-1V (B5)	130	SST-PV-IES	264	TFT-352R-SG	183
MWTM-85/25-1200-S	112, 239	RVC-2V	130	SST-PV-IES-UL	264	TFT-353E	182
MWTM-85/25-1500/U	112, 239	RVC-2V (B5)	130			TFT-353E-SG	182
		RVC-3V (B5)	130	T		TFT-353E-SG-SLC	181
N		RVC-4V (B5)	130	T200-IDENT-PRINTER	108	TFT-353E-SLC	182
NS-10	265	RVS-11	122	TE3112-PRINTER	108	TFT-353E-T5	181
NS-10ANSI	265	RVS-12	122	TECK-10	143	TFT-353R-SG	183
		RVS-13	122	TECK-11	143	TFT-354E	182
P		RVS-13-SK	201	TECK-12	143	TFT-354E-SG	182
P2B100 U Mk2	13	RVS-14	122	TECK-13	143	TFT-354E-SG-SLC	181
P2G-300	13	RVS-14-SK	201	TECK-14	143	TFT-354E-SLC	182
P2X 150	13	RVS-15-SK	201	TECK-41	143	TFT-354E-T8	181
P2X 95 Mk2	13			TECK-42	143	TFT-354E-T9	181
P31F	13	S		TECK-43	143	TFT-354R-SG	183
P3B120	13	S-1278-3 x 61 x 7620	310	TECK-44	143	TFT-50R	183
P3X 95	13	S1052	252	TECK-531	143	TFT-51R	183
P4X 120D	13	S1052-3-3000-(B5)	252	TECK-532	143	TFT-52R	183
P4X 150D	13	S1085	252	TFT-150R-G	183	TFT-53R	183
P63	305	S1085-3-380 (B15)	252	TFT-151E	182	TFT-P-80R	183
PRINTER-UNIVERSAL-REEL-HOLDER	109	S1171	252	TFT-151E-G	182	TL-115	257
PRINTER-UNIVERSAL-REEL-HOLDER-ADAPTORS	109	S1171-4-300 (B100)	252	TFT-151E-SG	182	TL-1168	257
PT-15	256	S1174	252	TFT-151E-SG-SLC	181		
PT-168	256	S1174-2-300(B25)	252	TFT-151E-SLC	182	U	
PT-20	256	S1174-4-460	252	TFT-151R-G	183	US-30	266
PT-347	256	S1189	252	TFT-151R-SG	183		
		S1189-3-600 (B25)	252	TFT-152E	182	W	
		S1251	252	TFT-152E-G	182	WCSM-110/30-1200-S	113, 240
R		S1251-25-300-4(B25)	252	TFT-152E-SG	182	WCSM-110/30-300-S	113, 240
RBDP-BLA-10D104U	311	S1251-50-300-1(B25)	252	TFT-152E-SG-SLC	181	WCSM-12/3-1200-S	113, 240
RBDP-BLA-12D148U	311	S1278	252	TFT-152E-SLC	182	WCSM-12/3-150-S	113, 240
RBDP-BLA-15D183U	311	S1278-3x61x7620(S1)	252	TFT-152R-G	183	WCSM-12/3-300-S	113, 240
RBDP-BLA-20D236U	311	SC-10A	265	TFT-152R-SG	183	WCSM-130/35-1200-S	113, 240
RBDP-BLA-30D346U	311	SC-10ANSI	265	TFT-153E	182	WCSM-130/35-300-S	113, 240
RBDP-BLA-40D402U	311	Screw Clamps	225	TFT-153E-G	182	WCSM-130/35-450-S	113, 240
RBDP-BLA-50D535U	311	ShrinkMark-10-2-9	100	TFT-153E-SG	182	WCSM-16/4-1200-S	113, 240
RBDP-BLA-60D637U	311	ShrinkMark-10-2-S1-9	100	TFT-153E-SG-SLC	181	WCSM-16/4-150-S	113, 240
RBDP-BLA-80D816U	311	ShrinkMark-1000-2-9	100	TFT-153E-SLC	182	WCSM-16/4-300-S	113, 240
RDSS-AD-210	310	ShrinkMark-1000-2-S1-9	100	TFT-153R-G	183	WCSM-24/6-1200-S	113, 240
RDSS-AT/AP-150	310	ShrinkMark-12-2-9	100	TFT-153R-SG	183	WCSM-24/6-150-S	113, 240
RDSS-CLIP-100	310	ShrinkMark-12-2-S1-9	100	TFT-154E	182	WCSM-24/6-225-S	113, 240
RDSS-CLIP-125	310	ShrinkMark-18-2-9	100	TFT-154E-SG	182	WCSM-24/6-300-S	113, 240
RDSS-CLIP-150	310	ShrinkMark-18-2-S1-9	100	TFT-154E-SG-SLC	181	WCSM-34/8-1200-S	113, 240
RDSS-CLIP-45	310	ShrinkMark-2-2-9	100	TFT-154E-SLC	182	WCSM-34/8-150-S	113, 240
RDSS-CLIP-75	310	ShrinkMark-2-2-S1-9	100	TFT-154R-SG	183	WCSM-34/8-200-S	113, 240
RDSS-IG-SR-AS	310	ShrinkMark-250-2-9	100	TFT-251E	182	WCSM-34/8-225-S	113, 240
RDSS-IT-16	310	ShrinkMark-250-2-S1-9	100	TFT-251E-SG	182	WCSM-34/8-300-S	113, 240
RNF-100-1-1/2-25-(color)	238	SIMIL 0711744-1	316	TFT-251E-SG-SLC	181	WCSM-48/12-1200-S	113, 240
RNF-100-1-25-(color)	238	SIML 0-0711748-1	316	TFT-251E-SLC	182	WCSM-48/12-150-S	113, 240
RNF-100-1/16-25-(color)	238	SIML 0-0711749-1	316	TFT-251R-SG	183	WCSM-48/12-225-S	113, 240

Catalog Number	Page
WCSM-48/12-300-S	113, 240
WCSM-56/16-1200-S	113, 240
WCSM-56/16-225-S	113, 240
WCSM-56/16-300-S	113, 240
WCSM-70/20-1200-S	113, 240
WCSM-70/20-300-S	113, 240
WCSM-70/20-450-S	113, 240
WCSM-70/20-600-S	113, 240

TE Connectivity Ltd. is a \$13 billion global technology and manufacturing leader creating a safer, sustainable, productive, and connected future. For more than 75 years, our connectivity and sensor solutions, proven in the harshest environments, have enabled advancements in transportation, industrial applications, medical technology, energy, data communications, and the home. With 78,000 employees, including more than 7,000 engineers, working alongside customers in nearly 150 countries, TE ensures that EVERY CONNECTION COUNTS. Learn more at www.te.com and on LinkedIn, Facebook, WeChat and Twitter.

- Mining
- Nuclear power plants
- OEMs
- Overhead distribution
- Petrochemical plants
- Railways
- Street lighting
- Substations
- Transmission lines
- Underground distribution
- Windfarms
- Solar
- Hydro-electric

WHEREVER ELECTRICITY FLOWS, YOU'LL FIND TE ENERGY



te.com/energy

**FOR MORE INFORMATION:
TE Technical Support Centers**

France:	+ 33 380 583 212	Poland + Baltics:	+ 48 224 576 753
Germany:	+ 49 896 089 903	Czech Republic:	+ 42 0 272 011 105
UK:	+ 44 8 708 707 500	Sweden/Norway:	+ 46 850 725 057
Spain:	+ 34 916 630 400	Denmark:	+ 45 43 480 424
Middle East:	+ 971 4-2 117 000	USA:	+ 1 800 327 6996

te.com/energy

© 2018 TE Connectivity Ltd. family of companies. All Rights Reserved. EPP-3047-2/18 E361

Bowthorpe EMP, Raychem, Simel, VESA, TE Connectivity and the TE connectivity (logo) are trademarks of the TE Connectivity Ltd. family of companies. Other logos, product and Company names mentioned herein may be trademarks of their respective owners. While TE has made every reasonable effort to ensure the accuracy of the information in this brochure, TE does not guarantee that it is error-free, nor does TE make any other representation, warranty or guarantee that the information is accurate, correct, reliable or current. TE reserves the right to make any adjustments to the information contained herein at any time without notice. TE expressly disclaims all implied warranties regarding the information contained herein, including, but not limited to, any implied warranties of merchantability or fitness for a particular purpose. The dimensions in this brochure are for reference purposes only and are subject to change without notice. Specifications are subject to change without notice. Consult TE for the latest dimensions and design specifications.

